

2014 Disposal-Facility-Based Characterization of Solid Waste in California



California Department of Resources Recycling and Recovery

October 6, 2015

Contractor's Report
Produced Under Contract By:
Cascadia Consulting Group



STATE OF CALIFORNIA

Edmund G. Brown Jr.
Governor

Matt Rodriquez
Secretary, California Environmental Protection Agency

DEPARTMENT OF RESOURCES RECYCLING AND RECOVERY

Scott Smithline
Director

Department of Resources Recycling and Recovery
Public Affairs Office
1001 I Street (MS 22-B)
P.O. Box 4025
Sacramento, CA 95812-4025
www.calrecycle.ca.gov/Publications/
1-800-RECYCLE (California only) or (916) 341-6300

Publication # DRRR-2015-1546



To conserve resources and reduce waste, CalRecycle reports are produced in electronic format only.

If printing copies of this document, please consider use of recycled paper containing 100 percent postconsumer fiber and, where possible, please print images on both sides of the paper.

Copyright © 2015 by the California Department of Resources Recycling and Recovery (CalRecycle). All rights reserved. This publication, or parts thereof, may not be reproduced in any form without permission.

Prepared as part of contract number DRR-12059 (total contract amount: \$1,911,500.46, includes other services not related to this report).

The California Department of Resources Recycling and Recovery (CalRecycle) does not discriminate on the basis of disability in access to its programs. CalRecycle publications are available in accessible formats upon request by calling the Public Affairs Office at (916) 341-6300. Persons with hearing impairments can reach CalRecycle through the California Relay Service, 1-800-735-2929.

Disclaimer: This report was produced under contract by Cascadia Consulting Group. The statements and conclusions contained in this report are those of the contractor and not necessarily those of the Department of Resources Recycling and Recovery (CalRecycle), its employees, or the State of California and should not be cited or quoted as official Department policy or direction.

The state makes no warranty, expressed or implied, and assumes no liability for the information contained in the succeeding text. Any mention of commercial products or processes shall not be construed as an endorsement of such products or processes.

Table of Contents

Table of Tables	iii
Table of Figures	vi
Acknowledgments.....	vii
Executive Summary	1
Introduction and Objectives	1
Study Methodology	1
Results	2
Key Findings	9
Comparison with 2008 Statewide Waste Characterization Study	9
Introduction and Overview	11
Relation to Previous Studies.....	11
Objectives and General Methodology of the 2014 Study.....	12
Identifying Regions	13
Defining Waste Sectors	15
Scheduling Sites	16
Selecting Material Types.....	17
Determining the Composition of the Waste Stream.....	18
Quantifying the Waste Stream.....	19
Interpreting the Results	21
How Data Is Presented	21
Means and Error Ranges	21
Rounding	22
Infrequent Material Types	23
Statewide Characterization Results.....	25
Vehicle Survey Data.....	25
Characterization Data	30
Compost/Mulch Quantities.....	88
Appendix A: Detailed Methodology.....	91
Overview	91
Definition of Regions, Waste Sectors, and Subsectors	91
Selection of, Scheduling, and Logistics at Solid Waste Facilities and Multi-Family Sites.....	95
Numbers of Samples	100
Obtaining and Sorting Waste Samples	102
Vehicle Surveys.....	104
Data Quality Control	108
Description of Calculations and Statistical Procedures Used.....	108

Appendix B: List and Definitions of Material Types.....	125
Introduction	125
Expanded and Standard List of Material Types	126
Definitions of Material Types (Expanded List).....	129
Material Type Examples.....	140
Appendix C: Forms Used in the Study	143
List of Forms Used	143
Appendix D: Expanded Statewide Waste Characterization Tables	165
Overall Disposed Waste Stream.....	165
Franchised Commercial Waste.....	168
Franchised Residential Waste.....	171
Single-Family Residential Waste	174
Multi-Family Residential Waste.....	177
Self-Hauled Waste.....	180
Commercial Self-Hauled Waste	183
Residential Self-Hauled Waste.....	186
Commercially Generated Disposed Waste	189
Residentially Generated Disposed Waste.....	192

Table of Tables

Table ES-1: Estimated Contribution of Each Sector to California’s Overall Disposed Waste Stream ..	4
Table ES-2: Ten Most Prevalent Material Types in California’s Overall Disposed Waste Stream	6
Table ES-3: Composition of California’s Overall Disposed Waste Stream by Material Type	7
Table 1: Numbers of Waste Samples Characterized, by Sector and Subsector, 2004 through 2014 ...	12
Table 2: Numbers of Waste Samples Characterized, by Sector and Subsector	19
Table 3: Vehicle Survey Responses, by Region and Season	20
Table 4: Estimated Contribution of Each Sector to California’s Overall Disposed Waste Stream	27
Table 5: Estimated Quantities of Construction Debris, by Sector	29
Table 6: Ten Most Prevalent Material Types in California’s Overall Disposed Waste Stream	31
Table 7: Composition of California’s Overall Disposed Waste Stream	33
Table 8: Franchised Commercial Samples Obtained, by Region and Season	35
Table 9: Ten Most Prevalent Material Types in Franchised Commercial Disposed Waste	37
Table 10: Composition of Franchised Commercial Disposed Waste	39
Table 11: Ten Most Prevalent Material Types in Franchised Residential Disposed Waste	43
Table 12: Composition of Franchised Residential Disposed Waste	45
Table 13: Single-Family Residential Samples Obtained, by Region and Season	47
Table 14: Ten Most Prevalent Material Types in Single-Family Residential Disposed Waste	49
Table 15: Composition of Single-Family Residential Disposed Waste	51
Table 16: Multi-Family Residential Samples Obtained, by Region and Season	53
Table 17: Ten Most Prevalent Material Types in Multi-Family Residential Disposed Waste	55
Table 18: Composition of Multi-Family Residential Disposed Waste	57
Table 19: Self-Hauled Samples Obtained by Region and Season	59
Table 20: Estimated Quantities of Construction Debris, by Self-Hauled Subsector	61
Table 21: Ten Most Prevalent Material Types in Overall Self-Hauled Disposed Waste	63
Table 22: Composition of Overall Self-Hauled Disposed Waste	65
Table 23: Commercial Self-Hauled Samples Obtained, by Region and Season	67
Table 24: Ten Most Prevalent Material Types in Commercial Self-Hauled Disposed Waste	69
Table 25: Composition of Commercial Self-Hauled Disposed Waste	71
Table 26: Residential Self-Hauled Samples Obtained, by Region and Season	73
Table 27: Ten Most Prevalent Material Types in Residential Self-Hauled Disposed Waste	75
Table 28: Composition of Residential Self-Hauled Disposed Waste	77
Table 29: Ten Most Prevalent Material Types in Franchised Commercial Plus Commercial Self-Hauled Disposed Waste	80
Table 30: Composition of Franchised Commercial Plus Commercial Self-Hauled Disposed Waste ..	82
Table 31: Ten Most Prevalent Material Types in Franchised Residential Plus Residential Self-Hauled Disposed Waste	85

Table 32: Composition of Franchised Residential Plus Residential Self-Hauled Disposed Waste.....	87
Table 33: Selected Compost/Mulch Material Types, Disposed Composition by Sector.....	89
Table 34: Selected Compost/Mulch Material Types, Disposed Quantities by Sector.....	90
Table 35: Counties in the Five Sampling Regions	93
Table 36: Participating Sampling Facilities	97
Table 37: Planned vs. Actual Numbers of Waste Samples	100
Table 38: Waste Samples Characterized During the Study.....	101
Table 39: Additional 16 Survey-Only Facilities.....	106
Table 40: Total Waste Disposal (Tons) in Each County and Region, 2013.....	114
Table 41: Regional Disposal at Surveyed Facilities.....	117
Table 42: Tons by Analysis Sector and Region	123
Table 43: Comparison Between the 2014 Standard List and the 2014 Expanded List	126
Table 44: Materials Organized by Recoverability Group	128
Table 45: Ten Most Prevalent Material Types in California’s Overall Disposed Waste Stream Using Expanded Material Types.....	165
Table 46: Composition of California’s Overall Disposed Waste Stream Using Expanded Material Types	166
Table 47: Ten Most Prevalent Material Types in Franchised Commercial Disposed Waste Using Expanded Material Types.....	168
Table 48: Composition of Franchised Commercial Disposed Waste Using Expanded Material Types	169
Table 49: Ten Most Prevalent Material Types in Franchised Residential Disposed Waste Using Expanded Material Types.....	171
Table 50: Composition of Franchised Residential Disposed Waste Using Expanded Material Types	172
Table 51: Ten Most Prevalent Material Types in Single-Family Residential Disposed Waste Using Expanded Material Types.....	174
Table 52: Composition of Single-Family Residential Disposed Waste Using Expanded Material Types	175
Table 53: Ten Most Prevalent Material Types in Multi-Family Residential Disposed Waste Using Expanded Material Types.....	177
Table 54: Composition of Multi-Family Residential Disposed Waste Using Expanded Material Types	178
Table 55: Ten Most Prevalent Material Types in Overall Self-Hauled Disposed Waste Using Expanded Material Types.....	180
Table 56: Composition of Overall Self-Hauled Disposed Waste Using Expanded Material Types ..	181
Table 57: Ten Most Prevalent Material Types in Commercial Self-Hauled Disposed Waste Using Expanded Material Types.....	183
Table 58: Composition of Commercial Self-Hauled Disposed Waste Using Expanded Material Types	184

Table 59: Ten Most Prevalent Material Types in Residential Self-Hauled Disposed Waste Using Expanded Material Types	186
Table 60: Composition of Residential Self-Hauled Disposed Waste Using Expanded Material Types	187
Table 61: Ten Most Prevalent Material Types in Franchised Commercial Plus Commercial Self-Hauled Disposed Waste Using Expanded Material Types	189
Table 62: Composition of Franchised Commercial Plus Commercial Self-Hauled Disposed Waste Using Expanded Material Types	190
Table 63: Ten Most Prevalent Material Types in Franchised Residential Plus Residential Self-Hauled Disposed Waste Using Expanded Material Types	192
Table 64: Composition of Franchised Residential Plus Residential Self-Hauled Disposed Waste Using Expanded Material Types	193

Table of Figures

Figure ES-1: Material Classes in California’s Overall Disposed Waste Stream.....	5
Figure ES-2: Material Classes in the Franchised Commercial Disposed Waste Stream.....	5
Figure ES-3: Material Classes in the Franchised Residential Disposed Waste Stream.....	5
Figure ES-4: Material Classes in the Self-Hauled Disposed Waste Stream.....	5
Figure 1: Regions Considered in the Study	14
Figure 2: Overview of Waste Disposal Sectors and Subsectors.....	15
Figure 3: Hand-Sorting a Sample	18
Figure 4. Surveying a Self-Hauled Vehicle.....	19
Figure 5: Overview of California’s Overall Disposed Waste Stream	47
Figure 6: Recoverability of California’s Overall Disposed Waste Stream.....	32
Figure 7: Overview of Franchised Commercial Disposed Waste	36
Figure 8: Recoverability of Franchised Commercial Disposed Waste.....	38
Figure 9: Overview of Franchised Residential Disposed Waste	42
Figure 10: Recoverability of Franchised Residential Disposed Waste	44
Figure 11: Overview of Single-Family Residential Disposed Waste.....	48
Figure 12: Recoverability of Single-Family Residential Disposed Waste	50
Figure 13: Overview of Multi-Family Residential Disposed Waste	54
Figure 14: Recoverability of Multi-Family Residential Disposed Waste	56
Figure 15: Overview of Overall Self-Hauled Disposed Waste	62
Figure 16: Recoverability of Overall Self-Hauled Disposed Waste.....	64
Figure 17: Overview of Commercial Self-Hauled Disposed Waste.....	68
Figure 18: Recoverability of Commercial Self-Hauled Disposed Waste.....	70
Figure 19: Overview of Residential Self-Hauled Disposed Waste	74
Figure 20: Recoverability of Residential Self-Hauled Disposed Waste.....	76
Figure 21: Overview of Franchised Commercial Plus Commercial Self-Hauled Disposed Waste.....	79
Figure 22: Recoverability of Franchised Commercial Plus Commercial Self-Hauled Disposed Waste	81
Figure 23: Overview of Franchised Residential Plus Residential Self-Hauled Disposed Waste	84
Figure 24: Recoverability of Franchised Residential Plus Residential Self-Hauled Disposed Waste	86
Figure 25: Regions Considered in the Study	92
Figure 26: Overview of Waste Disposal Sectors and Subsectors.....	94
Figure 27: Systematic Sampling Procedure for Incoming Loads.....	103
Figure 28: Sample to be Sorted	104
Figure 29: Sort Table and Tubs	104
Figure 30: Estimated Contribution of Each Sector to California’s Overall Disposed Waste Stream, 1995-2014.....	115
Figure 31: Contribution of the Commercial Sector to Disposal by Region, 2004–2014.....	116

Acknowledgments

This study would not have been possible without the cooperation and assistance of solid waste management companies, solid waste facilities, waste haulers, and apartment managers and owners throughout the state of California who generously agreed to participate in this effort.

Executive Summary

Introduction and Objectives

Through periodic studies, CalRecycle tracks California's ever-changing waste stream while gathering new information on materials of concern as they are identified. With up-to-date information on the types and amounts of materials disposed in the state's waste stream, CalRecycle can better determine where changes are needed to achieve California's 75 percent recycling goal. These data are essential for solid waste management planning, assessment of waste diversion activities, market development for recovered materials, and charting progress toward climate impact goals. Data generated from these studies are critical for several reasons:

- An accurate appraisal of recyclable materials in the disposed waste stream can help ensure that diversion goals are both reasonably set and effectively reached and that recyclable materials are being directed to their highest and best uses.
- Reducing the amount of bulky and biodegradable organic materials in the disposed waste stream is an effective way of reducing greenhouse gas emissions while extending the life of landfills. Characterization studies assess the amount of organics still being landfilled.
- The volume and type of household hazardous waste, electronic waste, and other types of special waste are constantly fluctuating with the changing list of goods on the market. The impact of these wastes on the natural environment is of constant concern. Staying abreast of these materials and current ways of handling them is of the utmost importance for a healthy California.

CalRecycle contracted with Cascadia Consulting Group to characterize and quantify the statewide disposed waste stream in 2014. This study followed standards and protocols similar to those used in the statewide waste characterization studies conducted in 2008 and 2004. The first statewide study was done in 1999 and used a different methodology. As with the 2004 and 2008 studies, the 2014 study estimates the quantity and composition of the commercial, residential, and self-hauled waste streams in California and aggregates this data to estimate the overall composition.

This report presents the findings of the 2014 Statewide Waste Characterization Study.

A concurrent study assessed the commercial waste and recycling streams through generator-based sampling. The results of that study are reported in an accompanying report titled "2014 Generator-Based Characterization of Commercial Sector Disposal and Diversion in California."

Study Methodology

A stratified random sampling methodology was used to sample waste from numerous subgroups (strata) to develop a waste composition profile for each stratum. Strata considered in this study included the geographical region, the waste sector (franchised residential, franchised commercial, or self-hauled), and the waste subsector (single-

family residential, multi-family residential, residential self-hauled, and commercial self-hauled). The strata were then “added together” in a way that reflects each stratum’s relative contribution to the overall waste stream, thus producing overall waste composition information.

The state was divided into five regions defined by similarities in demographic, climatic, geographic, and economic characteristics. Data regarding waste composition were gathered from 754 waste samples that our field crew sorted at 26 solid waste facilities (landfills and transfer stations) during four seasons. Whenever possible, a randomized process was used to select participating solid waste facilities, dates for fieldwork, vehicles carrying waste, and samples from loads. Approximately equal numbers of waste samples from each waste sector were obtained from each region of the state.

The sampled waste was sorted into 82 *material types*. However, the detailed composition tables in the main body of the report are presented using the 62 Standard Material Types from CalRecycle’s Uniform Waste Disposal Characterization Method. The expanded list of 82 *material types* used for sorting allows additional detail on materials of interest, yet is designed to be “folded up” into the standard list used for presenting results in this study. All *material types* were chosen and defined such that they can be compared to the *material types* used during California’s 2008 Statewide Waste Characterization Study. These materials are described in more detail in Appendix B: List and Definitions of Material Types. Tables containing waste composition data using the expanded 82 *material types* list are found in Appendix D: Expanded Statewide Waste Characterization Tables.

As part of the study, drivers at participating solid waste facilities were surveyed to determine the waste-generating sector and the net weight of each load, among other data. Results from these surveys were used to estimate the portion of California’s disposed waste derived from each waste sector and subsector. Surveys were conducted on the same days at the same sites that waste was sampled, with an additional 15 survey-only days at additional sites, split across the four study seasons. All vehicles, except for transfer trucks, bringing disposed waste to the study facilities were surveyed, for a total of 7,245 surveys completed over the study period.

Results

The data gathered during the sampling efforts were compiled and statistical analyses were performed to extrapolate the findings to statewide estimates. This report includes detailed findings for the following areas:

- Disposed waste composition and tonnage for the state’s overall waste stream and the commercial, residential, and self-hauled sectors.
- Disposed waste composition and tonnage for the state’s single-family residential waste, multi-family residential waste, commercial self-hauled waste, and residential self-hauled waste subsectors.

Special Note Regarding Sector Percentages

Sites participating in the composition study were selected at random from all eligible sites throughout the state. This site selection method ensured that the samples selected were representative of the materials disposed throughout the state. This method also should have ensured that vehicle survey data collected at each site accurately represented the proportion of waste disposed by each sector, subsector, and activity. However, during the data analysis, an unexpected anomaly was detected. Compared to previous studies, there was a steep increase in the portion of the waste stream attributable to the residential sector, with a comparable steep decrease in both the commercial and self-hauled sectors. A region-by-region analysis showed that the Southern Region had a massive change in its residential/commercial split when compared to previous studies. Since that region accounted for more than 60 percent of the state's disposed waste, even small changes there create substantial changes in the statewide results.

At the time of publication, CalRecycle staff are continuing to obtain more data from the Southern Region to determine if the sector percentages obtained are "real" or an artifact of changes in how waste is managed that affects our survey results. In the interim, we are publishing two sets of composition data for each of the sectors and subsectors. One set of data will reflect the use of the 2014 calculated sector percentages applied to 2014 waste composition data. The second set of data applies the sector percentages obtained in the 2008 Statewide Waste Characterization Study to the 2014 waste composition data. This provides a side-by-side comparison using the two different sector percentages. In reality, the true value may lie somewhere in between. The side-by-side data is presented for sector tonnages and detailed composition tables only. All other tables and figures show only the 2014 results as reported from field data observations, considered to be initial results. If CalRecycle staff obtain additional data that invalidate the sector splits calculated in the 2014 results, we will publish an addendum to this report.

A more in-depth explanation and analysis of this issue may be found in the section titled Special Note Regarding Vehicle Surveys and Quantifying Waste in Appendix A: Detailed Methodology of this report.

Findings

Table ES-1 depicts each sector's estimated contribution to the overall waste stream, showing results from using both 2014 vehicle surveys and 2008 vehicle surveys.

Figure ES-1 through Figure ES-4 present the material composition by **Material Class** for the overall waste stream and for each of the three studied waste sectors. Table ES-2 presents the 10 most prevalent *material types* in the overall disposed waste stream. Figure ES-1 through Figure ES-4 and Table ES-2 present results using 2014 sector percentages applied to 2014 composition results. Finally, Table ES-3 provides a detailed breakdown of the composition of the overall waste stream by *material type* showing both compositions and quantities using 2014 sector percentages and 2008 sector percentages applied to 2014 composition percentages.

Table ES-1: Estimated Contribution of Each Sector to California's Overall Disposed Waste Stream

Sector	Calculated Using 2014 Sector Percentages		Calculated Using 2008 Sector Percentages	
	Est. % of Disposed Waste	Est. Tons Disposed Statewide	Est. % of Disposed Waste	Est. Tons Disposed Statewide
Franchised Commercial*	38.6%	11,909,937	49.6%	15,301,492
Franchised Residential*	47.0%	14,516,212	30.0%	9,254,001
<i>Single-family residential</i>	35.4%	10,924,313	21.6%	6,662,188
<i>Multi-family residential</i>	11.6%	3,591,900	8.4%	2,591,814
Self-Hauled	14.4%	4,438,130	20.4%	6,308,785
<i>Commercial self-hauled</i>	11.3%	3,486,297	17.1%	5,285,747
<i>Residential self-hauled</i>	3.1%	951,833	3.3%	1,023,039
Totals	100.0%	30,864,279	100.0%	30,864,279

Numbers may not total exactly due to rounding. Source: 2014 vehicle survey findings and 2008 vehicle survey findings applied to individual facility records and CalRecycle Disposal Reporting System 2013 tonnage figures. See *Special Note Regarding Sector Percentages* on Page 3 for further explanation of sector percentage issues.

*Includes waste collected by both private and public entities that provide service to residential and business customers.

Figure ES-1: Material Classes in California's Overall Disposed Waste Stream

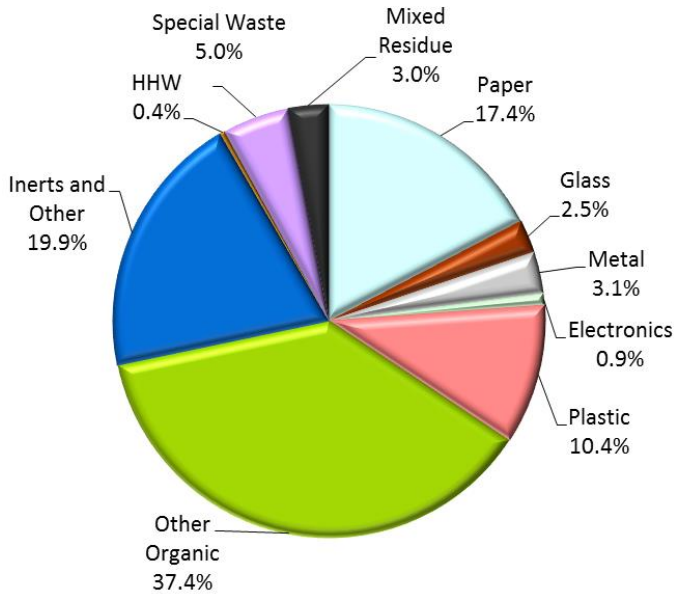

Figure ES-2: Material Classes in the Franchised Commercial Disposed Waste Stream

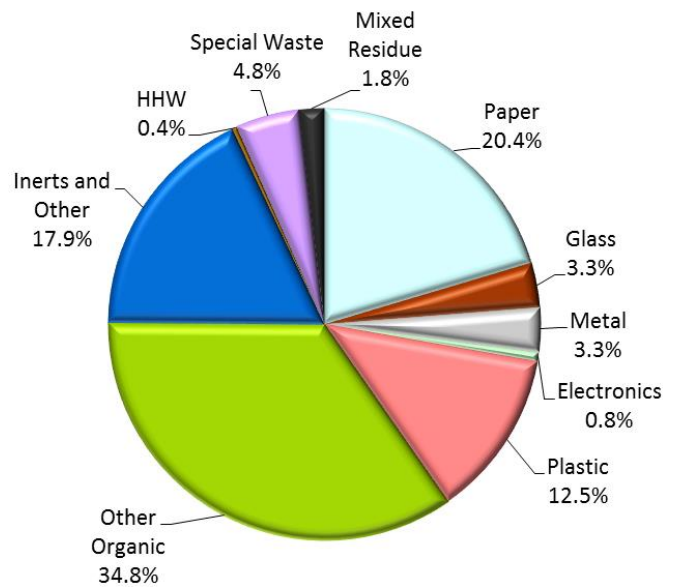

Figure ES-3: Material Classes in the Franchised Residential Disposed Waste Stream

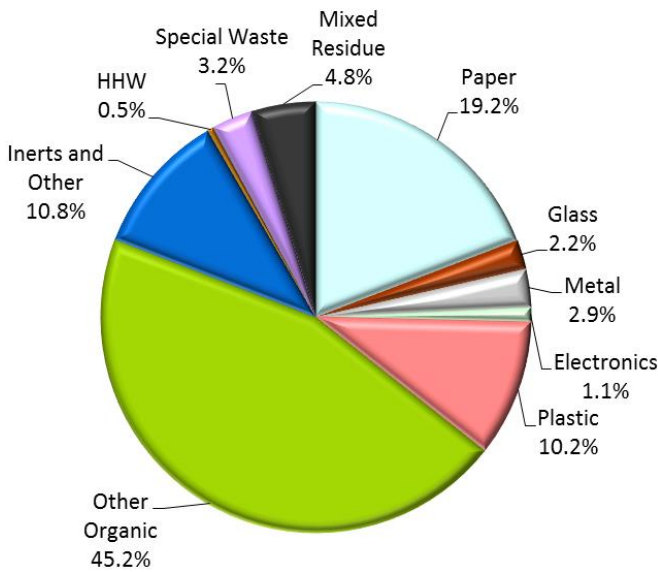
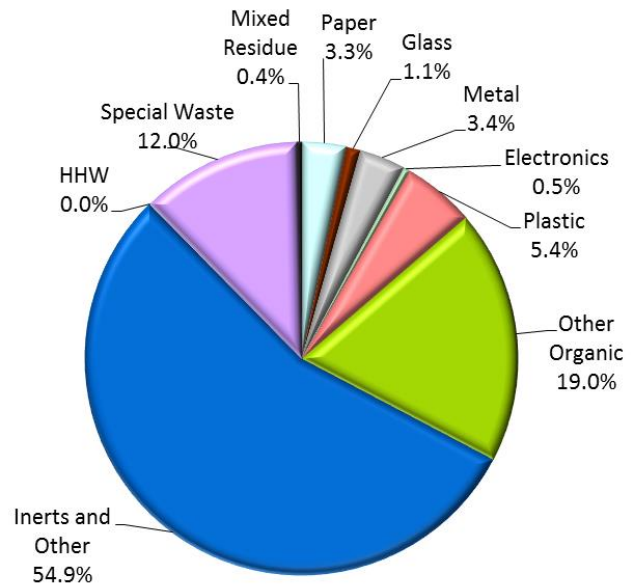

Figure ES-4: Material Classes in the Self-Hauled Disposed Waste Stream



Numbers may not total exactly due to rounding.

The above pie charts were constructed using sector percentage data obtained from the 2014 vehicle surveys applied to 2014 composition results. See *Special Note Regarding Sector Percentages* on Page 3 for a further explanation of the sector percentage issues. See Table ES-3 for a listing of *material types* in each **Material Class**.

Table ES-2: Ten Most Prevalent Material Types in California’s Overall Disposed Waste Stream

Material	Estimated Percent	Cumulative Percent	Estimated Tons
Food	18.1%	18.1%	5,591,179
Lumber	11.9%	30.0%	3,676,710
Remainder/Composite Paper	7.5%	37.6%	2,325,048
Bulky Items	4.4%	42.0%	1,365,340
Remainder/Composite Organic	4.3%	46.3%	1,323,465
Textiles	4.0%	50.3%	1,234,711
Other Miscellaneous Paper	3.9%	54.2%	1,215,919
Leaves and Grass	3.8%	58.0%	1,172,925
Uncoated Corrugated Cardboard	3.1%	61.1%	964,942
Prunings and Trimmings	3.1%	64.3%	962,262
Total	64.3%		19,832,501

The above table was constructed using sector percentage data obtained from the 2014 vehicle surveys applied to 2014 composition results. See *Special Note Regarding Sector Percentages* on Page 3 for a further explanation of the sector percentage issues. Any differences between cumulative percent figures and the sum of estimated percent figures are due to rounding. Note that the material type *remainder/composite paper* includes such items as waxed corrugated cardboard, aseptic packages, paper towels, and photographs. *Remainder/composite organic* includes leather items, cork, garden hoses, carpet padding, and diapers. See Appendix B: List and Definitions of Material Types for definitions of the different material types

Table ES-3: Composition of California's Overall Disposed Waste Stream by Material Type

Material	Est. Using 2014 Sector Percentages			Est. Using 2008 Sector Percentages		
	Estimated Percent	+ / -	Estimated Tons	Estimated Percent	+ / -	Estimated Tons
Paper	17.4%		5,367,734	16.8%		5,176,996
Uncoated Corrugated Cardboard	3.1%	0.6%	964,942	3.7%	0.8%	1,152,480
Paper Bags	0.2%	0.0%	70,627	0.2%	0.0%	62,259
Newspaper	1.2%	0.4%	372,966	0.9%	0.3%	285,517
White Ledger Paper	0.4%	0.1%	121,637	0.4%	0.2%	132,219
Other Office Paper	0.3%	0.1%	103,845	0.3%	0.1%	89,177
Magazines and Catalogs	0.6%	0.1%	178,166	0.5%	0.1%	158,407
Phone Books and Directories	0.0%	0.0%	14,583	0.0%	0.0%	13,590
Other Miscellaneous Paper	3.9%	0.4%	1,215,919	3.8%	0.5%	1,164,676
Remainder/Composite Paper	7.5%	0.6%	2,325,048	6.9%	0.6%	2,118,672
Glass	2.5%		764,162	2.5%		770,530
Clear Glass Bottles and Containers	0.9%	0.1%	263,439	0.7%	0.1%	225,563
Green Glass Bottles and Containers	0.2%	0.1%	71,382	0.2%	0.1%	57,935
Brown Glass Bottles and Containers	0.4%	0.1%	111,432	0.3%	0.1%	104,175
Other Glass Colored Bottles and Containers	0.0%	0.0%	12,185	0.0%	0.0%	11,843
Flat Glass	0.1%	0.1%	42,481	0.2%	0.2%	56,510
Remainder/Composite Glass	0.9%	1.0%	263,243	1.0%	1.3%	314,504
Metal	3.1%		957,027	3.1%		964,502
Tin/Steel Cans	0.7%	0.1%	204,449	0.6%	0.2%	186,422
Major Appliances	0.2%	0.2%	50,251	0.1%	0.1%	29,000
Used Oil Filters	0.0%	0.0%	1,255	0.0%	0.0%	1,098
Other Ferrous	0.8%	0.2%	248,593	0.9%	0.3%	267,932
Aluminum Cans	0.2%	0.0%	47,233	0.1%	0.0%	42,696
Other Non-Ferrous	0.5%	0.2%	157,478	0.6%	0.3%	181,009
Remainder/Composite Metal	0.8%	0.2%	247,768	0.8%	0.3%	256,344
Electronics	0.9%		273,878	0.7%		230,498
Brown Goods	0.3%	0.2%	84,415	0.2%	0.1%	75,142
Computer-related Electronics	0.1%	0.1%	45,648	0.1%	0.1%	41,339
Other Small Consumer Electronics	0.2%	0.1%	68,932	0.2%	0.1%	54,457
Video Display Devices	0.2%	0.1%	74,883	0.2%	0.1%	59,560
Plastic	10.4%		3,215,943	10.4%		3,203,542
PETE Containers	0.6%	0.1%	197,202	0.6%	0.1%	179,529
HDPE Containers	0.5%	0.1%	139,189	0.4%	0.1%	136,693
Miscellaneous Plastic Containers	0.6%	0.1%	173,738	0.5%	0.1%	165,343
Plastic Trash Bags	1.2%	0.1%	383,130	1.2%	0.2%	379,315
Plastic Grocery and Other Merchandise Bags	0.5%	0.1%	157,395	0.4%	0.0%	128,298
Non-Bag Commercial and Industrial Packaging Film	0.3%	0.1%	83,192	0.3%	0.1%	102,661
Film Products	0.2%	0.3%	73,394	0.4%	0.5%	118,895
Other Film	1.8%	0.2%	543,476	1.7%	0.2%	523,211
Durable Plastic Items	2.2%	0.5%	682,812	2.2%	0.5%	671,213
Remainder/Composite Plastic	2.5%	0.3%	782,415	2.6%	0.5%	798,384

Confidence intervals calculated at the 90% confidence level. Percentages for material types may not total 100% due to rounding.
 More detailed composition tables can be found in Appendix D: Expanded Statewide Waste Characterization Tables

The above table presents the 2014 sector percentages applied to the 2014 waste composition data and, for comparison, the sector percentages obtained in the 2008 Statewide Waste Characterization Study applied to the 2014 waste composition data. See *Special Note Regarding Sector Percentages* on Page 3 for a further explanation of the sector percentage issues.

Table ES-3 (continued): Composition of California's Overall Disposed Waste Stream by Material Type

Material	Est. Using 2014 Sector Percentages			Est. Using 2008 Sector Percentages		
	Estimated Percent	+ / -	Estimated Tons	Estimated Percent	+ / -	Estimated Tons
Other Organic	37.4%		11,558,054	34.4%		10,614,389
Food	18.1%	1.6%	5,591,179	16.5%	1.8%	5,083,364
Leaves and Grass	3.8%	1.2%	1,172,925	3.4%	1.3%	1,048,621
Prunings and Trimmings	3.1%	1.0%	962,262	2.8%	1.0%	868,512
Branches and Stumps	1.7%	0.9%	528,493	1.8%	1.0%	544,872
Manures	0.6%	0.6%	174,808	0.7%	0.7%	214,875
Textiles	4.0%	0.7%	1,234,711	3.6%	0.7%	1,114,224
Carpet	1.8%	0.6%	570,212	2.0%	0.7%	605,950
Remainder/Composite Organic	4.3%	0.5%	1,323,465	3.7%	0.5%	1,133,971
Inerts and Other	19.9%		6,132,838	23.5%		7,265,537
Concrete	1.2%	0.4%	373,185	1.3%	0.5%	415,287
Asphalt Paving	0.2%	0.3%	70,269	0.4%	0.7%	130,364
Asphalt Roofing	0.7%	0.4%	223,236	0.8%	0.6%	251,150
Lumber	11.9%	1.8%	3,676,710	13.7%	2.0%	4,229,070
Gypsum Board	1.1%	0.4%	327,002	1.3%	0.5%	401,684
Rock, Soil and Fines	2.4%	0.7%	750,357	2.9%	1.0%	896,129
Remainder/Composite Inerts and Other	2.3%	0.7%	712,079	3.1%	1.1%	941,853
Household Hazardous Waste (HHW)	0.4%		109,568	0.3%		78,461
Paint	0.2%	0.1%	48,951	0.1%	0.1%	31,414
Vehicle & Equipment Fluids	0.0%	0.0%	219	0.0%	0.0%	88
Used Oil	0.0%	0.0%	1,410	0.0%	0.0%	939
Batteries	0.0%	0.0%	11,887	0.0%	0.0%	10,894
Remainder/Composite Household Hazardous	0.2%	0.1%	47,102	0.1%	0.1%	35,125
Special Waste	5.0%		1,558,079	5.8%		1,803,511
Ash	0.1%	0.0%	16,138	0.1%	0.1%	17,409
Treated Medical Waste	0.1%	0.2%	34,909	0.1%	0.1%	30,645
Bulky Items	4.4%	1.3%	1,365,340	5.1%	1.4%	1,574,149
Tires	0.1%	0.1%	39,393	0.1%	0.1%	39,308
Remainder/Composite Special Waste	0.3%	0.3%	102,299	0.5%	0.4%	142,000
Mixed Residue	3.0%		926,996	2.5%		756,314
Totals	100.0%		30,864,279	100.0%		30,864,279
Sample Count	754			754		

Confidence intervals calculated at the 90% confidence level. Percentages for material types may not total 100% due to rounding.

More detailed composition tables can be found in Appendix D: Expanded Statewide Waste Characterization Tables

The above table presents the 2014 sector percentages applied to the 2014 waste composition data and, for comparison, the sector percentages obtained in the 2008 Statewide Waste Characterization Study applied to the 2014 waste composition data. See *Special Note Regarding Sector Percentages* on Page 3 for a further explanation of the sector percentage issues.

Key Findings

- Based on 2014 sector percentages, the franchised residential sector (single-family plus multi-family) generates 47 percent and the franchised commercial sector generates 39 percent of the disposed waste stream statewide. The self-hauled sector generates the remaining 14 percent.
- Organic materials such as food scraps, yard waste, and lumber continue to be a large part of the waste disposed in California landfills. The largest **Material Class** is **Other Organic**, which accounts for more than one-third of the statewide disposed waste stream (37 percent using 2014 sector percentages and 34 percent using 2008 sector percentages). This class of materials includes food waste, yard waste, carpet, and textiles. *Food* is the most prevalent *material type* in the entire disposed waste stream (more than 16 percent using either 2014 or 2008 sector percentages).
- The next largest **Material Class** is **Inerts and Other** at almost 20 percent of all disposal using 2014 sector percentages and 24 percent using 2008 sector percentages. More than half of this class is *lumber* (the second-largest *material type* disposed overall); other material types in this class include *concrete*, *gypsum board*, and *rock soil and fines*.
- Taken together, materials suitable for composting, mulch, anaerobic digestion, or other organics recovery strategies account for about 40 percent of California's disposed waste stream. This includes food, vegetative materials, clean wood materials, and compostable paper. Table 33 and Table 34 summarize the sources of these materials.
- **Paper** is the third-largest **Material Class**, at approximately 17 percent of disposed waste using either 2014 or 2008 sector percentages. *Other miscellaneous paper* is the most prevalent recyclable material, using either 2014 or 2008 sector percentages.

Comparison with 2008 Statewide Waste Characterization Study

The following comparisons apply to the results estimated using the 2014 sector percentages applied to the 2014 composition data.

- The 2014 study was conducted during an extraordinary time for California: The state was slowly recovering from the most significant economic downturn in decades and is also experiencing one of the worst droughts in its history.
- The proportions of the waste stream contributed by the franchised commercial and franchised residential sectors have changed noticeably. Franchised commercial disposal decreased from 50 percent to 39 percent while franchised residential disposal increased from 30 percent to 47 percent.

- The largest change in the overall waste stream composition was a decrease from 29 percent to 20 percent in the **Inerts and Other** class. Disposal of nearly every **Inerts and Other** material decreased between the two studies.
- In the franchised commercial sector, disposal of **Paper, Metal, and Inerts and Other** each decreased. **Inerts and Other** decreased by approximately 10 percentage points.
- Overall per capita disposal decreased from 1.06 to 0.81 tons per person per year (calculated by dividing tons of all disposed municipal solid waste by total population). Residential per capita disposal increased from 0.32 to 0.38 tons per resident per year (calculated by dividing all disposed franchised residential waste by total population).

Introduction and Overview

Through periodic studies, CalRecycle tracks California's ever-changing waste stream while gathering new information on materials of concern as they are identified. With up-to-date information on the types and amounts of materials disposed in the state's waste stream, CalRecycle can better determine where changes are needed to achieve California's 75 percent recycling goal. These data are essential for solid waste planning, assessment of waste diversion activities, market development for recovered materials, and charting progress toward climate impact goals. Data generated from these studies are critical for several reasons:

- An accurate appraisal of recyclable materials in the disposed waste stream can help ensure that diversion goals are both reasonably set and effectively reached and that recyclable materials are being directed to their highest and best uses.
- Reducing the amount of bulky and biodegradable organic materials from the disposed waste stream is an effective way of reducing greenhouse gas emissions while extending the life of landfills. Characterization studies assess amounts of organics still being landfilled.
- Household hazardous waste, electronic waste, and other types of special waste are constantly fluctuating with the changing list of goods on the market. The impact of these wastes on the natural environment is of constant concern. Staying abreast of these materials and current ways of handling them is of the utmost importance for a healthy California.

CalRecycle contracted with Cascadia Consulting Group to characterize and quantify the current statewide disposed waste stream in 2014. This study followed similar standards and protocols to those used in the statewide waste characterization studies conducted in 2008 and 2004. The first statewide study was done in 1999 and used a different methodology. This report presents the findings of the 2014 Statewide Waste Characterization Study.

Note: A concurrent study assessed the commercial waste and recycling streams through generator-based sampling. The results of that study are detailed in an accompanying report titled "2014 Statewide Commercial Waste Characterization Study."

Relation to Previous Studies

Cascadia previously conducted statewide waste characterization studies in 1999, 2004, 2006, and 2008. The 1999 study developed a comprehensive set of baseline estimates of the quantity and composition of disposed municipal solid waste statewide, and it included a detailed examination of disposed waste for individual industry groups within the commercial sector. The 2004 and 2008 studies, like the present study, also developed comprehensive estimates of the statewide disposed waste stream, but without the more detailed examination of individual industry groups. The 2006 study examined four specific portions of the waste stream in depth and focused on examining

disposal and recycling practices of certain industry groups even more closely. Thus, the findings of the present study are most directly comparable to those of the 2004 and 2008 statewide studies and are also comparable to parts of the 1999 statewide study. The concurrent study on the commercial waste stream is comparable to the 2006 study and parts of the 1999 study.

The primary objectives of the 2004, 2008, and 2014 studies were to characterize and quantify the residential, commercial, and self-hauled sectors of the disposed waste stream at the statewide level. The 2004 study characterized a total of 550 samples, while the 2008 study increased the number of samples characterized to 751. The 2014 study characterized a similar number of samples to the 2008 study: a total of 754 samples. Table 1 provides the sample allocations by sector and subsector for these study years.

Table 1: Numbers of Waste Samples Characterized, by Sector and Subsector, 2004 through 2014

Sector	Number of Samples: 2004	Number of Samples: 2008	Number of Samples: 2014
Franchised Commercial	200	250	251
Franchised Residential	150	251	253
<i>Single-family residential</i>	110	201	201
<i>Multi-family residential</i>	40	50	52
Self-Hauled	200	250	250
<i>Commercial self-hauled</i>	133	139	134
<i>Residential self-hauled</i>	67	111	116
Total	550	751	754

To facilitate comparisons among the 2004, 2008, and 2014 studies, every effort has been made to ensure consistency in study methodology and presentation of findings from 2004, 2008, and 2014.

Objectives and General Methodology of the 2014 Study

The primary objectives of this project were to characterize and quantify the franchised residential, franchised commercial, and self-hauled disposed waste at the statewide level. Part of this effort involved examining important subsectors of the disposed waste stream, including single-family residential and multi-family residential waste, residential self-hauled waste, and commercial self-hauled waste.

Waste was sampled using a stratified random sampling methodology. Waste was sampled from numerous subgroups (strata such as geographical region and waste sector) to develop a waste composition profile for each stratum. The strata were then combined using a methodology that reflects each stratum’s relative contribution to the overall waste stream, thus producing overall waste composition information.

The remainder of this section outlines the planning and data collection strategies implemented during this study. The planning phase included:

- Identifying the regions of the state to be visited;
- Defining the waste sectors to be examined during the study;
- Recruiting and scheduling solid waste disposal sites statewide for surveying and sampling; and
- Selecting the *material types* to be examined throughout the study.

The data collection phase included:

- Determining the composition of the waste stream through sampling and sorting; and
- Quantifying the waste stream through vehicle surveys.

Identifying Regions

For the purposes of this study, the state was divided into five regions, as shown in Figure 1. Counties were grouped into regions based on similarities in demographics, climate, geography, and economic characteristics. The assignment of individual counties to regions is identical to the approach used in the 2008 Statewide Waste Characterization Study and is described in more detail in Appendix A: Detailed Methodology. In general, the regions can be characterized as follows:

- **Coastal** – includes the counties on or near the coast that are not in either the Bay Area or Southern Regions. The Coastal Region is more populated than the rural Mountain Region and has a large agricultural component similar to the Central Valley.
- **Bay Area** – includes the counties in the San Francisco Bay Area, which are more metropolitan counties with a strong industrial component in the economy.
- **Southern** – includes counties that are strongly industrial with large populations and some agricultural influences.
- **Mountain** – includes counties that are primarily rural, with strong agricultural economies, low population density, and a low industrial base.
- **Central Valley** – includes counties between the Sierra Nevada Mountains and the Coast Range that have a major agricultural base with important population centers and some manufacturing.

Figure 1: Regions Considered in the Study

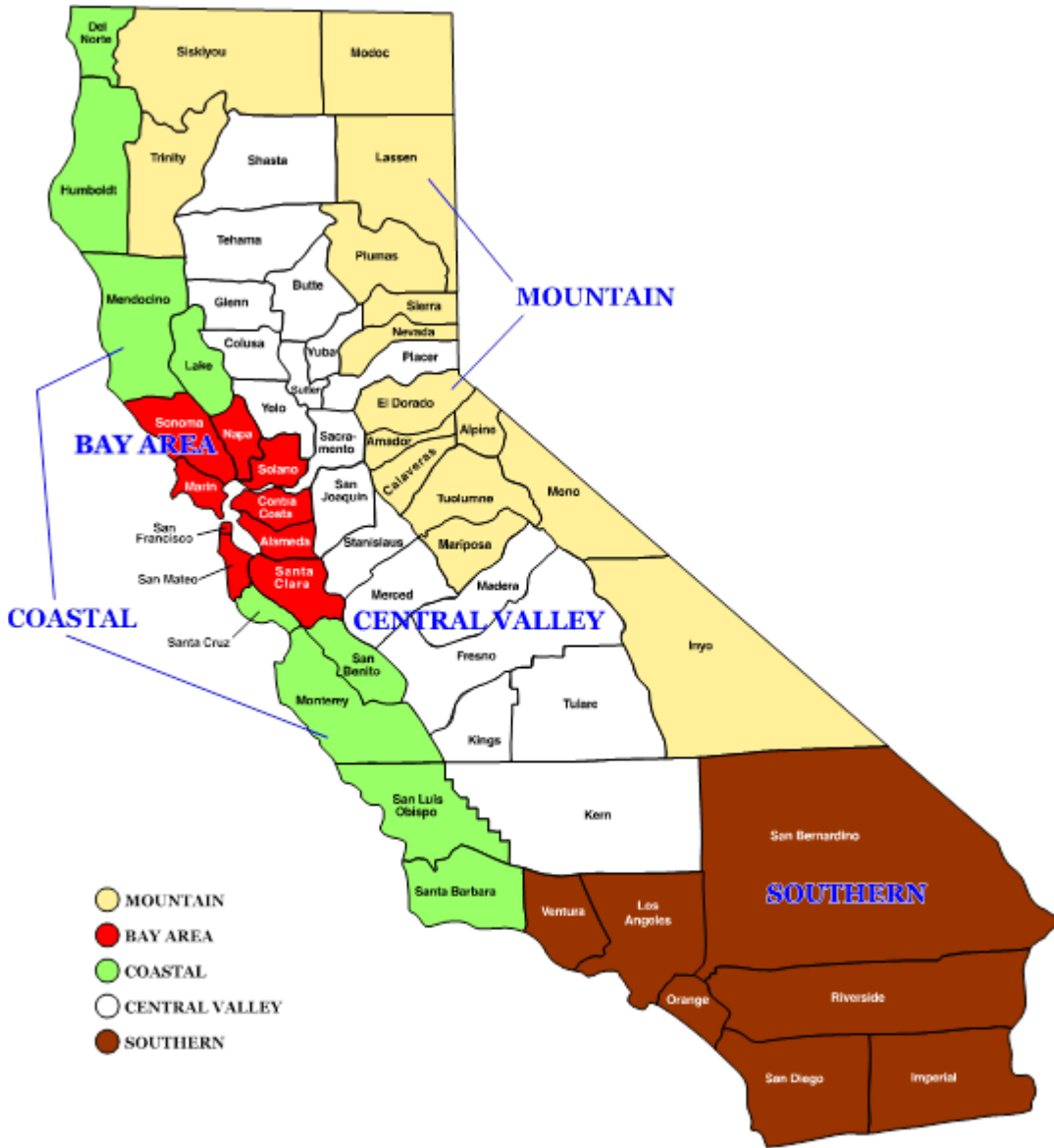

Defining Waste Sectors

In each of the five regions, waste was characterized for the three sectors and four subsectors as shown in Figure 2 below.

Figure 2: Overview of Waste Disposal Sectors and Subsectors

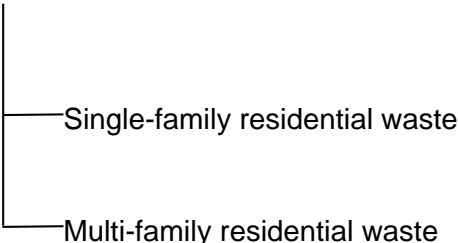
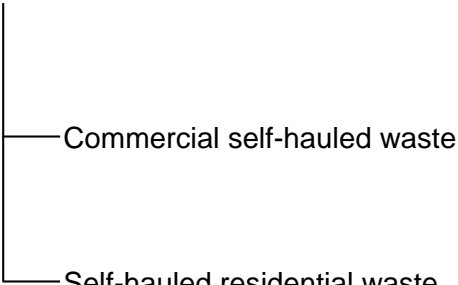
Sector Subsector	Description
Franchised Commercial Waste	Waste disposed by businesses, industries (e.g., factories, farms), institutions, and public areas (e.g., roads, parks) that is collected and transported by contracted or franchised waste haulers, both private and public (municipal).
Franchised Residential Waste 	Waste disposed by households that is collected and transported by contracted or franchised waste haulers, both private and public (municipal). Waste that is collected from either single-family residences or buildings that include no more than four living units. Waste that is collected from multi-unit buildings with greater than four living units.
Self-Hauled Waste 	Waste hauled by individuals, businesses, or government agencies that haul their own garbage; includes waste delivered by anyone other than a contracted, franchised, or municipal hauler. Waste that is hauled to a disposal site by a commercial enterprise (e.g., landscaper, contractor) even if waste is from residential dwellings. Waste that is hauled to a disposal site by a resident from his or her home.

Scheduling Sites

Once the study regions and sectors were defined, solid waste facilities in each region were randomly selected for sampling and surveying from a comprehensive list of landfills and transfer stations throughout the state. Potential sites were eliminated from the list if they did not meet certain minimum criteria, as follows:

1. The site had to accept waste destined for final disposal. For a landfill, this would mean waste that is to be buried; for a transfer station, it refers to waste that is not subjected to extensive mechanical separation or diversion techniques.
2. The site had to accept waste from all three waste sectors (franchised commercial, franchised residential, and self-hauled) in quantities that would allow a predetermined sampling quota to be met.
3. The site had to grant permission to perform sampling and sorting as well as provide a safe and logistically sensible space in which to work.
4. The site had to receive an average of at least 100 tons of incoming disposed waste per day.¹

The project team recruited five facilities in each region from the list of facilities eligible to participate in the study, for a total of 25 facilities. During each season, the field team visited and worked at 12 or 13 facilities (two to three per region). Through all four seasons, most of the facilities were visited twice, with visits to an individual facility staggered by approximately six months. Small rural facilities were usually visited for two days for each sorting event to ensure that adequate numbers of samples and gate surveys were obtained. During the course of the study, one of the winter season facilities had to be replaced for the summer season due to logistical difficulties, so a total of 50 sampling visits were made to 26 facilities. Appendix A: Detailed Methodology contains a list of all facilities visited for sampling. The sampling dates were as follows:

- Winter: January–February 2014
- Spring: April 2014
- Summer: July 2014
- Fall: October 2014

Appendix A: Detailed Methodology contains a thorough description of the facility selection and screening procedures.

¹ This requirement was waived for the Mountain region as few, if any, of the facilities in that region average 100 tons per day.

Selecting Material Types

Waste samples were sorted and characterized according to 82 *material types*, as described in Appendix B: List and Definitions of Material Types. The 82 *material types* are organized into 10 **Material Classes** as follows:

- 12 types of **Paper**
- 10 types of **Glass**
- 9 types of **Metal**
- 5 types of **Electronics**
- 15 types of **Plastic**
- 8 types of **Other Organic** waste
- 10 types of **Inerts and Other** waste
- 7 types of **Household Hazardous Waste (HHW)**
- 5 types of **Special Waste**
- 1 type of **Mixed Residue**.

Fewer *material types* were characterized in this study than in 2008, when 85 *material types* were characterized. Notable changes include the following:

- The number of **Paper** materials increased from 11 to 12, to better quantify compostable paper and aseptic packaging.
- The number of **Glass** materials increased from six to 10 to include an expanded list of California Redemption Value (CRV) and Non-CRV material types.
- The number of **Metal** materials increased from seven to nine, to include an expanded list of CRV and Non-CRV material types.
- The number of **Plastic** materials decreased from 17 to 15, combining plastic material types for water bottles, other types of packaging, and buckets and adding beverage and food pouches as a material type. CRV and non-CRV material types were also added.
- The number of **Inerts and Other** materials decreased from 15 to 10, combining roofing and gypsum board material types.
- The number of **Household Hazardous Waste** materials decreased from nine to seven.

- The number of **Special Waste** materials decreased from six to five, consolidating two tire *material types* into one since the detail was no longer needed.

These changes reflect the changes in data needs as new *material types* come into focus, but maintain consistency with past studies so that data can be compared over time.

Though samples were sorted into 82 *material types*, composition results are presented in the main body of this report according to the CalRecycle's 62 item Standard List of Material Types for Waste Sorting. The expanded list provides more detail and helps direct CalRecycle's waste reduction and diversion efforts. Detailed composition tables are included in Appendix D: Expanded Statewide Waste Characterization Tables. All changes made to the 2014 materials list allow comparisons to be made between the lists used in the 1999, 2004, and 2008 studies. Appendix B: List and Definitions of Material Types contains both the condensed and expanded material lists and definitions for all materials.

Determining the Composition of the Waste Stream

Samples of disposed waste from the franchised commercial, franchised single-family residential, and self-hauled sectors were captured at selected solid waste facilities (landfills or transfer stations) in each region and subjected to a hand-sorting separation process. Since multi-family waste is often collected with commercial waste, samples from the multi-family residential sector were collected from dumpsters at apartment buildings and complexes rather than at solid waste facilities in order to get pure samples. This allowed for more detailed analysis of the multi-family waste stream.

The sampling and sorting process produced data on the amount of each material in each sample. This data was then aggregated and subjected to statistical analysis to assess the composition (the relative percentage of each material) of each waste sector, and ultimately the entire waste stream. Samples associated with each waste sector and subsector were apportioned equally among facilities and regions.

Figure 3: Hand-Sorting a Sample

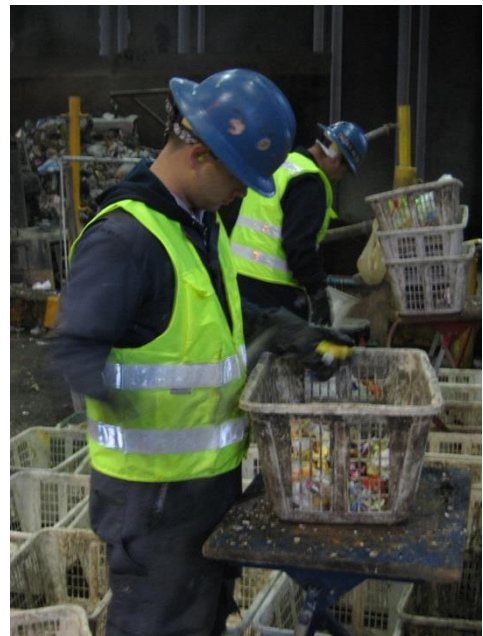

Table 2 shows the number of samples that were collected for each sector.

Table 2: Numbers of Waste Samples Characterized, by Sector and Subsector

Sector	Number of Samples
Franchised Commercial	251
Franchised Residential	253
<i>Single-family residential</i>	201
<i>Multi-family residential</i>	52
Self-Hauled	250
<i>Commercial self-hauled</i>	134
<i>Residential self-hauled</i>	116
Total	754

See Appendix A: Detailed Methodology for a detailed account of planned and actual waste samples and Table 38 for the distribution of samples among facilities. Generally, samples were distributed evenly across seasons and regions.

Quantifying the Waste Stream

To determine how many tons of disposed waste were associated with each of the waste sectors and subsectors, drivers were surveyed concurrently with sampling and sorting activities at participating facilities. In addition, the surveys included questions to identify loads from construction and demolition (C&D) activities and classify them as coming from new construction, remodeling, demolition, roofing, or other construction. Loads coming from landscaping activities by professional landscapers were also identified.

Vehicle surveys were conducted on each sampling day, as well as for an additional 15 days, at sites selected and distributed across the five regions. An extra day of surveying was added for each sampling event at several small rural sites since vehicle traffic is typically very light at these sites. Over the course of the study, 7,245 vehicle surveys were completed.

Figure 4. Surveying a Self-Hauled Vehicle



Table 3 shows the number of vehicle surveys completed by region and by season. Appendix A: Detailed Methodology includes a list of survey-only facilities. Copies of the survey forms are included in Appendix C: Forms Used in the Study.

Table 3: Vehicle Survey Responses, by Region and Season

Season	Bay Area	Coastal	Mountain	Southern	Valley	Totals
Winter 2014	453	239	342	172	412	1,618
Spring 2014	737	296	249	752	403	2,437
Summer 2014	431	134	380	343	350	1,638
Fall 2014	225	258	423	426	220	1,552
Totals	1,846	927	1,394	1,693	1,385	7,245

In conjunction with daily transaction reports and annual tonnage reports from facilities, the survey data were used to estimate the fraction of the overall waste stream disposed from each of the waste sectors, subsectors, and activities at each participating facility. In addition to the sites with completed vehicle surveys, one facility in the Coastal Region provided transaction records with enough detail to be included in the waste quantification calculations even though the site was not visited by the field crew. CalRecycle provided annual disposed tonnage figures, by region and statewide, which allowed these estimated percentages to be converted into annual tonnages for each sector, subsector, and activity at the regional and statewide levels. Appendix A: Detailed Methodology describes how this information was then used to estimate the relative magnitude of each part of the disposed waste stream on a regional basis and statewide.

Interpreting the Results

How Data Is Presented

For the overall disposed waste stream, and for each waste sector and subsector, data are presented in four ways:

- First, an overview of waste composition by broad **Material Class** is presented in both pie chart and tabular formats.
- Second, the 10 most prevalent individual *material types* by weight are shown in a table.
- Third, a pie chart presents the materials by five **Recoverability Groups**. The recoverability pie chart is based on the expanded material list, which breaks out materials into more detail. The list of which materials belong to which group can be found in Appendix B: List and Definitions of Material Types. The Recoverability Groups are:
 1. **Curbside Recyclables**: includes materials accepted in typical curbside recycling programs, based on research conducted on California jurisdictions.
 2. **Other Recyclables**: includes materials that can be recycled through other recycling programs, typically at drop-off locations.
 3. **Recoverable Inerts**: includes inert construction debris that is recoverable at most C&D debris processing facilities.
 4. **Compost/Mulch**: includes materials frequently accepted as feedstocks for commercial scale composting programs or for processing into landscaping mulch at processing facilities.
 5. **Disposed**: includes all other materials.
- Finally, a detailed table lists the full composition and quantity results for the 62 *standard material types*. Refer to Appendix B: List and Definitions of Material Types for a detailed list of material definitions used in the study. Tables showing results for composition by the 82 detailed material types can be found in Appendix D: Expanded Statewide Waste Characterization Tables.

Means and Error Ranges

The data from the sorting process were treated with a statistical procedure that provided two kinds of information for each of the *material types*:

- The percent-by-weight estimated composition of waste represented by the samples examined in the study; and
- The confidence interval for the composition estimates.

All confidence intervals were calculated at the 90 percent confidence level. The equations used in these calculations appear in the Description of Calculations and Statistical Procedures Used section of Appendix A: Detailed Methodology.

The example below illustrates how the results can be interpreted. In this example, the best estimate of the amount of *leaves and grass* present in the universe of waste sampled is 3.8 percent. The figure 0.7 percent reflects the precision of the estimate. When calculations are performed at the 90 percent confidence level, we are 90 percent certain that the true amount of *leaves and grass* is between 3.8 percent plus 0.7 percent and 3.8 percent minus 0.7 percent. In other words, we are 90 percent certain that the true mean lies between 4.5 percent and 3.1 percent.

Leaves and grass	3.8%	0.7%

Rounding

When interpreting the results presented in the tables and figures in this report, it is important to consider the **effect of rounding**.

To keep the waste composition tables and figures readable, estimated tonnages are rounded to the nearest ton, and estimated percentages are rounded to the nearest tenth of a percent. Due to this rounding, the **tonnages** presented in the report, when added together, may not exactly match the subtotals and totals shown. Similarly, the **percentages**, when added together, may not exactly match the subtotals or totals shown. Percentages less than 0.05 percent are shown as 0.0 percent.

It is important to recognize that the quantities presented in the tables were calculated using the unrounded percentages. Therefore, using the rounded percentages shown in the tables to calculate quantities will yield quantities that are different than those shown in the report.

For example, the rounded percentage for *lumber* using 2014 sector percentages in Table 7 is shown as 11.9 percent, but the unrounded number used in calculations was 11.9125075821563 percent. If the rounded percentage for *lumber* in Table 7 were used to calculate the tonnage, it would yield the following: 11.9 percent x 30,864,279 (the total tonnage) = 3,672,849 tons. However, if the more precise percentage for this material is used, it yields the following: 11.9125075821563 percent multiplied by 30,864,279.19 (the total tonnage) = 3676709.59868664 tons, or 3,677,710 tons when rounded to the nearest ton. Using unrounded numbers instead of rounded numbers in the calculations results in a difference of more than 4,800 tons. The more precise tonnage of 3,677,710 is shown in the table.

All confidence intervals were derived using a 90 percent confidence level, meaning that there is a 90 percent certainty that the actual composition is within the calculated range. In charts throughout this report, the values graphed represent the mean component percentage, not the range.

Infrequent Material Types

Composition estimates for certain materials have a higher degree of uncertainty for two main reasons:

- The materials are infrequently disposed, and, consequently, appear infrequently in samples. Examples of such materials include *paint*, *tires*, and *ash*. Because the composition results are based on few instances of these materials, the results are less certain, as shown by the relatively large confidence intervals.
- The quantity of material is highly variable between samples. *Treated medical waste*, for example, usually isn't found in any sample. When it is found, there is usually a large quantity of it (because the sample was generated at a hospital or other treatment facility). This variability also increases the confidence intervals.

As an example, using 2014 sector percentages, *remainder/composite household hazardous* is estimated to comprise 0.2 percent of the overall disposed stream with a 0.1 percent confidence interval. In other words, *remainder/composite household hazardous* may be as much as 0.3 percent or as little as 0.1 percent of the waste stream, 50 percent more or less than the best estimate (0.2 percent). Small, lightweight materials that appear frequently in samples also make up a small percentage of the overall composition. These frequently found materials, in contrast, have smaller relative confidence intervals. An example is *PETE plastic containers*, which comprise a small percentage of the overall waste stream (0.6 percent) and have a relatively small confidence interval (0.1 percent).

Statewide Characterization Results

This section presents vehicle survey results for statewide tonnages by sector and detailed characterization results for the overall disposed waste stream as well as for the franchised commercial, franchised residential, and self-hauled waste sectors and corresponding subsectors included in the study. Also, tables are included for the combined commercial waste (franchised commercial and commercial self-hauled combined), combined residential waste (franchised residential and residential self-hauled combined), and compost/mulch material types only from all sectors.

Vehicle Survey Data

Disposed Waste Quantities from Each Sector

Vehicle surveys were used to apportion tons between the strata included in the study. The facilities used for composition sampling and the accompanying vehicle surveys were selected randomly in order to be comparable to past studies. Then, for each region, an additional three facilities were selected from a pool of the largest remaining facilities in the region. These large facilities were surveyed once during the study. Vehicle survey data collected during the study were grouped and then analyzed to estimate statewide proportions of waste from each sector. A detailed explanation of the calculations used to estimate the statewide tonnage is included in the Quantifying Disposed Waste section of Appendix A: Detailed Methodology.

Franchised commercial and franchised residential waste includes all waste collected and transported to solid waste sites by contracted or franchised haulers, both private and public (municipal), from commercial or residential sources. Self-hauled waste includes both commercial and residential wastes that are hauled by anyone other than a contracted or franchised hauler (e.g., an individual homeowner, a construction company, a landscaper). For the purposes of this study, commercial self-hauled loads were those hauled by a commercial enterprise (e.g., contractor, landscaper) even if the source of the waste was a residential dwelling. Residential self-hauled loads were those loads transported by a resident from their home to the solid waste site.

Special Note Regarding Sector Percentages

Sites participating in the composition study were selected at random from all eligible sites throughout the state. This site selection method ensured that the samples selected were representative of the materials disposed throughout the state. This method also should have ensured that vehicle survey data collected at each site accurately represented the proportion of waste disposed by each sector, subsector, and activity. However, during the data analysis, an unexpected anomaly was detected. Compared to previous studies, there was a steep increase in the portion of the waste stream attributable to the residential sector, with a comparable steep decrease in both the commercial and self-hauled sectors. A region-by-region analysis showed that the Southern Region had a massive change in its residential/commercial split when compared to previous studies. Since that region accounted for more than 60 percent of

the state's disposed waste, even small changes there create substantial changes in the statewide results.

At the time of publication, CalRecycle staff are continuing to obtain more data from the Southern Region to determine if the sector percentages obtained are "real" or an artifact of changes in how waste is managed that affects our survey results. In the interim, we are publishing two sets of composition data for each of the sectors and subsectors. One set of data will reflect the use of the 2014 calculated sector percentages applied to 2014 waste composition data. The second set of data applies the sector percentages obtained in the 2008 Statewide Waste Characterization Study to the 2014 waste composition data. This provides a side-by-side comparison using the two different sector percentages. In reality, the true value may lie somewhere in between. The side-by-side data is presented for sector tonnages and detailed composition tables only. All other tables and figures show only the 2014 results as reported from field data observations, considered to be initial results. If CalRecycle staff obtain additional data that invalidate the sector splits calculated in the 2014 results, we will publish an addendum to this report.

A more in-depth explanation and analysis of this issue may be found in the section titled Special Note Regarding Vehicle Surveys and Quantifying Waste in Appendix A: Detailed Methodology of this report.

Findings

Based on the 2014 estimated sector percentages, franchised-hauled single-family and multi-family residential waste together account for 47 percent of the state's waste stream, and franchised commercial waste accounts for 39 percent of the state's waste stream. Overall, the per capita disposal rate for the state was approximately 0.81 tons per person per year in 2013. The per-capita disposal rates include all waste disposed at landfills, including that from industrial, institutional, and construction and demolition sources. Other states and federal agencies may define municipal solid waste differently from California. Based on the 2014 estimated sector percentages, the per capita disposal rate for franchised residential waste (single-family and multi-family) was approximately 0.38 tons per person per year. The average per occupied unit disposal rate for the multi-family subsector was 1.05 tons per unit per year.

Table 4 depicts each sector's estimated contribution to the overall waste stream, showing results from using both 2014 vehicle surveys and from 2008 vehicle surveys.

Table 4: Estimated Contribution of Each Sector to California’s Overall Disposed Waste Stream

Sector	Calculated Using 2014 Sector Percentages		Calculated Using 2008 Sector Percentages	
	Est. % of Disposed Waste	Est. Tons Disposed Statewide	Est. % of Disposed Waste	Est. Tons Disposed Statewide
Franchised Commercial	38.6%	11,909,937	49.6%	15,301,492
Franchised Residential	47.0%	14,516,212	30.0%	9,254,001
<i>Single-family residential</i>	35.4%	10,924,313	21.6%	6,662,188
<i>Multi-family residential</i>	11.6%	3,591,900	8.4%	2,591,814
Self-Hauled	14.4%	4,438,130	20.4%	6,308,785
<i>Commercial self-hauled</i>	11.3%	3,486,297	17.1%	5,285,747
<i>Residential self-hauled</i>	3.1%	951,833	3.3%	1,023,039
Totals	100.0%	30,864,279	100.0%	30,864,279

Numbers may not total exactly due to rounding. Source: 2014 vehicle survey findings and 2008 vehicle survey findings applied to individual facility records and CalRecycle Disposal Reporting System 2013 tonnage figures. See *Special Note Regarding Sector Percentages* on Page 3 for further explanation of sector percentage issues.

Quantities from Construction and Demolition (C&D) Activities

During the vehicle survey, additional information was collected from drivers to identify loads coming from C&D activities. The activities included:

- New Construction: waste generated during the construction of new buildings and structures.
- Remodeling: waste generated during the renovation of existing buildings.
- Demolition: waste generated by completely knocking down an existing building.
- Roofing: waste generated during the installation or replacement of roofs, including tear-off.
- Landscaping: Waste generated as part of landscaping and other yard care activities.
- All Other Waste: All materials not defined above.

The estimated quantity of construction debris disposed by each sector is summarized in Table 5. Results indicate that, based on the 2014 estimated sector percentages, an estimated 10 percent of the state’s disposed waste comes from C&D activities, and an estimated 16 percent is from C&D activities, based on the 2008 estimated sector

percentages. In the franchised commercial and franchised residential sectors, this waste is primarily delivered to the facilities in open roll-off containers. Waste generated by C&D activities accounts for an estimated 40 percent of the self-hauled sector based on the 2014 estimated sector percentages. This material is primarily delivered to the facilities in pick-up trucks, trailers, and other modified work vehicles.

Table 5: Estimated Quantities of Construction Debris, by Sector

Activity Type	Franchised Commercial		Franchised Residential		Self-Hauled		California Overall	
	Est. Using 2014 Sector %	Est. Using 2008 Sector %	Est. Using 2014 Sector %	Est. Using 2008 Sector %	Est. Using 2014 Sector %	Est. Using 2008 Sector %	Est. Using 2014 Sector %	Est. Using 2008 Sector %
New Construction	226,006	564,296	67,625	118,307	390,526	405,829	684,157	1,088,432
Remodeling	45,920	486,093	51,783	165,940	530,691	761,561	628,394	1,413,593
Demolition	577,119	345,632	112,687	302,869	689,578	1,079,302	1,379,383	1,727,802
Roofing	62,049	207,716	12,387	0	160,025	564,353	234,461	772,069
C&D Subtotal Tons	911,094	1,603,737	244,482	587,115	1,770,820	2,811,044	2,926,396	5,001,897
C&D Subtotal Percent	7.6%	10.5%	1.7%	6.3%	39.9%	44.6%	9.5%	16.2%
Landscaping	0	0	0	0	257,219	190,622	257,219	190,622
Other Waste	10,998,843	13,697,755	14,271,730	8,666,886	2,410,091	3,307,120	27,680,665	25,671,761
Other Subtotal	10,998,843	13,697,755	14,271,730	8,666,886	2,667,310	3,497,741	27,937,883	25,862,382
Total	11,909,937	15,301,492	14,516,212	9,254,001	4,438,130	6,308,785	30,864,279	30,864,279

Numbers may not total exactly due to rounding. Source: 2014 vehicle survey findings and 2008 vehicle survey findings applied to individual facility records and CalRecycle Disposal Reporting System 2013 tonnage figures. See *Special Note Regarding Sector Percentages* on Page 3 for further explanation of sector percentage issues.

Characterization Data

Overall Disposed Waste Stream

The objective of this section is to present the characterization data for the overall disposed municipal solid waste stream for the entire state of California, combining all of the sectors and subsectors considered elsewhere in this study.

Overview and Analysis

Composition estimates by **Material Class** for the overall waste stream are illustrated in Figure 5. The largest **Material Class** in the overall waste stream was **Other Organic**, which accounted for more than one-third (37 percent) of the waste stream, by weight, followed by **Inerts and Other** (20 percent) and **Paper** (17 percent).

Figure 5: Overview of California’s Overall Disposed Waste Stream

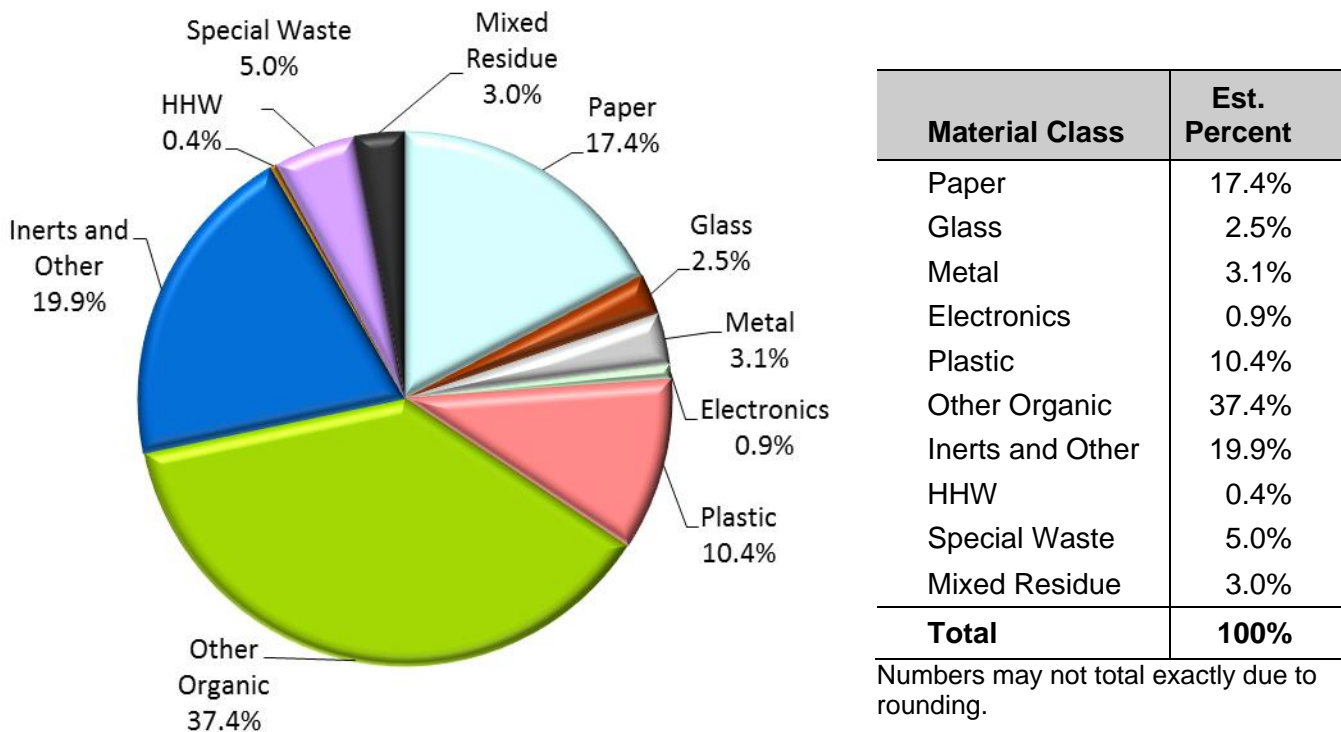

The above pie chart and table were constructed using sector percentage data obtained from the 2014 vehicle surveys applied to 2014 composition results. See *Special Note Regarding Sector Percentages* on Page 3 for a further explanation of the sector percentage issues.

Ten Most Prevalent Materials

Of the 10 most prevalent *material types* in the overall waste stream by weight, as shown in Table 6, four were compost/mulch materials, including *food, lumber, leaves and grass, and prunings and trimmings*. These materials accounted for almost 37 percent of the waste stream. *Textiles, other miscellaneous paper, and uncoated corrugated cardboard* are recoverable and together accounted for about 11 percent of the waste stream. Combined, the top 10 *material types* comprised approximately 64 percent of overall disposed waste.

Table 6: Ten Most Prevalent Material Types in California’s Overall Disposed Waste Stream

Material	Estimated Percent	Cumulative Percent	Estimated Tons
Food	18.1%	18.1%	5,591,179
Lumber	11.9%	30.0%	3,676,710
Remainder/Composite Paper	7.5%	37.6%	2,325,048
Bulky Items	4.4%	42.0%	1,365,340
Remainder/Composite Organic	4.3%	46.3%	1,323,465
Textiles	4.0%	50.3%	1,234,711
Other Miscellaneous Paper	3.9%	54.2%	1,215,919
Leaves and Grass	3.8%	58.0%	1,172,925
Uncoated Corrugated Cardboard	3.1%	61.1%	964,942
Prunings and Trimmings	3.1%	64.3%	962,262
Total	64.3%		19,832,501

Any differences between *cumulative percent* figures and the sum of *estimated percent* figures are due to rounding. The above table was constructed using sector percentage data obtained from the 2014 vehicle surveys applied to 2014 composition results. See *Special Note Regarding Sector Percentages* on Page 3 for a further explanation of the sector percentage issues.

As samples were sorted, the field crew estimated the proportion of *leaves and grass* that was leaves and the proportion that was grass. A total of 199 samples contained *leaves and grass*. Data from these samples were used to estimate that approximately 72 percent of the *leaves and grass* in California’s overall disposed waste was leaves.

Recoverability

Composition estimates by Recoverability Group for the overall waste stream are illustrated in Figure 6. The two largest Recoverability Groups in the overall waste stream were Compost/Mulch and Disposed which, by weight, accounted for more than 41 percent and 30 percent of the waste stream, respectively.

Figure 6: Recoverability of California's Overall Disposed Waste Stream

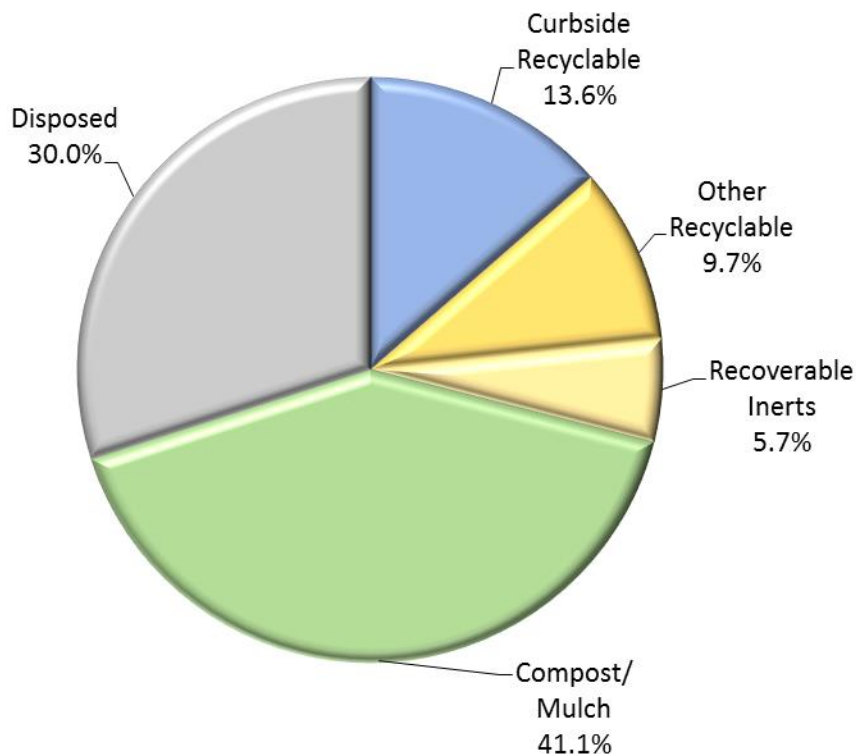

Recoverability Group	Est. Percent
Curbside Recyclable	13.6%
Other Recyclable	9.7%
Recoverable Inerts	5.7%
Compost/Mulch	41.1%
Disposed	30.0%
Total	100%

Numbers may not total exactly due to rounding. See Appendix B: List and Definitions of Material Types for listing of material types in each group.

The above pie chart and table were constructed using sector percentage data obtained from the 2014 vehicle surveys applied to 2014 composition results. See *Special Note Regarding Sector Percentages* on Page 3 for a further explanation of the sector percentage issues.

Detailed Composition

The composition percentages by weight for each *material type* in California's overall waste stream are listed in Table 7. Table 7 presents the 2014 sector percentages applied to the 2014 waste composition data and, for comparison, the sector percentages obtained in the 2008 Statewide Waste Characterization Study applied to the 2014 waste composition data. When comparing compositions from the two sets of data, composition percentages for most materials may be similar, but tonnage amounts can be very different. See *Special Note Regarding Sector Percentages* on Page 3 for a further explanation of the sector percentage issues.

Table 7: Composition of California's Overall Disposed Waste Stream

Material	Est. Using 2014 Sector Percentages			Est. Using 2008 Sector Percentages		
	Estimated Percent	+ / -	Estimated Tons	Estimated Percent	+ / -	Estimated Tons
Paper	17.4%		5,367,734	16.8%		5,176,996
Uncoated Corrugated Cardboard	3.1%	0.6%	964,942	3.7%	0.8%	1,152,480
Paper Bags	0.2%	0.0%	70,627	0.2%	0.0%	62,259
Newspaper	1.2%	0.4%	372,966	0.9%	0.3%	285,517
White Ledger Paper	0.4%	0.1%	121,637	0.4%	0.2%	132,219
Other Office Paper	0.3%	0.1%	103,845	0.3%	0.1%	89,177
Magazines and Catalogs	0.6%	0.1%	178,166	0.5%	0.1%	158,407
Phone Books and Directories	0.0%	0.0%	14,583	0.0%	0.0%	13,590
Other Miscellaneous Paper	3.9%	0.4%	1,215,919	3.8%	0.5%	1,164,676
Remainder/Composite Paper	7.5%	0.6%	2,325,048	6.9%	0.6%	2,118,672
Glass	2.5%		764,162	2.5%		770,530
Clear Glass Bottles and Containers	0.9%	0.1%	263,439	0.7%	0.1%	225,563
Green Glass Bottles and Containers	0.2%	0.1%	71,382	0.2%	0.1%	57,935
Brown Glass Bottles and Containers	0.4%	0.1%	111,432	0.3%	0.1%	104,175
Other Glass Colored Bottles and Containers	0.0%	0.0%	12,185	0.0%	0.0%	11,843
Flat Glass	0.1%	0.1%	42,481	0.2%	0.2%	56,510
Remainder/Composite Glass	0.9%	1.0%	263,243	1.0%	1.3%	314,504
Metal	3.1%		957,027	3.1%		964,502
Tin/Steel Cans	0.7%	0.1%	204,449	0.6%	0.2%	186,422
Major Appliances	0.2%	0.2%	50,251	0.1%	0.1%	29,000
Used Oil Filters	0.0%	0.0%	1,255	0.0%	0.0%	1,098
Other Ferrous	0.8%	0.2%	248,593	0.9%	0.3%	267,932
Aluminum Cans	0.2%	0.0%	47,233	0.1%	0.0%	42,696
Other Non-Ferrous	0.5%	0.2%	157,478	0.6%	0.3%	181,009
Remainder/Composite Metal	0.8%	0.2%	247,768	0.8%	0.3%	256,344
Electronics	0.9%		273,878	0.7%		230,498
Brown Goods	0.3%	0.2%	84,415	0.2%	0.1%	75,142
Computer-related Electronics	0.1%	0.1%	45,648	0.1%	0.1%	41,339
Other Small Consumer Electronics	0.2%	0.1%	68,932	0.2%	0.1%	54,457
Video Display Devices	0.2%	0.1%	74,883	0.2%	0.1%	59,560
Plastic	10.4%		3,215,943	10.4%		3,203,542
PETE Containers	0.6%	0.1%	197,202	0.6%	0.1%	179,529
HDPE Containers	0.5%	0.1%	139,189	0.4%	0.1%	136,693
Miscellaneous Plastic Containers	0.6%	0.1%	173,738	0.5%	0.1%	165,343
Plastic Trash Bags	1.2%	0.1%	383,130	1.2%	0.2%	379,315
Plastic Grocery and Other Merchandise Bags	0.5%	0.1%	157,395	0.4%	0.0%	128,298
Non-Bag Commercial and Industrial Packaging Film	0.3%	0.1%	83,192	0.3%	0.1%	102,661
Film Products	0.2%	0.3%	73,394	0.4%	0.5%	118,895
Other Film	1.8%	0.2%	543,476	1.7%	0.2%	523,211
Durable Plastic Items	2.2%	0.5%	682,812	2.2%	0.5%	671,213
Remainder/Composite Plastic	2.5%	0.3%	782,415	2.6%	0.5%	798,384

Confidence intervals calculated at the 90% confidence level. Percentages for material types may not total 100% due to rounding.

More detailed composition tables can be found in Appendix D: Expanded Statewide Waste Characterization Tables

The above table presents the 2014 sector percentages applied to the 2014 waste composition data and, for comparison, the sector percentages obtained in the 2008 Statewide Waste Characterization Study applied to the 2014 waste composition data. See *Special Note Regarding Sector Percentages* on Page 3 for a further explanation of the sector percentage issues.

Table 7 (continued): Composition of California's Overall Disposed Waste Stream

Material	Est. Using 2014 Sector Percentages			Est. Using 2008 Sector Percentages		
	Estimated Percent	+ / -	Estimated Tons	Estimated Percent	+ / -	Estimated Tons
Other Organic	37.4%		11,558,054	34.4%		10,614,389
Food	18.1%	1.6%	5,591,179	16.5%	1.8%	5,083,364
Leaves and Grass	3.8%	1.2%	1,172,925	3.4%	1.3%	1,048,621
Prunings and Trimmings	3.1%	1.0%	962,262	2.8%	1.0%	868,512
Branches and Stumps	1.7%	0.9%	528,493	1.8%	1.0%	544,872
Manures	0.6%	0.6%	174,808	0.7%	0.7%	214,875
Textiles	4.0%	0.7%	1,234,711	3.6%	0.7%	1,114,224
Carpet	1.8%	0.6%	570,212	2.0%	0.7%	605,950
Remainder/Composite Organic	4.3%	0.5%	1,323,465	3.7%	0.5%	1,133,971
Inerts and Other	19.9%		6,132,838	23.5%		7,265,537
Concrete	1.2%	0.4%	373,185	1.3%	0.5%	415,287
Asphalt Paving	0.2%	0.3%	70,269	0.4%	0.7%	130,364
Asphalt Roofing	0.7%	0.4%	223,236	0.8%	0.6%	251,150
Lumber	11.9%	1.8%	3,676,710	13.7%	2.0%	4,229,070
Gypsum Board	1.1%	0.4%	327,002	1.3%	0.5%	401,684
Rock, Soil and Fines	2.4%	0.7%	750,357	2.9%	1.0%	896,129
Remainder/Composite Inerts and Other	2.3%	0.7%	712,079	3.1%	1.1%	941,853
Household Hazardous Waste (HHW)	0.4%		109,568	0.3%		78,461
Paint	0.2%	0.1%	48,951	0.1%	0.1%	31,414
Vehicle & Equipment Fluids	0.0%	0.0%	219	0.0%	0.0%	88
Used Oil	0.0%	0.0%	1,410	0.0%	0.0%	939
Batteries	0.0%	0.0%	11,887	0.0%	0.0%	10,894
Remainder/Composite Household Hazardous	0.2%	0.1%	47,102	0.1%	0.1%	35,125
Special Waste	5.0%		1,558,079	5.8%		1,803,511
Ash	0.1%	0.0%	16,138	0.1%	0.1%	17,409
Treated Medical Waste	0.1%	0.2%	34,909	0.1%	0.1%	30,645
Bulky Items	4.4%	1.3%	1,365,340	5.1%	1.4%	1,574,149
Tires	0.1%	0.1%	39,393	0.1%	0.1%	39,308
Remainder/Composite Special Waste	0.3%	0.3%	102,299	0.5%	0.4%	142,000
Mixed Residue	3.0%		926,996	2.5%		756,314
Totals	100.0%		30,864,279	100.0%		30,864,279
Sample Count	754			754		

Confidence intervals calculated at the 90% confidence level. Percentages for material types may not total 100% due to rounding.

More detailed composition tables can be found in Appendix D: Expanded Statewide Waste Characterization Tables

The above table presents the 2014 sector percentages applied to the 2014 waste composition data and, for comparison, the sector percentages obtained in the 2008 Statewide Waste Characterization Study applied to the 2014 waste composition data. See *Special Note Regarding Sector Percentages* on Page 3 for a further explanation of the sector percentage issues.

Franchised Commercial Waste

The objective of this section is to present the characterization data for California's disposed waste from commercial, institutional, and industrial sources. Franchised commercial waste is defined as waste disposed by businesses, industries, and public organizations that is collected and transported by contracted or franchised waste haulers, both private and public (municipal). This includes waste delivered to disposal facilities by both packer trucks serving businesses on regular routes and loose or compacted drop boxes serving individual sites.

Overview and Analysis

Samples of franchised commercial waste were obtained from randomly selected vehicles at the landfills and transfer stations participating in this study. Composition percentage and estimated tons for each material were derived by combining data at the regional level with weighting proportionate to the estimated amount of franchised commercial waste disposed in each region, as derived from the vehicle surveys. Since tonnage amounts for the commercial and other sectors were very different from past studies, sector percentages and compositions were also calculated using 2008 vehicle survey data. See *Special Note Regarding Sector Percentages* on Page 3 for further explanation of sector percentage issues.

As shown in Table 4, the franchised commercial sector accounts for approximately 39 percent of California's municipal solid waste stream using 2014 sector percentages from vehicle surveys, and nearly 50 percent using 2008 sector percentages. See Appendix A: Detailed Methodology for a description of the methods used in selecting, sorting, and analyzing samples.

Table 8 presents the numbers of samples that were obtained in each region and each season for franchised commercial waste. In total, 251 samples of commercial waste were analyzed.

Table 8: Franchised Commercial Samples Obtained, by Region and Season

Season	Bay Area	Coastal	Mountain	Southern	Valley	Totals
Winter 2014	15	8	15	10	10	58
Spring 2014	9	13	8	15	12	57
Summer 2014	19	8	17	10	11	65
Fall 2014	7	21	11	15	17	71
Totals	50	50	51	50	50	251

See Appendix A: Detailed Methodology for the names and locations of the solid waste facilities that were visited.

Composition results by **Material Class** for franchised commercial waste are illustrated in Figure 7 and described in detail in Table 10. The largest **Material Classes** in the franchised commercial waste stream were **Paper** and **Other Organic**, which accounted for about 20 percent and 35 percent of the total, respectively.

Figure 7: Overview of Franchised Commercial Disposed Waste

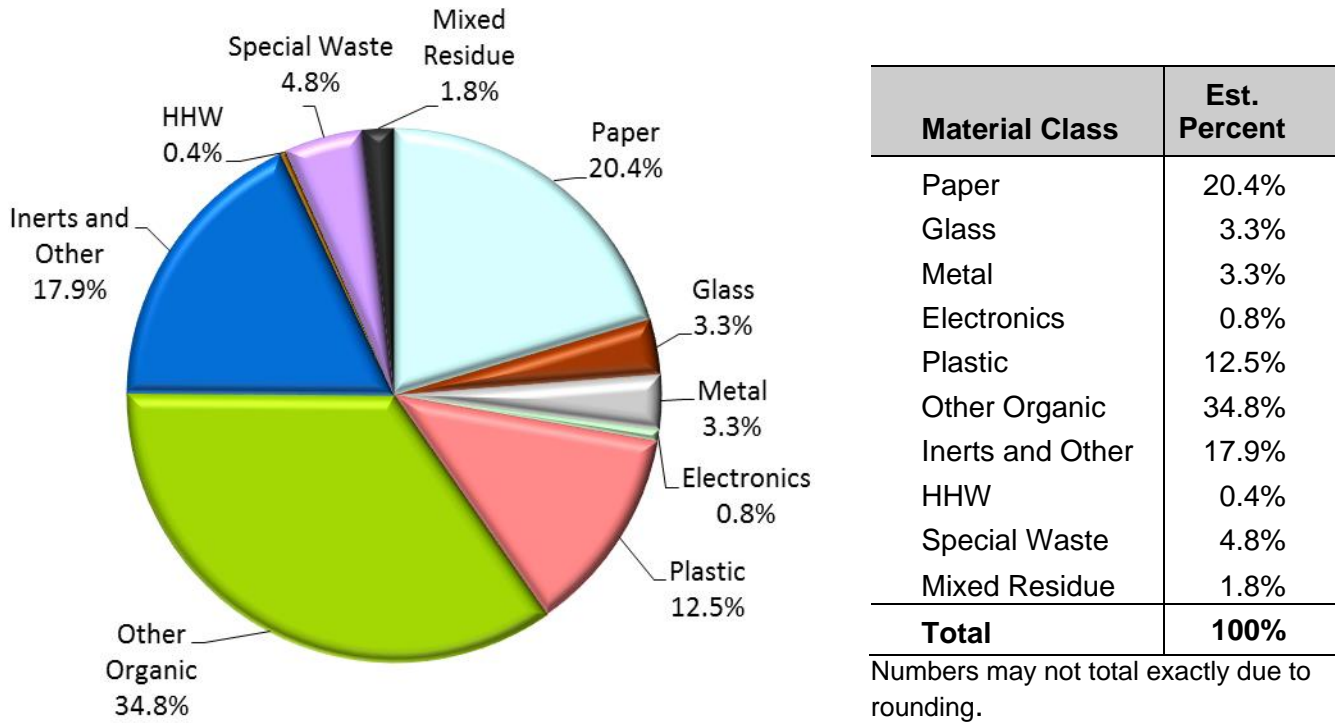

The above pie chart and table were constructed using sector percentage data obtained from the 2014 vehicle surveys applied to 2014 composition results. See *Special Note Regarding Sector Percentages* on Page 3 for a further explanation of the sector percentage issues.

Ten Most Prevalent Materials

The 10 most prevalent *material types* (Table 9) accounted for about 66 percent of franchised commercial waste. The recoverable materials *uncoated corrugated cardboard, other miscellaneous paper, textiles, and durable plastic items* made up about 15 percent of the franchised commercial waste stream. Compost/mulch materials accounted for more than 35 percent of the waste stream, with *food* being the most prevalent at more than 20 percent of disposed waste.

Table 9: Ten Most Prevalent Material Types in Franchised Commercial Disposed Waste

Material	Estimated Percent	Cumulative Percent	Estimated Tons
Food	20.1%	20.1%	2,390,922
Lumber	12.1%	32.2%	1,439,830
Remainder/Composite Paper	8.6%	40.8%	1,024,392
Uncoated Corrugated Cardboard	5.0%	45.8%	594,130
Other Miscellaneous Paper	4.5%	50.3%	538,817
Bulky Items	3.8%	54.1%	457,451
Leaves and Grass	3.2%	57.3%	377,741
Textiles	3.1%	60.4%	365,829
Durable Plastic Items	2.7%	63.1%	327,497
Remainder/Composite Organic	2.7%	65.8%	325,554
Total	65.8%		7,842,164

Any differences between *cumulative percent* figures and the sum of *estimated percent* figures are due to rounding. The above table was constructed using sector percentage data obtained from the 2014 vehicle surveys applied to 2014 composition results. See *Special Note Regarding Sector Percentages* on Page 3 for a further explanation of the sector percentage issues.

As samples were sorted, the field crew estimated the proportion of *leaves and grass* that was leaves and the proportion that was grass. Sixty-one franchised commercial samples contained *leaves and grass*. Data from these samples were used to estimate that leaves were approximately 78 percent, by weight, of the disposed *leaves and grass* in the franchised commercial waste stream.

Recoverability

Composition estimates by Recoverability Group for the franchised commercial waste stream are illustrated in Figure 8. The Compost/Mulch group accounted for 45 percent of the waste stream. The Disposed group (27 percent) was the majority of the remaining materials.

Figure 8: Recoverability of Franchised Commercial Disposed Waste

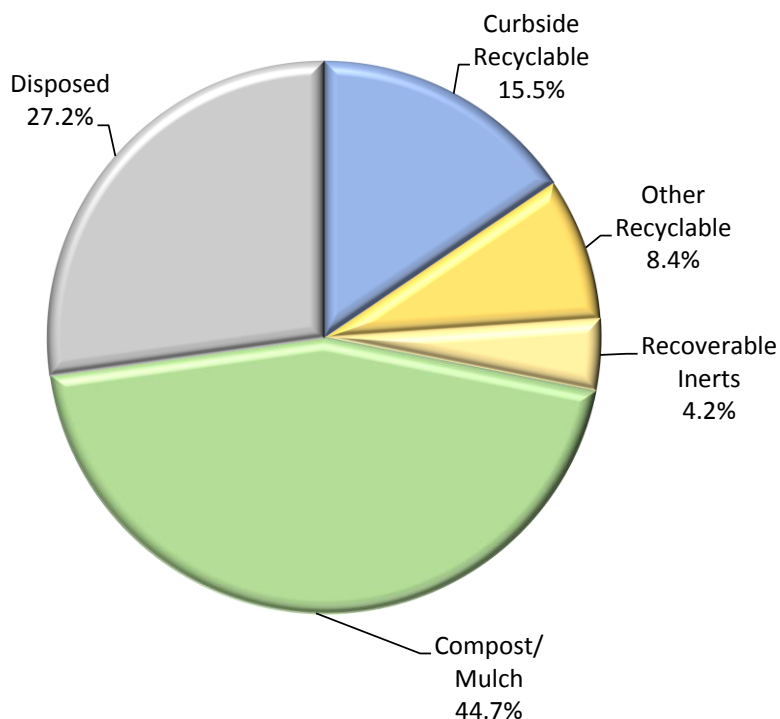

Recoverability Group	Est. Percent
Curbside Recyclable	15.5%
Other Recyclable	8.4%
Recoverable Inerts	4.2%
Compost/Mulch	44.7%
Disposed	27.2%
Total	100%

Numbers may not total exactly due to rounding. See Appendix B: List and Definitions of Material Types for listing of material types in each group.

The above pie chart and table were constructed using sector percentage data obtained from the 2014 vehicle surveys applied to 2014 composition results. See *Special Note Regarding Sector Percentages* on Page 3 for a further explanation of the sector percentage issues.

Detailed Composition

Table 10 presents detailed composition results for the franchised commercial waste stream. Table 10 presents the 2014 sector percentages applied to the 2014 waste composition data and, for comparison, the sector percentages obtained in the 2008 Statewide Waste Characterization Study applied to the 2014 waste composition data. When comparing compositions from the two sets of data, composition percentages for most materials may be similar, but tonnage amounts can be very different. See *Special Note Regarding Sector Percentages* on Page 3 for a further explanation of the sector percentage issues.

Table 10: Composition of Franchised Commercial Disposed Waste

Material	Est. Using 2014 Sector Percentages			Est. Using 2008 Sector Percentages		
	Estimated Percent	+ / -	Estimated Tons	Estimated Percent	+ / -	Estimated Tons
Paper	20.4%		2,433,919	20.4%		3,125,821
Uncoated Corrugated Cardboard	5.0%	1.3%	594,130	5.5%	1.6%	834,744
Paper Bags	0.2%	0.1%	20,301	0.2%	0.1%	24,107
Newspaper	0.5%	0.2%	64,998	0.5%	0.2%	74,164
White Ledger Paper	0.7%	0.3%	79,000	0.7%	0.4%	103,180
Other Office Paper	0.3%	0.2%	36,780	0.3%	0.2%	47,225
Magazines and Catalogs	0.6%	0.2%	70,156	0.6%	0.2%	85,920
Phone Books and Directories	0.0%	0.0%	5,345	0.0%	0.0%	5,982
Other Miscellaneous Paper	4.5%	0.9%	538,817	4.6%	1.0%	705,700
Remainder/Composite Paper	8.6%	1.2%	1,024,392	8.1%	1.2%	1,244,799
Glass	3.3%		396,766	3.3%		504,813
Clear Glass Bottles and Containers	0.7%	0.2%	89,289	0.7%	0.2%	106,183
Green Glass Bottles and Containers	0.2%	0.1%	25,737	0.2%	0.1%	31,183
Brown Glass Bottles and Containers	0.3%	0.2%	39,919	0.4%	0.2%	54,608
Other Glass Colored Bottles and Containers	0.1%	0.0%	6,148	0.1%	0.0%	8,032
Flat Glass	0.1%	0.2%	17,752	0.2%	0.3%	30,519
Remainder/Composite Glass	1.8%	2.7%	217,921	1.8%	2.6%	274,288
Metal	3.3%		388,592	3.3%		509,642
Tin/Steel Cans	0.6%	0.2%	72,630	0.6%	0.3%	94,784
Major Appliances	0.1%	0.2%	11,579	0.1%	0.1%	9,933
Used Oil Filters	0.0%	0.0%	571	0.0%	0.0%	530
Other Ferrous	1.0%	0.5%	116,050	1.0%	0.6%	159,457
Aluminum Cans	0.1%	0.0%	17,849	0.1%	0.0%	21,887
Other Non-Ferrous	0.6%	0.5%	70,831	0.7%	0.6%	106,687
Remainder/Composite Metal	0.8%	0.5%	99,081	0.8%	0.5%	116,364
Electronics	0.8%		90,112	0.6%		98,418
Brown Goods	0.3%	0.2%	39,470	0.3%	0.2%	48,314
Computer-related Electronics	0.1%	0.1%	12,304	0.1%	0.1%	15,745
Other Small Consumer Electronics	0.1%	0.0%	7,998	0.1%	0.0%	8,679
Video Display Devices	0.3%	0.2%	30,339	0.2%	0.2%	25,680
Plastic	12.5%		1,491,458	12.5%		1,911,140
PETE Containers	0.7%	0.3%	82,366	0.7%	0.3%	101,303
HDPE Containers	0.6%	0.2%	68,351	0.6%	0.2%	89,048
Miscellaneous Plastic Containers	0.7%	0.2%	80,664	0.7%	0.2%	101,376
Plastic Trash Bags	1.7%	0.3%	208,401	1.7%	0.3%	257,351
Plastic Grocery and Other Merchandise Bags	0.3%	0.1%	41,200	0.3%	0.1%	50,313
Non-Bag Commercial and Industrial Packaging Film	0.5%	0.2%	60,149	0.6%	0.2%	84,731
Film Products	0.5%	0.7%	59,992	0.7%	1.0%	99,783
Other Film	2.1%	0.3%	251,568	2.1%	0.4%	316,817
Durable Plastic Items	2.7%	1.0%	327,497	2.6%	0.9%	402,091
Remainder/Composite Plastic	2.6%	0.5%	311,270	2.7%	0.6%	408,328

Confidence intervals calculated at the 90% confidence level. Percentages for material types may not total 100% due to rounding.

More detailed composition tables can be found in Appendix D: Expanded Statewide Waste Characterization Tables

The above table presents the 2014 sector percentages applied to the 2014 waste composition data and, for comparison, the sector percentages obtained in the 2008 Statewide Waste Characterization Study applied to the 2014 waste composition data. See *Special Note Regarding Sector Percentages* on Page 3 for a further explanation of the sector percentage issues.

Table 10 (continued): Composition of Franchised Commercial Disposed Waste

Material	Est. Using 2014 Sector Percentages			Est. Using 2008 Sector Percentages		
	Estimated Percent	+ / -	Estimated Tons	Estimated Percent	+ / -	Estimated Tons
Other Organic	34.8%		4,145,711	33.5%		5,129,480
Food	20.1%	3.6%	2,390,922	18.9%	3.5%	2,898,430
Leaves and Grass	3.2%	2.2%	377,741	3.2%	2.2%	493,850
Prunings and Trimmings	1.8%	1.2%	211,250	1.7%	1.2%	266,838
Branches and Stumps	1.7%	1.7%	208,413	1.8%	1.7%	270,765
Manures	1.3%	1.4%	150,455	1.2%	1.4%	190,421
Textiles	3.1%	1.2%	365,829	3.1%	1.2%	470,895
Carpet	1.0%	0.9%	115,547	0.9%	0.9%	145,080
Remainder/Composite Organic	2.7%	0.7%	325,554	2.6%	0.7%	393,202
Inerts and Other	17.9%		2,132,837	19.1%		2,917,350
Concrete	0.8%	0.4%	91,170	0.8%	0.4%	116,687
Asphalt Paving	0.0%	0.1%	4,779	0.0%	0.1%	7,160
Asphalt Roofing	0.7%	0.8%	79,640	0.8%	1.1%	127,424
Lumber	12.1%	2.8%	1,439,830	12.9%	3.1%	1,974,164
Gypsum Board	0.8%	0.5%	94,022	0.7%	0.4%	109,892
Rock, Soil and Fines	1.9%	1.0%	230,508	2.2%	1.2%	334,418
Remainder/Composite Inerts and Other	1.6%	1.1%	192,888	1.6%	1.1%	247,605
Household Hazardous Waste (HHW)	0.4%		41,716	0.3%		39,885
Paint	0.2%	0.3%	22,987	0.1%	0.2%	20,648
Vehicle & Equipment Fluids	0.0%	0.0%	0	0.0%	0.0%	0
Used Oil	0.0%	0.0%	661	0.0%	0.0%	565
Batteries	0.0%	0.0%	3,130	0.0%	0.0%	3,722
Remainder/Composite Household Hazardous	0.1%	0.1%	14,938	0.1%	0.1%	14,950
Special Waste	4.8%		568,604	5.2%		796,806
Ash	0.1%	0.1%	11,407	0.1%	0.1%	13,755
Treated Medical Waste	0.0%	0.1%	5,118	0.1%	0.1%	7,668
Bulky Items	3.8%	1.8%	457,451	4.2%	1.9%	637,312
Tires	0.0%	0.0%	4,238	0.0%	0.1%	6,026
Remainder/Composite Special Waste	0.8%	0.7%	90,389	0.9%	0.8%	132,045
Mixed Residue	1.8%		220,222	1.8%		268,138
Totals	100.0%		11,909,937	100.0%		15,301,492
Sample Count	251			251		

Confidence intervals calculated at the 90% confidence level. Percentages for material types may not total 100% due to rounding.

More detailed composition tables can be found in Appendix D: Expanded Statewide Waste Characterization Tables

The above table presents the 2014 sector percentages applied to the 2014 waste composition data and, for comparison, the sector percentages obtained in the 2008 Statewide Waste Characterization Study applied to the 2014 waste composition data. See *Special Note Regarding Sector Percentages* on Page 3 for a further explanation of the sector percentage issues.

Franchised Residential Waste

The objective of this section is to present the characterization data for California's franchised residential waste stream at the state level. Franchised residential waste is defined as waste disposed by households that is collected and transported by contracted or franchised waste haulers, both private and public (municipal). This section presents composition findings for the statewide franchised residential sector as a whole, followed by findings for single-family residential waste and multi-family residential waste.

Overview and Analysis

Since tonnage amounts for the residential and other sectors were very different from past studies, sector percentages and compositions were calculated using both 2014 and 2008 vehicle survey data. See Special Note Regarding Sector Percentages for further explanation of sector percentage issues.

Based on the 2014 estimated sector percentages, the franchised residential sector accounts for approximately 47 percent of California's municipal solid waste stream. The single-family residential subsector accounts for approximately 35 percent, and the multi-family residential subsector accounts for approximately 12 percent.

Based on the 2008 estimated sector percentages, the franchised residential sector accounts for approximately 30 percent of California's municipal solid waste stream. The single-family residential subsector accounts for approximately 22 percent, and the multi-family residential subsector accounts for approximately 8 percent.

As with many waste composition studies, this study considered single-family residential waste separately from multi-family residential waste. Multi-family waste is typically collected along with commercial waste, and it becomes impractical to separate the multi-family from the commercial waste for sampling at solid waste sites. The present study therefore captured multi-family waste at the point of generation (apartment complexes).

Samples of single-family residential waste were obtained from randomly selected vehicles at the landfills and transfer stations that participated in this study. Samples of multi-family residential waste were collected at multi-family complexes that were selected randomly from the area surrounding the participating solid waste facilities. Composition percentages and estimated tons for each material type were derived separately for the single-family residential and multi-family residential subsectors. The estimates for the two subsectors were then combined, with weighting proportionate to the prevalence of each subsector in the overall waste stream, as derived from the vehicle surveys. See Appendix A: Detailed Methodology for a description of the methods used in selecting, sorting, and analyzing samples.

Table 13 and Table 16 present the numbers of samples that were obtained in each region and each season for single-family residential waste and multi-family residential waste, respectively. In all, 253 samples of franchised residential waste were analyzed (201 single-family and 52 multi-family).

Composition results by **Material Class** for franchised residential disposed waste are illustrated in Figure 9 and described in detail in Table 12. A large portion—an estimated 45 percent—of the franchised residential waste stream was composed of **Other Organic** material. The next largest class was **Paper**, an estimated 19 percent.

Figure 9: Overview of Franchised Residential Disposed Waste

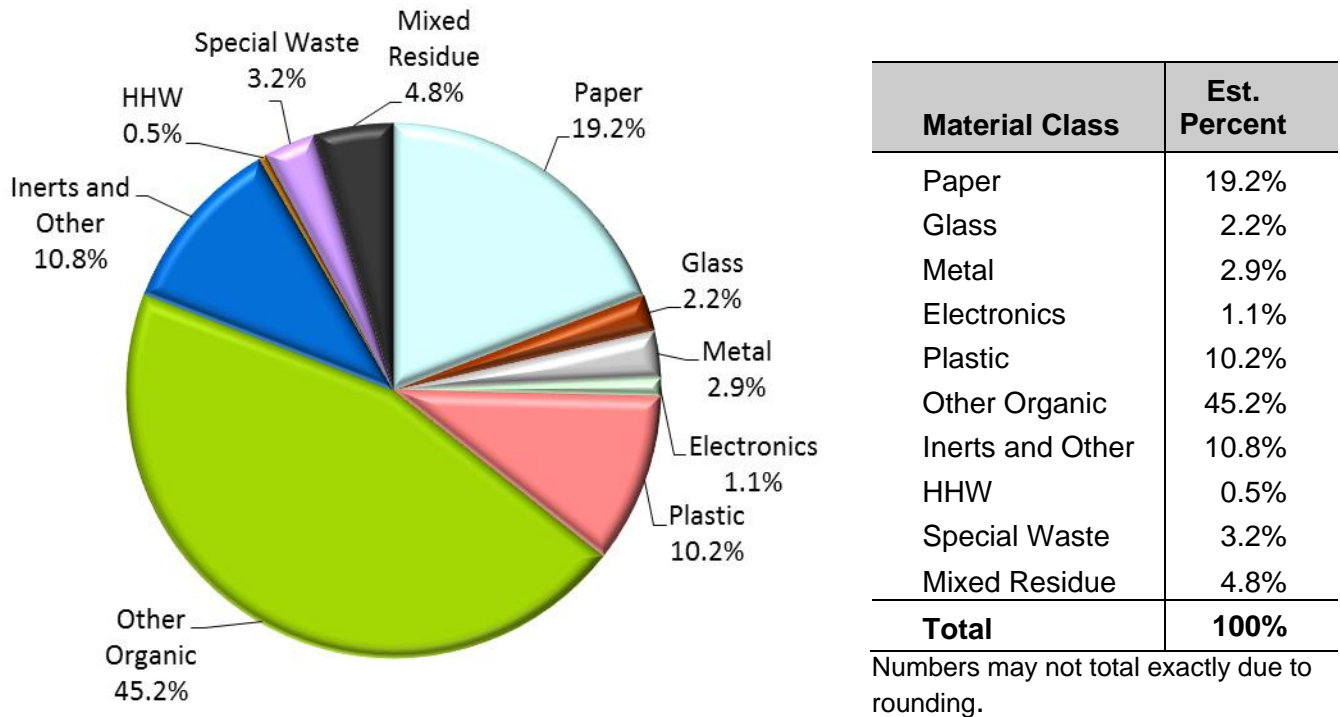

The above pie chart and table were constructed using sector percentage data obtained from the 2014 vehicle surveys applied to 2014 composition results. See *Special Note Regarding Sector Percentages* on Page 3 for a further explanation of the sector percentage issues.

Ten Most Prevalent Materials

The 10 most prevalent *material types*, shown in Table 11, accounted for almost 70 percent of franchised residential waste. Almost 37 percent of these materials are compost/mulch materials, including *food, lumber, leaves and grass, and prunings and trimmings*. Other recoverable items included *textiles*, and *other miscellaneous paper* which accounted for approximately 10 percent.

Table 11: Ten Most Prevalent Material Types in Franchised Residential Disposed Waste

Material	Estimated Percent	Cumulative Percent	Estimated Tons
Food	21.9%	21.9%	3,181,722
Remainder/Composite Paper	8.8%	30.7%	1,281,118
Lumber	6.8%	37.5%	980,477
Remainder/Composite Organic	6.5%	44.0%	940,299
Textiles	5.5%	49.5%	796,134
Mixed Residue	4.8%	54.2%	690,941
Leaves and Grass	4.6%	58.8%	663,657
Other Miscellaneous Paper	4.5%	63.3%	652,181
Prunings and Trimmings	3.8%	67.1%	553,083
Bulky Items	2.8%	69.9%	400,375
Total	69.9%		10,139,986

Any differences between *cumulative percent* figures and the sum of *estimated percent* figures are due to rounding. The above table was constructed using sector percentage data obtained from the 2014 vehicle surveys applied to 2014 composition results. See *Special Note Regarding Sector Percentages* on Page 3 for a further explanation of the sector percentage issues.

As samples were sorted the field crew estimated the proportion of *leaves and grass* that was leaves and the proportion that was grass. There were 108 franchised residential samples containing *leaves and grass*. Data from these samples were used to estimate that leaves were approximately 70 percent, by weight, of the disposed *leaves and grass* in the franchised residential waste stream.

Recoverability

As shown in Figure 10, Compost/Mulch was the largest Recoverability Group in the franchised residential waste stream. It accounted for about 43 percent of the waste stream by weight. It was followed by Curbside Recyclable (15 percent), Other Recyclable (11 percent), and Recoverable Inerts (3 percent). The Disposed group accounted for 28 percent of the waste stream.

Figure 10: Recoverability of Franchised Residential Disposed Waste

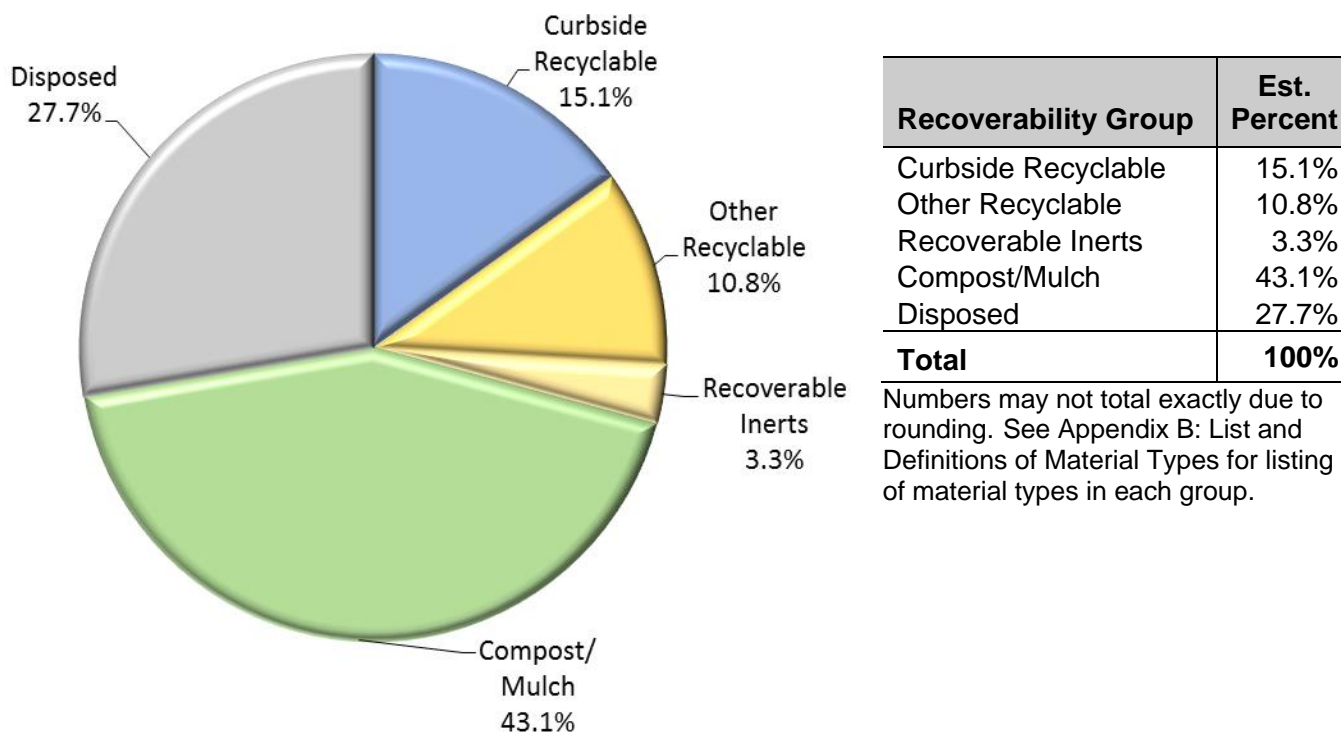

The above pie chart and table were constructed using sector percentage data obtained from the 2014 vehicle surveys applied to 2014 composition results. See *Special Note Regarding Sector Percentages* on Page 3 for a further explanation of the sector percentage issues.

Detailed Composition

Table 12 presents the composition percentages, by weight, for each *material type* in the overall franchised residential sector. Table 12 presents the 2014 sector percentages applied to the 2014 waste composition data and, for comparison, the sector percentages obtained in the 2008 Statewide Waste Characterization Study applied to the 2014 waste composition data. When comparing compositions from the two sets of data, composition percentages for most materials may be similar, but tonnage amounts can be very different. See *Special Note Regarding Sector Percentages* on Page 3 for a further explanation of the sector percentage issues.

Table 12: Composition of Franchised Residential Disposed Waste

Material	Est. Using 2014 Sector Percentages			Est. Using 2008 Sector Percentages		
	Estimated Percent	+ / -	Estimated Tons	Estimated Percent	+ / -	Estimated Tons
Paper	19.2%		2,787,295	19.9%		1,844,685
Uncoated Corrugated Cardboard	2.0%	0.5%	286,560	2.1%	0.5%	193,069
Paper Bags	0.3%	0.0%	44,643	0.3%	0.1%	32,180
Newspaper	2.1%	0.9%	306,380	2.3%	1.1%	209,092
White Ledger Paper	0.3%	0.1%	40,663	0.3%	0.1%	26,965
Other Office Paper	0.5%	0.1%	65,843	0.4%	0.1%	40,700
Magazines and Catalogs	0.7%	0.2%	103,513	0.7%	0.1%	67,608
Phone Books and Directories	0.0%	0.0%	6,393	0.0%	0.0%	3,911
Other Miscellaneous Paper	4.5%	0.5%	652,181	4.6%	0.4%	422,384
Remainder/Composite Paper	8.8%	0.8%	1,281,118	9.2%	0.7%	848,776
Glass	2.2%		320,710	2.3%		212,099
Clear Glass Bottles and Containers	1.2%	0.2%	169,409	1.2%	0.2%	113,778
Green Glass Bottles and Containers	0.3%	0.1%	44,990	0.3%	0.1%	25,983
Brown Glass Bottles and Containers	0.5%	0.2%	68,857	0.5%	0.2%	46,666
Other Glass Colored Bottles and Containers	0.0%	0.0%	5,980	0.0%	0.0%	3,751
Flat Glass	0.0%	0.0%	2,426	0.0%	0.0%	2,063
Remainder/Composite Glass	0.2%	0.1%	29,048	0.2%	0.1%	19,858
Metal	2.9%		415,855	2.8%		258,576
Tin/Steel Cans	0.8%	0.1%	121,945	0.9%	0.1%	81,232
Major Appliances	0.2%	0.4%	34,497	0.2%	0.2%	13,941
Used Oil Filters	0.0%	0.0%	551	0.0%	0.0%	265
Other Ferrous	0.6%	0.2%	89,116	0.6%	0.2%	54,103
Aluminum Cans	0.2%	0.0%	29,009	0.2%	0.1%	20,325
Other Non-Ferrous	0.4%	0.2%	65,004	0.4%	0.1%	39,371
Remainder/Composite Metal	0.5%	0.2%	75,733	0.5%	0.1%	49,338
Electronics	1.1%		160,785	1.1%		104,806
Brown Goods	0.3%	0.3%	41,356	0.2%	0.2%	23,050
Computer-related Electronics	0.2%	0.1%	24,900	0.2%	0.1%	17,046
Other Small Consumer Electronics	0.4%	0.1%	55,080	0.4%	0.1%	36,840
Video Display Devices	0.3%	0.2%	39,448	0.3%	0.2%	27,870
Plastic	10.2%		1,485,047	10.6%		982,590
PETE Containers	0.8%	0.1%	110,485	0.8%	0.1%	73,398
HDPE Containers	0.5%	0.1%	70,002	0.5%	0.1%	46,555
Miscellaneous Plastic Containers	0.6%	0.1%	92,246	0.7%	0.1%	63,019
Plastic Trash Bags	1.2%	0.1%	170,878	1.3%	0.1%	116,399
Plastic Grocery and Other Merchandise Bags	0.8%	0.1%	115,352	0.8%	0.1%	77,032
Non-Bag Commercial and Industrial Packaging Film	0.1%	0.1%	19,648	0.2%	0.1%	14,243
Film Products	0.0%	0.0%	5,056	0.0%	0.1%	4,392
Other Film	2.0%	0.3%	285,752	2.1%	0.3%	198,344
Durable Plastic Items	1.8%	0.5%	254,589	1.6%	0.4%	148,916
Remainder/Composite Plastic	2.5%	0.3%	361,040	2.6%	0.4%	240,292

Confidence intervals calculated at the 90% confidence level. Percentages for material types may not total 100% due to rounding.

More detailed composition tables can be found in Appendix D: Expanded Statewide Waste Characterization Tables

The above table presents the 2014 sector percentages applied to the 2014 waste composition data and, for comparison, the sector percentages obtained in the 2008 Statewide Waste Characterization Study applied to the 2014 waste composition data. See *Special Note Regarding Sector Percentages* on Page 3 for a further explanation of the sector percentage issues.

Table 12 (continued): Composition of Franchised Residential Disposed Waste

Material	Est. Using 2014 Sector Percentages			Est. Using 2008 Sector Percentages		
	Estimated Percent	+ / -	Estimated Tons	Estimated Percent	+ / -	Estimated Tons
Other Organic	45.2%		6,568,469	45.3%		4,195,576
Food	21.9%	1.8%	3,181,722	23.4%	1.7%	2,161,842
Leaves and Grass	4.6%	1.7%	663,657	3.7%	1.2%	343,107
Prunings and Trimmings	3.8%	1.6%	553,083	2.9%	1.1%	265,433
Branches and Stumps	1.5%	1.3%	211,735	1.0%	0.8%	96,134
Manures	0.0%	0.0%	3,164	0.0%	0.0%	3,224
Textiles	5.5%	1.1%	796,134	5.9%	1.3%	547,039
Carpet	1.5%	0.8%	218,677	1.4%	0.7%	133,515
Remainder/Composite Organic	6.5%	0.8%	940,299	7.0%	0.8%	645,282
Inerts and Other	10.8%		1,563,611	9.3%		859,714
Concrete	0.8%	0.5%	110,983	0.7%	0.3%	60,694
Asphalt Paving	0.0%	0.0%	0	0.0%	0.0%	0
Asphalt Roofing	0.5%	0.5%	65,708	0.3%	0.3%	29,727
Lumber	6.8%	2.8%	980,477	5.9%	2.2%	545,715
Gypsum Board	0.3%	0.2%	40,795	0.3%	0.1%	26,760
Rock, Soil and Fines	1.8%	0.6%	256,402	1.4%	0.4%	131,074
Remainder/Composite Inerts and Other	0.8%	0.4%	109,246	0.7%	0.3%	65,744
Household Hazardous Waste (HHW)	0.5%		66,169	0.4%		36,596
Paint	0.2%	0.2%	25,885	0.1%	0.1%	10,686
Vehicle & Equipment Fluids	0.0%	0.0%	219	0.0%	0.0%	88
Used Oil	0.0%	0.0%	711	0.0%	0.0%	287
Batteries	0.1%	0.0%	8,500	0.1%	0.0%	6,827
Remainder/Composite Household Hazardous	0.2%	0.1%	30,854	0.2%	0.1%	18,707
Special Waste	3.2%		457,330	3.1%		288,137
Ash	0.0%	0.0%	3,944	0.0%	0.0%	2,838
Treated Medical Waste	0.2%	0.3%	29,791	0.2%	0.4%	22,977
Bulky Items	2.8%	1.9%	400,375	2.6%	1.6%	242,907
Tires	0.1%	0.1%	11,368	0.1%	0.2%	9,533
Remainder/Composite Special Waste	0.1%	0.0%	11,852	0.1%	0.1%	9,883
Mixed Residue	4.8%		690,941	5.1%		471,223
Totals	100.0%		14,516,212	100.0%		9,254,001
Sample Count	253			253		

Confidence intervals calculated at the 90% confidence level. Percentages for material types may not total 100% due to rounding.

More detailed composition tables can be found in Appendix D: Expanded Statewide Waste Characterization Tables

The above table presents the 2014 sector percentages applied to the 2014 waste composition data and, for comparison, the sector percentages obtained in the 2008 Statewide Waste Characterization Study applied to the 2014 waste composition data. See *Special Note Regarding Sector Percentages* on Page 3 for a further explanation of the sector percentage issues.

Single-Family Residential Waste

The objective of this section is to present the characterization data for California's single-family residential waste stream at the state level. This is a subsector of the franchised residential waste stream, and includes waste that is collected by haulers from single-family residences.

Overview and Analysis

Samples of single-family residential waste were obtained from randomly selected vehicles at the landfills and transfer stations participating in this study. See Appendix A: Detailed Methodology for a description of the methods used in selecting, sorting, and analyzing samples.

Table 13 presents the numbers of samples that were obtained in each region and each season. Statewide, 201 samples of single-family residential waste were collected and sorted.

Table 13: Single-Family Residential Samples Obtained, by Region and Season

Season	Bay Area	Coastal	Mountain	Southern	Valley	Totals
Winter 2014	7	6	10	7	7	37
Spring 2014	7	9	8	8	13	45
Summer 2014	20	11	16	11	11	69
Fall 2014	6	15	6	14	9	50
Totals	40	41	40	40	40	201

See Appendix A: Detailed Methodology for the names and locations of the solid waste facilities that were visited.

Composition results by **Material Class** for single-family residential waste are illustrated in Figure 11 and described in detail in Table 15. The largest **Material Class** in the single-family residential waste stream was **Other Organic**, which accounted for nearly 46 percent of the total by weight. **Paper**, the next largest **Material Class**, accounted for almost 18 percent.

Figure 11: Overview of Single-Family Residential Disposed Waste

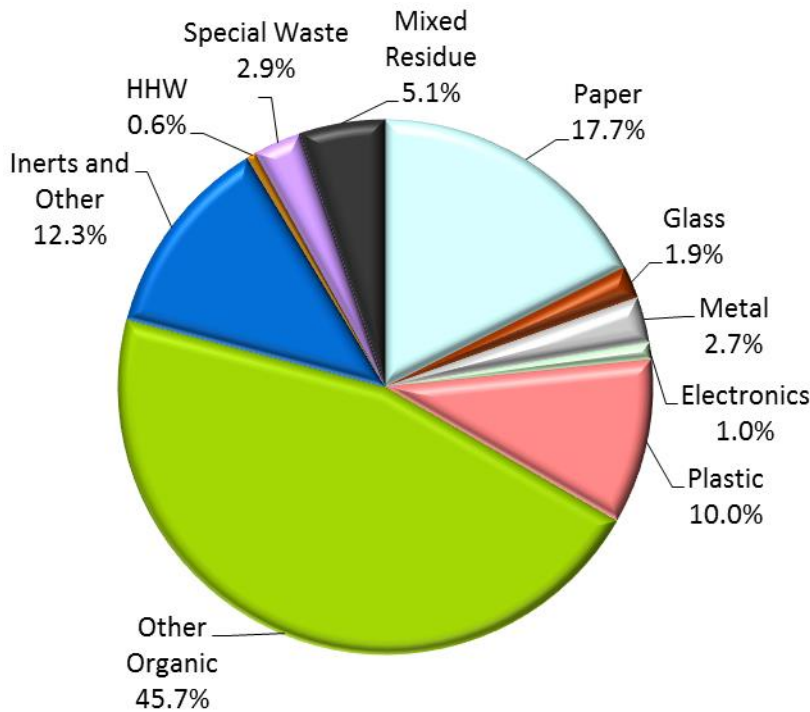

Material Class	Est. Percent
Paper	17.7%
Glass	1.9%
Metal	2.7%
Electronics	1.0%
Plastic	10.0%
Other Organic	45.7%
Inerts and Other	12.3%
HHW	0.6%
Special Waste	2.9%
Mixed Residue	5.1%
Total	100%

Numbers may not total exactly due to rounding.

The above pie chart and table were constructed using sector percentage data obtained from the 2014 vehicle surveys applied to 2014 composition results. See *Special Note Regarding Sector Percentages* on Page 3 for a further explanation of the sector percentage issues.

Ten Most Prevalent Materials

As shown in Table 14, four of the 10 most prevalent materials are compost/mulch materials; they made up about 38 percent of the single-family residential waste stream. *Textiles* and *other miscellaneous paper* were the other commonly recoverable materials and accounted for approximately 9 percent of the waste stream.

Table 14: Ten Most Prevalent Material Types in Single-Family Residential Disposed Waste

Material	Estimated Percent	Cumulative Percent	Estimated Tons
Food	21.0%	21.0%	2,293,394
Remainder/Composite Paper	9.1%	30.1%	998,165
Lumber	7.3%	37.5%	802,320
Remainder/Composite Organic	6.3%	43.7%	685,129
Mixed Residue	5.1%	48.9%	562,072
Leaves and Grass	5.1%	54.0%	561,346
Prunings and Trimmings	4.8%	58.8%	523,588
Textiles	4.8%	63.6%	522,698
Other Miscellaneous Paper	4.3%	67.9%	470,149
Bulky Items	2.7%	70.6%	294,460
Total	70.6%		7,713,321

Any differences between *cumulative percent* figures and the sum of *estimated percent* figures are due to rounding. The above table was constructed using sector percentage data obtained from the 2014 vehicle surveys applied to 2014 composition results. See *Special Note Regarding Sector Percentages* on Page 3 for a further explanation of the sector percentage issues.

As samples were sorted the field crew estimated the proportion of *leaves and grass* that was leaves and the proportion that was grass. There were 90 single-family residential samples containing *leaves and grass*. Data from these samples were used to estimate that leaves were approximately 72 percent, by weight, of the disposed *leaves and grass* in the single-family residential waste stream.

Recoverability

The largest Recoverability Group in the single-family residential waste stream was Compost/Mulch at nearly 45 percent of the waste stream. The Disposed group, the second-largest group by weight, accounted for almost 28 percent of the waste stream. Curbside Recyclables (13 percent), Other Recyclables (11 percent), and Recoverable Inerts (4 percent) accounted for the remainder. Composition estimates by Recoverability Group for the single-family residential waste stream are illustrated in Figure 12.

Figure 12: Recoverability of Single-Family Residential Disposed Waste

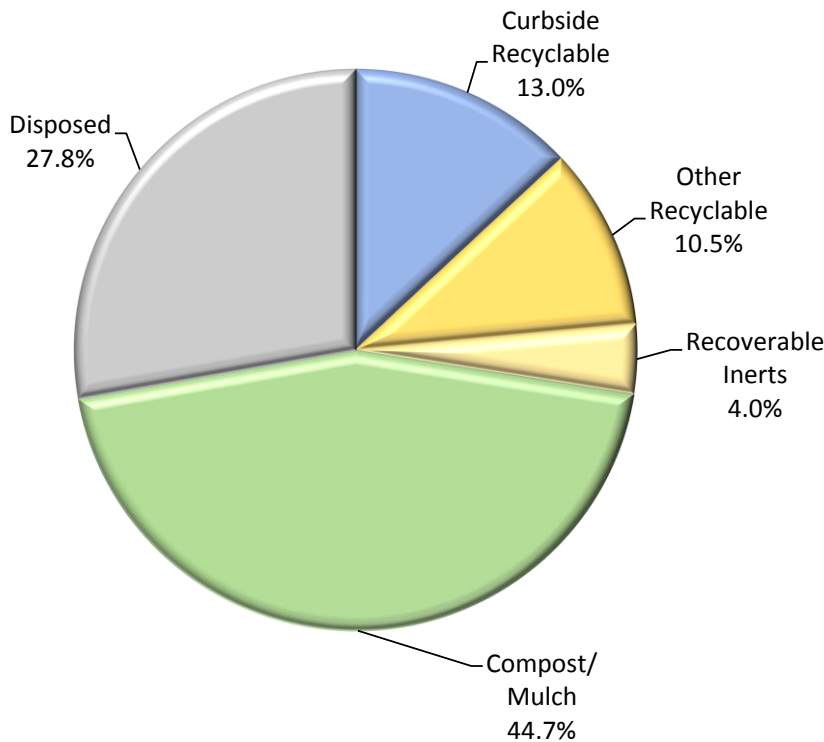

Recoverability Group	Est. Percent
Curbside Recyclable	13.0%
Other Recyclable	10.5%
Recoverable Inerts	4.0%
Compost/Mulch	44.7%
Disposed	27.8%
Total	100%

Numbers may not total exactly due to rounding. See Appendix B: List and Definitions of Material Types for listing of material types in each group.

The above pie chart and table were constructed using sector percentage data obtained from the 2014 vehicle surveys applied to 2014 composition results. See *Special Note Regarding Sector Percentages* on Page 3 for a further explanation of the sector percentage issues.

Detailed Composition

Table 15 presents the detailed composition results for the single-family residential subsector. Table 15 presents the 2014 sector percentages applied to the 2014 waste composition data and, for comparison, the sector percentages obtained in the 2008 Statewide Waste Characterization Study applied to the 2014 waste composition data. When comparing compositions from the two sets of data, composition percentages for most materials may be similar, but tonnage amounts can be very different. See *Special Note Regarding Sector Percentages* on Page 3 for a further explanation of the sector percentage issues.

Table 15: Composition of Single-Family Residential Disposed Waste

Material	Est. Using 2014 Sector Percentages			Est. Using 2008 Sector Percentages		
	Estimated Percent	+ / -	Estimated Tons	Estimated Percent	+ / -	Estimated Tons
Paper	17.7%		1,928,489	18.2%		1,214,855
Uncoated Corrugated Cardboard	1.4%	0.4%	157,394	1.5%	0.3%	100,861
Paper Bags	0.2%	0.0%	24,533	0.3%	0.0%	17,223
Newspaper	1.2%	0.2%	127,089	1.1%	0.2%	73,948
White Ledger Paper	0.2%	0.1%	22,491	0.2%	0.1%	13,230
Other Office Paper	0.4%	0.2%	46,367	0.4%	0.1%	26,634
Magazines and Catalogs	0.7%	0.2%	76,772	0.7%	0.2%	47,817
Phone Books and Directories	0.1%	0.0%	5,530	0.1%	0.0%	3,392
Other Miscellaneous Paper	4.3%	0.5%	470,149	4.4%	0.4%	290,207
Remainder/Composite Paper	9.1%	0.9%	998,165	9.6%	0.8%	641,544
Glass	1.9%		212,316	2.0%		134,240
Clear Glass Bottles and Containers	1.0%	0.2%	111,017	1.1%	0.2%	71,357
Green Glass Bottles and Containers	0.4%	0.2%	40,359	0.3%	0.1%	22,625
Brown Glass Bottles and Containers	0.4%	0.1%	44,230	0.4%	0.1%	28,361
Other Glass Colored Bottles and Containers	0.0%	0.0%	3,517	0.0%	0.0%	1,856
Flat Glass	0.0%	0.0%	917	0.0%	0.0%	834
Remainder/Composite Glass	0.1%	0.0%	12,276	0.1%	0.0%	9,208
Metal	2.7%		298,761	2.8%		183,303
Tin/Steel Cans	0.8%	0.1%	88,403	0.9%	0.1%	56,923
Major Appliances	0.3%	0.5%	34,494	0.2%	0.3%	13,940
Used Oil Filters	0.0%	0.0%	551	0.0%	0.0%	265
Other Ferrous	0.6%	0.2%	64,983	0.6%	0.2%	41,195
Aluminum Cans	0.2%	0.0%	20,641	0.2%	0.1%	14,203
Other Non-Ferrous	0.4%	0.1%	38,313	0.3%	0.1%	22,966
Remainder/Composite Metal	0.5%	0.2%	51,375	0.5%	0.2%	33,811
Electronics	1.0%		111,965	1.1%		70,443
Brown Goods	0.2%	0.4%	25,046	0.2%	0.2%	10,900
Computer-related Electronics	0.2%	0.1%	18,192	0.2%	0.2%	11,696
Other Small Consumer Electronics	0.4%	0.2%	46,572	0.5%	0.2%	30,125
Video Display Devices	0.2%	0.2%	22,155	0.3%	0.3%	17,722
Plastic	10.0%		1,088,970	10.4%		694,687
PETE Containers	0.7%	0.1%	75,859	0.7%	0.1%	47,976
HDPE Containers	0.5%	0.1%	54,177	0.5%	0.1%	35,444
Miscellaneous Plastic Containers	0.6%	0.1%	69,015	0.7%	0.1%	45,821
Plastic Trash Bags	1.2%	0.1%	130,853	1.3%	0.1%	87,456
Plastic Grocery and Other Merchandise Bags	0.8%	0.1%	83,057	0.8%	0.1%	53,257
Non-Bag Commercial and Industrial Packaging Film	0.1%	0.0%	12,857	0.1%	0.0%	9,021
Film Products	0.0%	0.1%	4,991	0.1%	0.1%	4,342
Other Film	1.9%	0.2%	205,827	2.1%	0.2%	139,252
Durable Plastic Items	2.0%	0.6%	215,782	1.8%	0.5%	122,933
Remainder/Composite Plastic	2.2%	0.3%	236,553	2.2%	0.2%	149,186

Confidence intervals calculated at the 90% confidence level. Percentages for material types may not total 100% due to rounding.

More detailed composition tables can be found in Appendix D: Expanded Statewide Waste Characterization Tables

The above table presents the 2014 sector percentages applied to the 2014 waste composition data and, for comparison, the sector percentages obtained in the 2008 Statewide Waste Characterization Study applied to the 2014 waste composition data. See *Special Note Regarding Sector Percentages* on Page 3 for a further explanation of the sector percentage issues.

Table 15 (continued): Composition of Single-Family Residential Disposed Waste

Material	Est. Using 2014 Sector Percentages			Est. Using 2008 Sector Percentages		
	Estimated Percent	+ / -	Estimated Tons	Estimated Percent	+ / -	Estimated Tons
Other Organic	45.7%		4,996,637	46.1%		3,067,981
Food	21.0%	2.0%	2,293,394	22.8%	1.8%	1,519,577
Leaves and Grass	5.1%	2.1%	561,346	4.1%	1.5%	271,221
Prunings and Trimmings	4.8%	2.1%	523,588	3.7%	1.4%	245,332
Branches and Stumps	1.9%	1.7%	211,735	1.4%	1.1%	96,134
Manures	0.0%	0.0%	3,164	0.0%	0.0%	3,224
Textiles	4.8%	0.7%	522,698	5.2%	0.7%	345,065
Carpet	1.8%	1.0%	195,583	1.7%	0.9%	115,873
Remainder/Composite Organic	6.3%	0.8%	685,129	7.1%	0.8%	471,555
Inerts and Other	12.3%		1,343,324	10.5%		700,194
Concrete	0.9%	0.6%	100,747	0.8%	0.4%	53,079
Asphalt Paving	0.0%	0.0%	0	0.0%	0.0%	0
Asphalt Roofing	0.6%	0.7%	65,708	0.4%	0.5%	29,727
Lumber	7.3%	3.4%	802,320	6.2%	2.4%	416,373
Gypsum Board	0.2%	0.2%	26,044	0.2%	0.1%	16,262
Rock, Soil and Fines	2.3%	0.9%	246,993	1.9%	0.6%	124,576
Remainder/Composite Inerts and Other	0.9%	0.5%	101,512	0.9%	0.4%	60,177
Household Hazardous Waste (HHW)	0.6%		63,355	0.5%		34,554
Paint	0.2%	0.3%	25,861	0.2%	0.2%	10,677
Vehicle & Equipment Fluids	0.0%	0.0%	219	0.0%	0.0%	88
Used Oil	0.0%	0.0%	711	0.0%	0.0%	287
Batteries	0.1%	0.0%	7,317	0.1%	0.0%	5,988
Remainder/Composite Household Hazardous	0.3%	0.2%	29,247	0.3%	0.2%	17,514
Special Waste	2.9%		318,424	2.8%		186,387
Ash	0.0%	0.0%	1,502	0.0%	0.0%	788
Treated Medical Waste	0.0%	0.0%	0	0.0%	0.0%	0
Bulky Items	2.7%	2.3%	294,460	2.5%	1.8%	166,726
Tires	0.1%	0.2%	11,368	0.1%	0.2%	9,533
Remainder/Composite Special Waste	0.1%	0.1%	11,094	0.1%	0.1%	9,341
Mixed Residue	5.1%		562,072	5.6%		375,541
Totals	100.0%		10,924,313	100.0%		6,662,188
Sample Count	201			201		

Confidence intervals calculated at the 90% confidence level. Percentages for material types may not total 100% due to rounding.

More detailed composition tables can be found in Appendix D: Expanded Statewide Waste Characterization Tables

The above table presents the 2014 sector percentages applied to the 2014 waste composition data and, for comparison, the sector percentages obtained in the 2008 Statewide Waste Characterization Study applied to the 2014 waste composition data. See *Special Note Regarding Sector Percentages* on Page 3 for a further explanation of the sector percentage issues.

Multi-Family Residential Waste

The objective of this section is to present the characterization data for California's multi-family residential waste stream at the state level. This subsector includes waste that is collected by haulers from apartments or condominiums. Since multi-family waste is often collected with commercial waste, samples from the multi-family residential sector were collected from dumpsters at apartment buildings and complexes rather than at solid waste facilities in order to get pure samples.

Overview and Analysis

For the first two seasons, samples of multi-family residential waste were obtained from apartment complexes that were selected randomly from the area surrounding the solid waste facilities that participated in the study. For the third and fourth seasons, samples of multi-family residential waste were obtained from apartment complexes that were selected randomly from the area surrounding the solid waste facilities participating in a separate CalRecycle study. See Appendix A: Detailed Methodology for a list of facilities in this task. Fifty-two samples of multi-family waste were collected in the five regions of the state.

Table 16 presents the numbers of samples that were obtained in each region and each season.

Table 16: Multi-Family Residential Samples Obtained, by Region and Season

Season	Bay Area	Coastal	Mountain	Southern	Valley	Totals
Winter 2014	3	2	3	2	2	12
Spring 2014	2	3	2	3	3	13
Summer 2014	6	3	3	4	3	19
Fall 2014	1	2	2	1	2	8
Totals	12	10	10	10	10	52

Composition results by **Material Class** for multi-family residential waste are illustrated in Figure 13 and described in detail in Table 18. As shown in Figure 13, the largest **Material Class** was **Other Organic**, which accounted for about 44 percent of the material in the waste stream, followed by **Paper**, which made up about 24 percent of the multi-family residential waste stream by weight.

Figure 13: Overview of Multi-Family Residential Disposed Waste

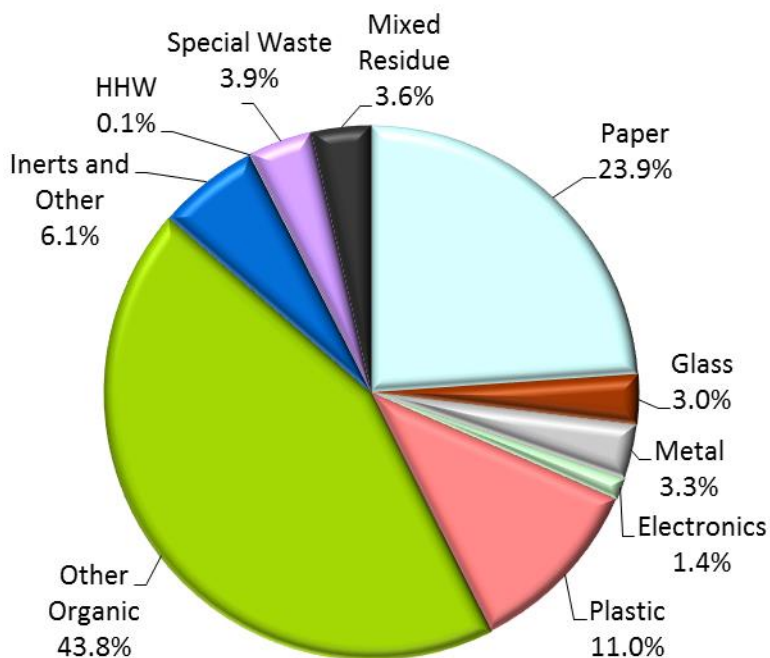

Material Class	Est. Percent
Paper	23.9%
Glass	3.0%
Metal	3.3%
Electronics	1.4%
Plastic	11.0%
Other Organic	43.8%
Inerts and Other	6.1%
HHW	0.1%
Special Waste	3.9%
Mixed Residue	3.6%
Total	100%

Numbers may not total exactly due to rounding.

The above pie chart and table were constructed using sector percentage data obtained from the 2014 vehicle surveys applied to 2014 composition results. See *Special Note Regarding Sector Percentages* on Page 3 for a further explanation of the sector percentage issues.

Ten Most Prevalent Materials

As shown in Table 17, *food* was the most prevalent *material type*, accounting for almost 25 percent of multi-family residential waste. Typically recoverable *material types*, including *textiles*, *other miscellaneous paper*, *newspaper*, and *uncoated corrugated cardboard*, comprised a little more than 21 percent of the total.

Table 17: Ten Most Prevalent Material Types in Multi-Family Residential Disposed Waste

Material	Estimated Percent	Cumulative Percent	Estimated Tons
Food	24.7%	24.7%	888,327
Remainder/Composite Paper	7.9%	32.6%	282,952
Textiles	7.6%	40.2%	273,436
Remainder/Composite Organic	7.1%	47.3%	255,169
Other Miscellaneous Paper	5.1%	52.4%	182,032
Newspaper	5.0%	57.4%	179,291
Lumber	5.0%	62.3%	178,157
Uncoated Corrugated Cardboard	3.6%	65.9%	129,166
Mixed Residue	3.6%	69.5%	128,869
Remainder/Composite Plastic	3.5%	73.0%	124,486
Total	73.0%		2,621,886

Any differences between *cumulative percent* figures and the sum of *estimated percent* figures are due to rounding. The above table was constructed using sector percentage data obtained from the 2014 vehicle surveys applied to 2014 composition results. See *Special Note Regarding Sector Percentages* on Page 3 for a further explanation of the sector percentage issues.

Recoverability

Composition estimates by Recoverability Group for the multi-family residential waste stream are illustrated in Figure 14. The two largest Recoverability Groups were Compost/Mulch and Disposed, which, by weight, accounted for 38 percent and 27 percent of the waste stream, respectively.

Figure 14: Recoverability of Multi-Family Residential Disposed Waste

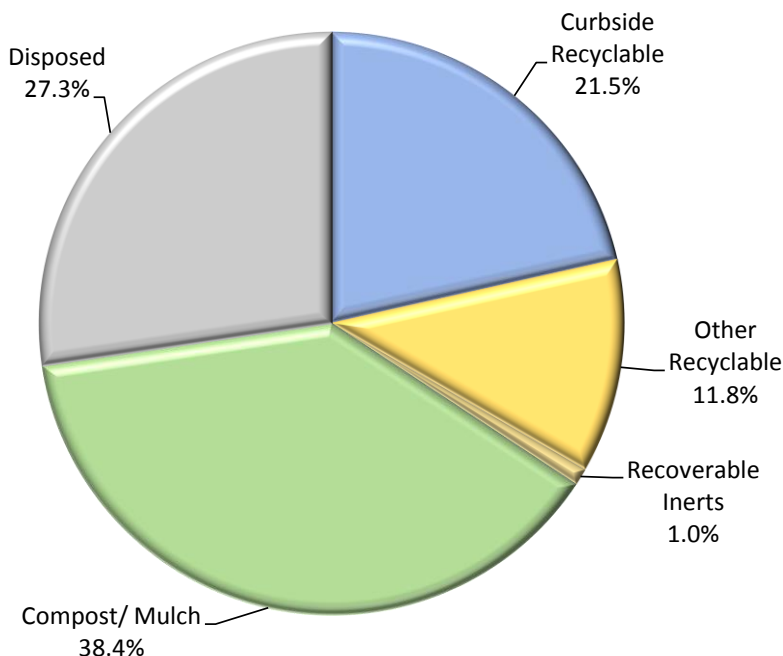

Recoverability Group	Est. Percent
Curbside Recyclable	21.5%
Other Recyclable	11.8%
Recoverable Inerts	1.0%
Compost/Mulch	38.4%
Disposed	27.3%
Total	100%

Numbers may not total exactly due to rounding. See Appendix B: List and Definitions of Material Types for listing of material types in each group.

The above pie chart and table were constructed using sector percentage data obtained from the 2014 vehicle surveys applied to 2014 composition results. See *Special Note Regarding Sector Percentages* on Page 3 for a further explanation of the sector percentage issues.

Detailed Composition

Table 18 presents the detailed composition results for the multi-family residential subsector. Table 18 presents the 2014 sector percentages applied to the 2014 waste composition data and, for comparison, the sector percentages obtained in the 2008 Statewide Waste Characterization Study applied to the 2014 waste composition data. When comparing compositions from the two sets of data, composition percentages for most materials may be similar, but tonnage amounts can be very different. See *Special Note Regarding Sector Percentages* on Page 3 for a further explanation of the sector percentage issues.

Table 18: Composition of Multi-Family Residential Disposed Waste

Material	Est. Using 2014 Sector Percentages			Est. Using 2008 Sector Percentages		
	Estimated Percent	+ / -	Estimated Tons	Estimated Percent	+ / -	Estimated Tons
Paper	23.9%		858,806	24.3%		629,829
Uncoated Corrugated Cardboard	3.6%	1.6%	129,166	3.6%	1.7%	92,209
Paper Bags	0.6%	0.1%	20,110	0.6%	0.1%	14,957
Newspaper	5.0%	3.7%	179,291	5.2%	3.9%	135,144
White Ledger Paper	0.5%	0.4%	18,173	0.5%	0.4%	13,735
Other Office Paper	0.5%	0.3%	19,476	0.5%	0.3%	14,066
Magazines and Catalogs	0.7%	0.3%	26,742	0.8%	0.3%	19,791
Phone Books and Directories	0.0%	0.0%	864	0.0%	0.0%	519
Other Miscellaneous Paper	5.1%	1.1%	182,032	5.1%	1.2%	132,177
Remainder/Composite Paper	7.9%	1.7%	282,952	8.0%	1.8%	207,232
Glass	3.0%		108,394	3.0%		77,859
Clear Glass Bottles and Containers	1.6%	0.5%	58,393	1.6%	0.5%	42,421
Green Glass Bottles and Containers	0.1%	0.1%	4,631	0.1%	0.1%	3,358
Brown Glass Bottles and Containers	0.7%	0.5%	24,627	0.7%	0.6%	18,305
Other Glass Colored Bottles and Containers	0.1%	0.1%	2,462	0.1%	0.1%	1,895
Flat Glass	0.0%	0.1%	1,510	0.0%	0.1%	1,229
Remainder/Composite Glass	0.5%	0.3%	16,772	0.4%	0.3%	10,651
Metal	3.3%		117,094	2.9%		75,273
Tin/Steel Cans	0.9%	0.3%	33,542	0.9%	0.3%	24,309
Major Appliances	0.0%	0.0%	3	0.0%	0.0%	1
Used Oil Filters	0.0%	0.0%	0	0.0%	0.0%	0
Other Ferrous	0.7%	0.5%	24,133	0.5%	0.4%	12,908
Aluminum Cans	0.2%	0.1%	8,368	0.2%	0.1%	6,122
Other Non-Ferrous	0.7%	0.6%	26,691	0.6%	0.5%	16,406
Remainder/Composite Metal	0.7%	0.2%	24,358	0.6%	0.2%	15,527
Electronics	1.4%		48,820	1.3%		34,363
Brown Goods	0.5%	0.6%	16,310	0.5%	0.6%	12,150
Computer-related Electronics	0.2%	0.2%	6,708	0.2%	0.2%	5,350
Other Small Consumer Electronics	0.2%	0.2%	8,508	0.3%	0.2%	6,714
Video Display Devices	0.5%	0.5%	17,294	0.4%	0.4%	10,148
Plastic	11.0%		396,077	11.1%		287,902
PETE Containers	1.0%	0.3%	34,626	1.0%	0.3%	25,422
HDPE Containers	0.4%	0.1%	15,825	0.4%	0.1%	11,110
Miscellaneous Plastic Containers	0.6%	0.3%	23,232	0.7%	0.3%	17,198
Plastic Trash Bags	1.1%	0.3%	40,025	1.1%	0.3%	28,943
Plastic Grocery and Other Merchandise Bags	0.9%	0.3%	32,296	0.9%	0.3%	23,776
Non-Bag Commercial and Industrial Packaging Film	0.2%	0.3%	6,791	0.2%	0.3%	5,222
Film Products	0.0%	0.0%	65	0.0%	0.0%	50
Other Film	2.2%	0.9%	79,925	2.3%	1.0%	59,092
Durable Plastic Items	1.1%	0.5%	38,806	1.0%	0.5%	25,984
Remainder/Composite Plastic	3.5%	1.0%	124,486	3.5%	1.1%	91,106

Confidence intervals calculated at the 90% confidence level. Percentages for material types may not total 100% due to rounding.

More detailed composition tables can be found in Appendix D: Expanded Statewide Waste Characterization Tables

The above table presents the 2014 sector percentages applied to the 2014 waste composition data and, for comparison, the sector percentages obtained in the 2008 Statewide Waste Characterization Study applied to the 2014 waste composition data. See *Special Note Regarding Sector Percentages* on Page 3 for a further explanation of the sector percentage issues.

Table 18 (continued): Composition of Multi-Family Residential Disposed Waste

Material	Est. Using 2014 Sector Percentages			Est. Using 2008 Sector Percentages		
	Estimated Percent	+ / -	Estimated Tons	Estimated Percent	+ / -	Estimated Tons
Other Organic	43.8%		1,571,832	43.5%		1,127,595
Food	24.7%	3.6%	888,327	24.8%	3.8%	642,265
Leaves and Grass	2.8%	2.1%	102,311	2.8%	2.2%	71,886
Prunings and Trimmings	0.8%	0.8%	29,495	0.8%	0.8%	20,101
Branches and Stumps	0.0%	0.0%	0	0.0%	0.0%	0
Manures	0.0%	0.0%	0	0.0%	0.0%	0
Textiles	7.6%	4.0%	273,436	7.8%	4.2%	201,973
Carpet	0.6%	0.7%	23,094	0.7%	0.7%	17,642
Remainder/Composite Organic	7.1%	2.1%	255,169	6.7%	2.2%	173,727
Inerts and Other	6.1%		220,287	6.2%		159,521
Concrete	0.3%	0.4%	10,237	0.3%	0.4%	7,615
Asphalt Paving	0.0%	0.0%	0	0.0%	0.0%	0
Asphalt Roofing	0.0%	0.0%	0	0.0%	0.0%	0
Lumber	5.0%	4.5%	178,157	5.0%	4.8%	129,343
Gypsum Board	0.4%	0.4%	14,751	0.4%	0.4%	10,499
Rock, Soil and Fines	0.3%	0.2%	9,409	0.3%	0.2%	6,498
Remainder/Composite Inerts and Other	0.2%	0.2%	7,734	0.2%	0.2%	5,567
Household Hazardous Waste (HHW)	0.1%		2,814	0.1%		2,042
Paint	0.0%	0.0%	24	0.0%	0.0%	9
Vehicle & Equipment Fluids	0.0%	0.0%	0	0.0%	0.0%	0
Used Oil	0.0%	0.0%	0	0.0%	0.0%	0
Batteries	0.0%	0.0%	1,183	0.0%	0.0%	839
Remainder/Composite Household Hazardous	0.0%	0.0%	1,607	0.0%	0.0%	1,194
Special Waste	3.9%		138,906	3.9%		101,750
Ash	0.1%	0.1%	2,442	0.1%	0.1%	2,050
Treated Medical Waste	0.8%	1.3%	29,791	0.9%	1.4%	22,977
Bulky Items	2.9%	3.1%	105,915	2.9%	3.3%	76,181
Tires	0.0%	0.0%	0	0.0%	0.0%	0
Remainder/Composite Special Waste	0.0%	0.0%	758	0.0%	0.0%	542
Mixed Residue	3.6%		128,869	3.7%		95,681
Totals	100.0%		3,591,900	100.0%		2,591,814
Sample Count	52			52		

Confidence intervals calculated at the 90% confidence level. Percentages for material types may not total 100% due to rounding.

More detailed composition tables can be found in Appendix D: Expanded Statewide Waste Characterization Tables

The above table presents the 2014 sector percentages applied to the 2014 waste composition data and, for comparison, the sector percentages obtained in the 2008 Statewide Waste Characterization Study applied to the 2014 waste composition data. See *Special Note Regarding Sector Percentages* on Page 3 for a further explanation of the sector percentage issues.

Self-Hauled Waste

The objective of this section is to present the characterization data for California's self-hauled waste stream at the state level. Self-hauled waste is waste that is transported to the solid waste disposal site by someone other than a contracted or franchised hauler. This section presents composition findings for the statewide self-hauled sector as a whole, followed by findings for commercial self-hauled waste and residential self-hauled waste.

Overview and Analysis

Since tonnage amounts for the residential and other sectors were very different from past studies, sector percentages and compositions were calculated using both 2014 and 2008 vehicle survey data. See Special Note Regarding Sector Percentages for further explanation of sector percentage issues.

As shown in Table 4 the self-hauled waste sector accounts for approximately 14 percent and 20 percent of California's municipal solid waste stream using 2014 and 2008 sector percentages, respectively. Based on the 2014 estimated sector percentages, the commercial self-hauled and residential self-hauled subsectors make up approximately 11 percent and 3 percent, respectively. Based on the 2008 estimated sector percentages, commercial self-hauled and residential self-hauled proportions change to 17 percent and three percent, respectively.

Samples of self-hauled waste were obtained from randomly selected vehicles at the landfills and transfer stations visited in this study. Overall self-hauled composition results are based on the commercial and residential subsectors, weighted at the regional level. See Appendix A: Detailed Methodology for a description of the methods used in selecting, sorting, and analyzing samples.

Table 19 presents the numbers of samples that were obtained in each region and each season. Overall, 250 samples of self-hauled waste were sorted.

Table 19: Self-Hauled Samples Obtained by Region and Season

Season	Bay Area	Coastal	Mountain	Southern	Valley	Totals
Winter 2014	15	11	15	10	10	61
Spring 2014	10	17	10	15	15	67
Summer 2014	9	12	13	9	9	52
Fall 2014	16	10	12	16	16	70
Totals	50	50	50	50	50	250

See Appendix A: Detailed Methodology for the names and locations of the solid waste facilities that were visited.

The estimated quantity of construction debris disposed by each of the self-hauled subsectors is summarized in Table 20. Results indicate that an estimated 40 percent of the self-hauled disposed waste comes from C&D activities; the proportion is higher for the commercial self-hauled subsector (45 percent) and lower for the residential self-hauled subsector (23 percent). This material is primarily delivered to the facilities in pick-up trucks, trailers, and other modified work vehicles.

Table 20: Estimated Quantities of Construction Debris, by Self-Hauled Subsector

Activity Type	Commercial Self-Hauled		Residential Self-Hauled		Self-Hauled Total	
	Est. Using 2014 Sector %	Est. Using 2008 Sector %	Est. Using 2014 Sector %	Est. Using 2008 Sector %	Est. Using 2014 Sector %	Est. Using 2008 Sector %
New Construction	369,399	402,246	21,127	3,583	390,526	405,829
Remodeling	439,713	689,081	90,978	72,480	530,691	761,561
Demolition	591,940	1,048,383	97,638	30,919	689,578	1,079,302
Roofing	155,160	552,510	4,865	11,843	160,025	564,353
C&D Subtotal Tons	1,556,211	2,692,218	214,608	118,826	1,770,820	2,811,044
C&D Subtotal Percent	44.6%	50.9%	22.5%	11.6%	39.9%	44.6%
Landscaping	232,164	185,032	25,055	5,589	257,219	190,622
Other Waste	1,697,922	2,408,496	712,169	898,624	2,410,091	3,307,120
Other Subtotal	1,930,085	2,593,528	737,224	904,213	2,667,310	3,497,741
Total	3,486,297	5,285,747	951,833	1,023,039	4,438,130	6,308,785

Numbers may not total exactly due to rounding. Source: 2014 vehicle survey findings and 2008 vehicle survey findings applied to individual facility records and CalRecycle Disposal Reporting System 2013 tonnage figures. See *Special Note Regarding Sector Percentages* on Page 3 for further explanation of sector percentage issues.

Composition results by **Material Class** for self-hauled waste are illustrated in Figure 15 and described in detail in Table 22. More than half of the overall self-hauled waste stream—approximately 55 percent—was made up of the class **Inerts and Other**.

Figure 15: Overview of Overall Self-Hauled Disposed Waste

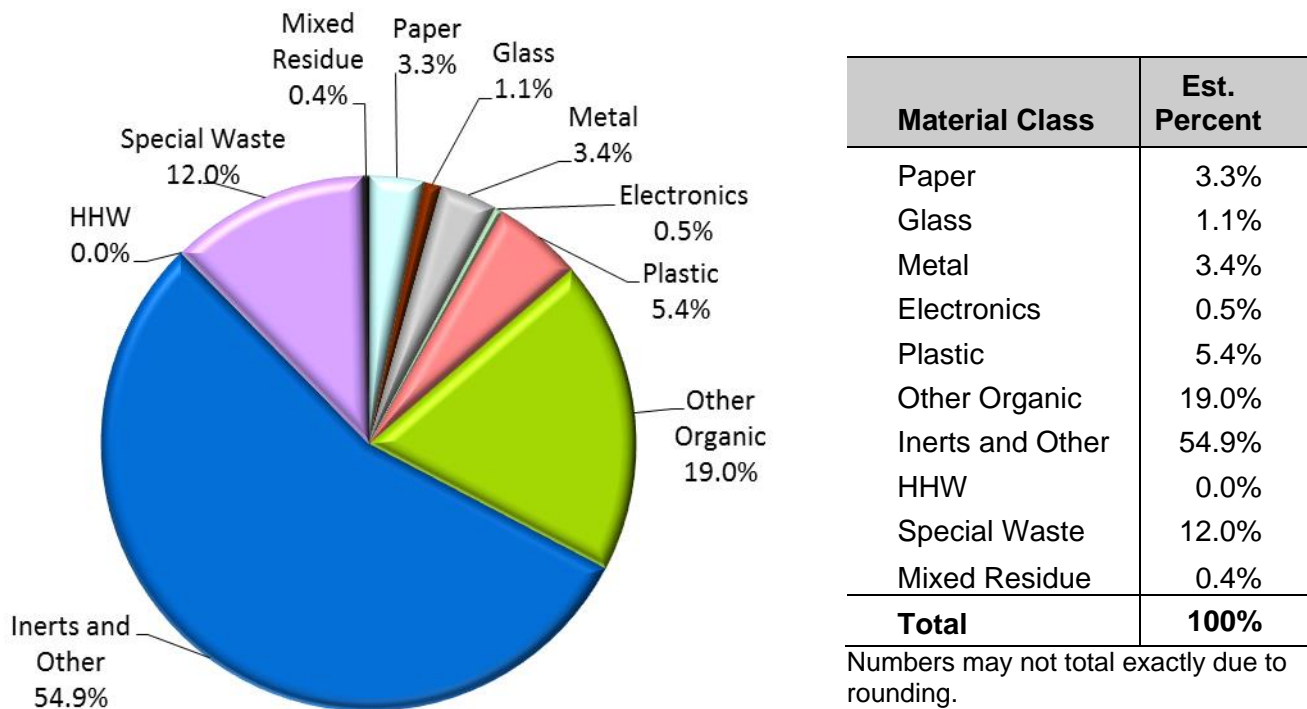

The above pie chart and table were constructed using sector percentage data obtained from the 2014 vehicle surveys applied to 2014 composition results. See *Special Note Regarding Sector Percentages* on Page 3 for a further explanation of the sector percentage issues.

Ten Most Prevalent Materials

Lumber was the most prevalent material in this stream, accounting for an estimated 28 percent of the overall self-hauled waste stream. Compost/mulch materials accounted for about 36 percent of disposed materials. Other recoverable *material types* included *rock, soil and fines, carpet, gypsum board, and concrete*, as shown in Table 21. These materials accounted for 19 percent of self-hauled waste.

Table 21: Ten Most Prevalent Material Types in Overall Self-Hauled Disposed Waste

Material	Estimated Percent	Cumulative Percent	Estimated Tons
Lumber	28.3%	28.3%	1,256,403
Bulky Items	11.4%	39.7%	507,514
Remainder/Composite Inerts and Other	9.2%	49.0%	409,945
Rock, Soil and Fines	5.9%	54.9%	263,447
Carpet	5.3%	60.2%	235,989
Prunings and Trimmings	4.5%	64.7%	197,929
Gypsum Board	4.3%	69.0%	192,185
Concrete	3.9%	72.9%	171,032
Leaves and Grass	3.0%	75.8%	131,527
Remainder/Composite Plastic	2.5%	78.3%	110,105
Total	78.3%		3,476,076

Any differences between *cumulative percent* figures and the sum of *estimated percent* figures are due to rounding. The above table was constructed using sector percentage data obtained from the 2014 vehicle surveys applied to 2014 composition results. See *Special Note Regarding Sector Percentages* on Page 3 for a further explanation of the sector percentage issues.

As samples were sorted the field crew estimated the proportion of *leaves and grass* that was leaves and the proportion that was grass. Thirty self-hauled samples contained *leaves and grass*. Data from these samples were used to estimate that leaves were approximately 64 percent, by weight, of the disposed *leaves and grass* in the self-hauled waste stream.

Recoverability

Composition estimates by Recoverability Group for the overall self-hauled waste stream are illustrated in Figure 16. The Disposed group accounted for 45 percent of the waste stream. Compost/Mulch materials (25 percent) were the majority of the remaining materials.

Figure 16: Recoverability of Overall Self-Hauled Disposed Waste

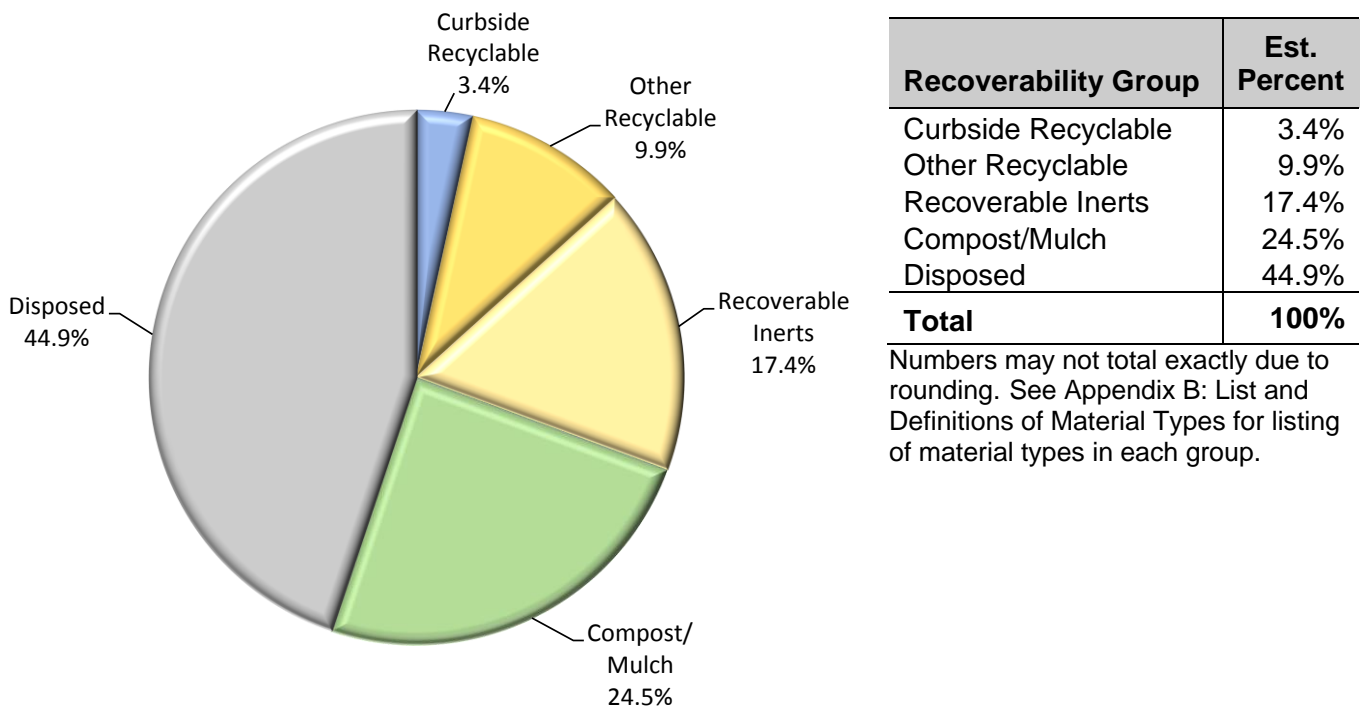

The above pie chart and table were constructed using sector percentage data obtained from the 2014 vehicle surveys applied to 2014 composition results. See *Special Note Regarding Sector Percentages* on Page 3 for a further explanation of the sector percentage issues.

Detailed Composition

Table 22 presents the detailed composition results for the overall self-hauled sector. Table 22 presents the 2014 sector percentages applied to the 2014 waste composition data and, for comparison, the sector percentages obtained in the 2008 Statewide Waste Characterization Study applied to the 2014 waste composition data. When comparing compositions from the two sets of data, composition percentages for most materials may be similar, but tonnage amounts can be very different. See *Special Note Regarding Sector Percentages* on Page 3 for a further explanation of the sector percentage issues.

Table 22: Composition of Overall Self-Hauled Disposed Waste

Material	Est. Using 2014 Sector Percentages			Est. Using 2008 Sector Percentages		
	Estimated Percent	+ / -	Estimated Tons	Estimated Percent	+ / -	Estimated Tons
Paper	3.3%		146,520	3.3%		206,490
Uncoated Corrugated Cardboard	1.9%	0.9%	84,253	2.0%	1.1%	124,666
Paper Bags	0.1%	0.2%	5,683	0.1%	0.1%	5,972
Newspaper	0.0%	0.0%	1,587	0.0%	0.0%	2,261
White Ledger Paper	0.0%	0.0%	1,973	0.0%	0.0%	2,074
Other Office Paper	0.0%	0.0%	1,222	0.0%	0.0%	1,253
Magazines and Catalogs	0.1%	0.1%	4,497	0.1%	0.1%	4,880
Phone Books and Directories	0.1%	0.1%	2,845	0.1%	0.1%	3,696
Other Miscellaneous Paper	0.6%	0.4%	24,921	0.6%	0.5%	36,592
Remainder/Composite Paper	0.4%	0.2%	19,539	0.4%	0.2%	25,097
Glass	1.1%		46,686	0.8%		53,618
Clear Glass Bottles and Containers	0.1%	0.1%	4,741	0.1%	0.0%	5,602
Green Glass Bottles and Containers	0.0%	0.0%	655	0.0%	0.0%	769
Brown Glass Bottles and Containers	0.1%	0.1%	2,656	0.0%	0.0%	2,901
Other Glass Colored Bottles and Containers	0.0%	0.0%	57	0.0%	0.0%	61
Flat Glass	0.5%	0.3%	22,303	0.4%	0.2%	23,928
Remainder/Composite Glass	0.4%	0.2%	16,275	0.3%	0.2%	20,357
Metal	3.4%		152,581	3.1%		196,284
Tin/Steel Cans	0.2%	0.2%	9,874	0.2%	0.2%	10,405
Major Appliances	0.1%	0.1%	4,175	0.1%	0.1%	5,126
Used Oil Filters	0.0%	0.0%	133	0.0%	0.0%	303
Other Ferrous	1.0%	0.4%	43,427	0.9%	0.4%	54,371
Aluminum Cans	0.0%	0.0%	375	0.0%	0.0%	484
Other Non-Ferrous	0.5%	0.4%	21,643	0.6%	0.5%	34,951
Remainder/Composite Metal	1.6%	0.7%	72,955	1.4%	0.6%	90,642
Electronics	0.5%		22,981	0.4%		27,275
Brown Goods	0.1%	0.1%	3,588	0.1%	0.1%	3,777
Computer-related Electronics	0.2%	0.2%	8,444	0.1%	0.2%	8,548
Other Small Consumer Electronics	0.1%	0.1%	5,854	0.1%	0.2%	8,938
Video Display Devices	0.1%	0.2%	5,095	0.1%	0.1%	6,010
Plastic	5.4%		239,437	4.9%		309,812
PETE Containers	0.1%	0.1%	4,351	0.1%	0.1%	4,827
HDPE Containers	0.0%	0.0%	837	0.0%	0.0%	1,090
Miscellaneous Plastic Containers	0.0%	0.0%	827	0.0%	0.0%	949
Plastic Trash Bags	0.1%	0.0%	3,851	0.1%	0.1%	5,565
Plastic Grocery and Other Merchandise Bags	0.0%	0.0%	842	0.0%	0.0%	953
Non-Bag Commercial and Industrial Packaging Film	0.1%	0.1%	3,395	0.1%	0.1%	3,687
Film Products	0.2%	0.3%	8,346	0.2%	0.4%	14,720
Other Film	0.1%	0.1%	6,156	0.1%	0.1%	8,051
Durable Plastic Items	2.3%	1.2%	100,726	1.9%	1.0%	120,206
Remainder/Composite Plastic	2.5%	1.5%	110,105	2.4%	1.6%	149,764

Confidence intervals calculated at the 90% confidence level. Percentages for material types may not total 100% due to rounding.

More detailed composition tables can be found in Appendix D: Expanded Statewide Waste Characterization Tables

The above table presents the 2014 sector percentages applied to the 2014 waste composition data and, for comparison, the sector percentages obtained in the 2008 Statewide Waste Characterization Study applied to the 2014 waste composition data. See *Special Note Regarding Sector Percentages* on Page 3 for a further explanation of the sector percentage issues.

Table 22 (continued): Composition of Overall Self-Hauled Disposed Waste

Material	Est. Using 2014 Sector Percentages			Est. Using 2008 Sector Percentages		
	Estimated Percent	+ / -	Estimated Tons	Estimated Percent	+ / -	Estimated Tons
Other Organic	19.0%		843,874	20.4%		1,289,332
Food	0.4%	0.3%	18,535	0.4%	0.2%	23,092
Leaves and Grass	3.0%	2.5%	131,527	3.4%	3.2%	211,664
Prunings and Trimmings	4.5%	2.9%	197,929	5.3%	3.8%	336,242
Branches and Stumps	2.4%	1.8%	108,345	2.8%	2.3%	177,973
Manures	0.5%	0.6%	21,189	0.3%	0.4%	21,230
Textiles	1.6%	0.5%	72,748	1.5%	0.5%	96,290
Carpet	5.3%	2.4%	235,989	5.2%	2.8%	327,354
Remainder/Composite Organic	1.3%	1.0%	57,612	1.5%	1.3%	95,487
Inerts and Other	54.9%		2,436,390	55.3%		3,488,473
Concrete	3.9%	1.9%	171,032	3.8%	2.1%	237,906
Asphalt Paving	1.5%	2.4%	65,490	2.0%	3.2%	123,205
Asphalt Roofing	1.8%	1.3%	77,888	1.5%	1.0%	93,999
Lumber	28.3%	4.4%	1,256,403	27.1%	5.1%	1,709,191
Gypsum Board	4.3%	2.2%	192,185	4.2%	2.4%	265,032
Rock, Soil and Fines	5.9%	3.0%	263,447	6.8%	3.7%	430,638
Remainder/Composite Inerts and Other	9.2%	3.7%	409,945	10.0%	4.6%	628,504
Household Hazardous Waste (HHW)	0.0%		1,684	0.0%		1,980
Paint	0.0%	0.0%	79	0.0%	0.0%	81
Vehicle & Equipment Fluids	0.0%	0.0%	0	0.0%	0.0%	0
Used Oil	0.0%	0.0%	38	0.0%	0.0%	87
Batteries	0.0%	0.0%	257	0.0%	0.0%	345
Remainder/Composite Household Hazardous	0.0%	0.0%	1,310	0.0%	0.0%	1,468
Special Waste	12.0%		532,145	11.4%		718,568
Ash	0.0%	0.0%	787	0.0%	0.0%	817
Treated Medical Waste	0.0%	0.0%	0	0.0%	0.0%	0
Bulky Items	11.4%	3.6%	507,514	11.0%	4.2%	693,930
Tires	0.5%	0.8%	23,787	0.4%	0.6%	23,749
Remainder/Composite Special Waste	0.0%	0.0%	57	0.0%	0.0%	72
Mixed Residue	0.4%		15,832	0.3%		16,953
Totals	100.0%		4,438,130	100.0%		6,308,785
Sample Count	250			250		

Confidence intervals calculated at the 90% confidence level. Percentages for material types may not total 100% due to rounding.

More detailed composition tables can be found in Appendix D: Expanded Statewide Waste Characterization Tables

The above table presents the 2014 sector percentages applied to the 2014 waste composition data and, for comparison, the sector percentages obtained in the 2008 Statewide Waste Characterization Study applied to the 2014 waste composition data. See *Special Note Regarding Sector Percentages* on Page 3 for a further explanation of the sector percentage issues.

Commercial Self-Hauled Waste

The objective of this section is to present the characterization data for California's commercial self-hauled waste stream at the state level. This sector includes waste hauled to a solid waste disposal site by a commercial enterprise, such as a landscaper or contractor, even if the source of waste was residential dwellings.

Overview and Analysis

Samples of commercial self-hauled waste were obtained from randomly selected vehicles at the landfills and transfer stations visited in this study.

In total, 134 samples of commercial self-hauled waste were sorted. See Appendix A: Detailed Methodology for a description of the methods used in selecting, sorting, and analyzing samples. Table 23 presents the numbers of samples that were obtained in each region and each season.

Table 23: Commercial Self-Hauled Samples Obtained, by Region and Season

Season	Bay Area	Coastal	Mountain	Southern	Valley	Totals
Winter 2014	8	4	4	4	6	26
Spring 2014	4	7	1	10	11	33
Summer 2014	6	10	9	5	5	35
Fall 2014	6	8	5	12	9	40
Totals	24	29	19	31	31	134

See Appendix A: Detailed Methodology for the names and locations of the solid waste facilities that were visited.

Composition results by **Material Class** for commercial self-hauled waste are illustrated in Figure 17 and described in detail in Table 25. An estimated 56 percent of the commercial self-hauled waste stream was made up of the class **Inerts and Other**. **Other Organic** made up the next largest **Material Class**, with an estimated 20 percent of material.

Figure 17: Overview of Commercial Self-Hauled Disposed Waste

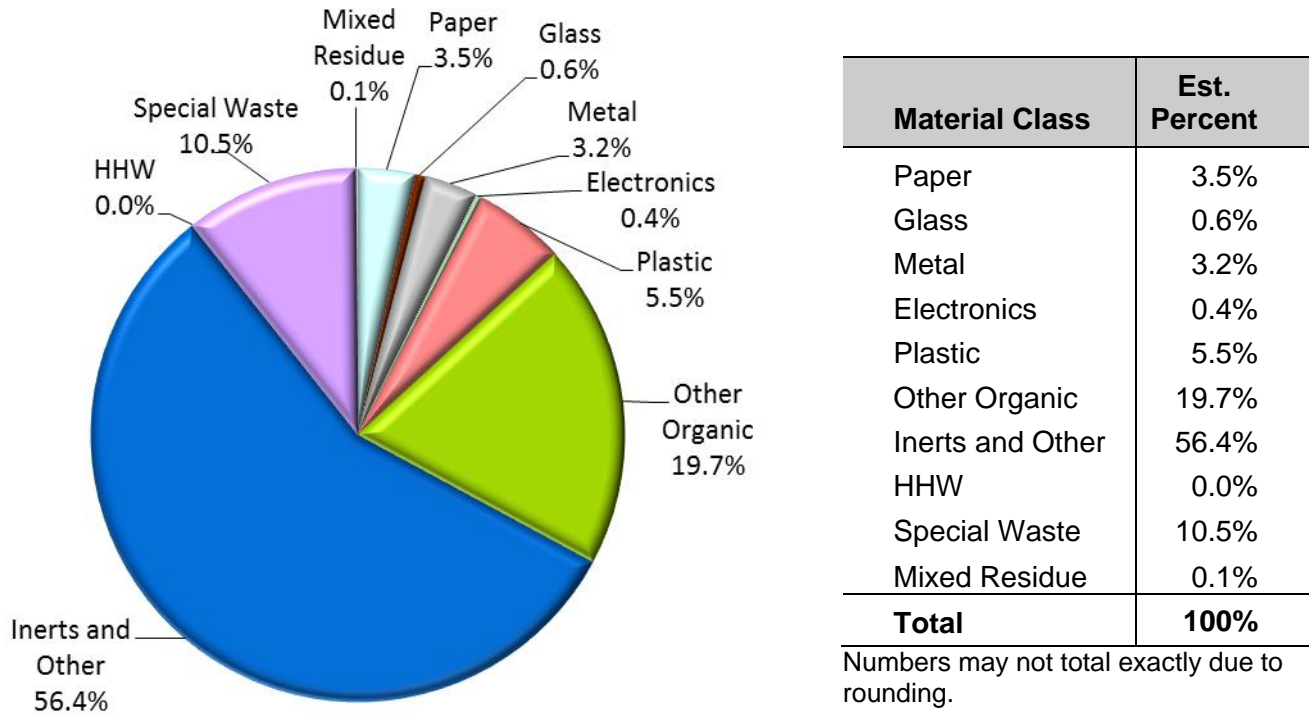

The above pie chart and table were constructed using sector percentage data obtained from the 2014 vehicle surveys applied to 2014 composition results. See *Special Note Regarding Sector Percentages* on Page 3 for a further explanation of the sector percentage issues.

Ten Most Prevalent Materials

Table 24 shows the 10 most prevalent *material types* by weight in the commercial self-hauled waste stream. *Rocks, soil and fines, carpet, gypsum board, and concrete* are recoverable and, together, accounted for about 21 percent of this waste stream. Compost/mulch materials made up 35 percent of commercial self-hauled materials.

Table 24: Ten Most Prevalent Material Types in Commercial Self-Hauled Disposed Waste

Material	Estimated Percent	Cumulative Percent	Estimated Tons
Lumber	26.9%	26.9%	938,070
Remainder/Composite Inerts and Other	10.5%	37.4%	365,796
Bulky Items	9.9%	47.3%	344,809
Rock, Soil and Fines	6.9%	54.2%	241,201
Carpet	5.7%	59.9%	199,030
Prunings and Trimmings	5.1%	65.0%	178,039
Gypsum Board	4.3%	69.3%	148,294
Concrete	3.8%	73.1%	133,417
Leaves and Grass	3.0%	76.1%	105,942
Remainder/Composite Plastic	2.6%	78.8%	91,864
Total	78.8%		2,746,463

Any differences between *cumulative percent* figures and the sum of *estimated percent* figures are due to rounding. The above table was constructed using sector percentage data obtained from the 2014 vehicle surveys applied to 2014 composition results. See *Special Note Regarding Sector Percentages* on Page 3 for a further explanation of the sector percentage issues.

Recoverability

As shown in Figure 18, Disposed was the largest Recoverability Group in the commercial self-hauled waste stream. It accounted for about 44 percent of the waste stream by weight. It was followed by Compost/Mulch (24 percent), Recoverable Inerts (19 percent), and Other Recyclable (10 percent). The Curbside Recyclable group was the smallest group, it accounted for 3 percent of the commercial self-hauled waste stream.

Figure 18: Recoverability of Commercial Self-Hauled Disposed Waste

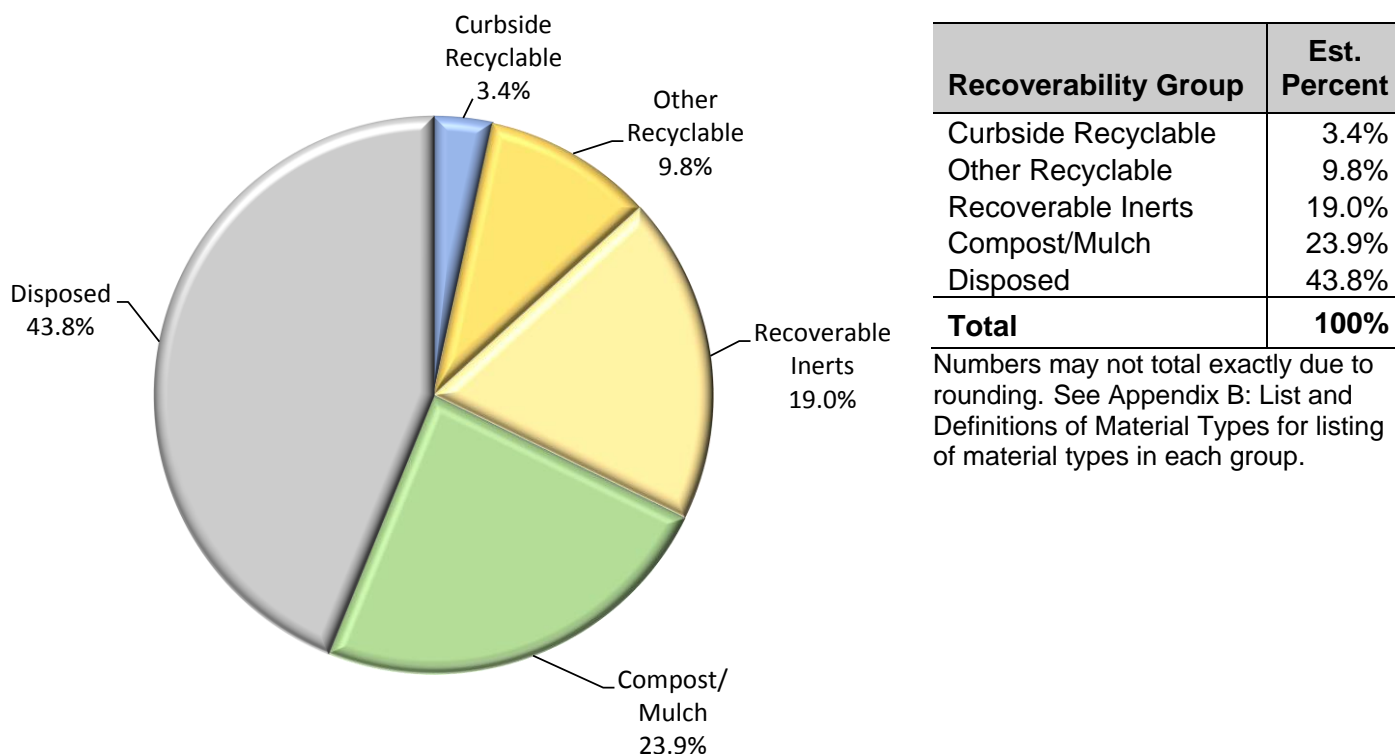

The above pie chart and table were constructed using sector percentage data obtained from the 2014 vehicle surveys applied to 2014 composition results. See *Special Note Regarding Sector Percentages* on Page 3 for a further explanation of the sector percentage issues.

Detailed Composition

Table 25 presents the detailed composition results for the commercial self-hauled subsector. Table 25 presents the 2014 sector percentages applied to the 2014 waste composition data and, for comparison, the sector percentages obtained in the 2008 Statewide Waste Characterization Study applied to the 2014 waste composition data. When comparing compositions from the two sets of data, composition percentages for most materials may be similar, but tonnage amounts can be very different. See *Special Note Regarding Sector Percentages* on Page 3 for a further explanation of the sector percentage issues.

Table 25: Composition of Commercial Self-Hauled Disposed Waste

Material	Est. Using 2014 Sector Percentages			Est. Using 2008 Sector Percentages		
	Estimated Percent	+ / -	Estimated Tons	Estimated Percent	+ / -	Estimated Tons
Paper	3.5%		120,401	3.3%		174,936
Uncoated Corrugated Cardboard	2.0%	1.1%	71,444	2.1%	1.3%	110,420
Paper Bags	0.2%	0.2%	5,536	0.1%	0.2%	5,712
Newspaper	0.0%	0.0%	1,055	0.0%	0.0%	1,363
White Ledger Paper	0.0%	0.1%	1,718	0.0%	0.0%	1,752
Other Office Paper	0.0%	0.0%	1,203	0.0%	0.0%	1,226
Magazines and Catalogs	0.1%	0.1%	2,832	0.1%	0.1%	2,901
Phone Books and Directories	0.1%	0.1%	2,517	0.1%	0.1%	3,362
Other Miscellaneous Paper	0.6%	0.5%	19,848	0.6%	0.5%	30,592
Remainder/Composite Paper	0.4%	0.2%	14,250	0.3%	0.2%	17,608
Glass	0.6%		22,123	0.5%		26,188
Clear Glass Bottles and Containers	0.1%	0.1%	2,728	0.1%	0.0%	2,971
Green Glass Bottles and Containers	0.0%	0.0%	439	0.0%	0.0%	451
Brown Glass Bottles and Containers	0.1%	0.1%	2,026	0.0%	0.1%	2,044
Other Glass Colored Bottles and Containers	0.0%	0.0%	9	0.0%	0.0%	14
Flat Glass	0.3%	0.2%	8,943	0.2%	0.2%	9,036
Remainder/Composite Glass	0.2%	0.2%	7,978	0.2%	0.2%	11,670
Metal	3.2%		111,828	2.8%		149,072
Tin/Steel Cans	0.1%	0.1%	2,446	0.0%	0.1%	2,610
Major Appliances	0.1%	0.1%	1,750	0.1%	0.1%	2,677
Used Oil Filters	0.0%	0.0%	0	0.0%	0.0%	0
Other Ferrous	0.8%	0.4%	28,619	0.7%	0.4%	37,649
Aluminum Cans	0.0%	0.0%	180	0.0%	0.0%	188
Other Non-Ferrous	0.6%	0.5%	21,093	0.6%	0.6%	34,176
Remainder/Composite Metal	1.7%	0.8%	57,741	1.4%	0.7%	71,773
Electronics	0.4%		13,474	0.3%		16,634
Brown Goods	0.0%	0.0%	442	0.0%	0.0%	443
Computer-related Electronics	0.2%	0.3%	8,390	0.2%	0.2%	8,463
Other Small Consumer Electronics	0.1%	0.2%	4,642	0.1%	0.2%	7,728
Video Display Devices	0.0%	0.0%	0	0.0%	0.0%	0
Plastic	5.5%		192,490	4.9%		257,242
PETE Containers	0.1%	0.1%	3,251	0.1%	0.1%	3,292
HDPE Containers	0.0%	0.0%	318	0.0%	0.0%	342
Miscellaneous Plastic Containers	0.0%	0.0%	393	0.0%	0.0%	409
Plastic Trash Bags	0.1%	0.1%	2,815	0.1%	0.1%	3,963
Plastic Grocery and Other Merchandise Bags	0.0%	0.0%	427	0.0%	0.0%	462
Non-Bag Commercial and Industrial Packaging Film	0.1%	0.1%	3,075	0.1%	0.1%	3,111
Film Products	0.2%	0.3%	7,227	0.3%	0.4%	13,595
Other Film	0.1%	0.1%	3,849	0.1%	0.1%	4,834
Durable Plastic Items	2.3%	1.5%	79,272	1.8%	1.1%	97,037
Remainder/Composite Plastic	2.6%	1.9%	91,864	2.5%	1.9%	130,195

Confidence intervals calculated at the 90% confidence level. Percentages for material types may not total 100% due to rounding.

More detailed composition tables can be found in Appendix D: Expanded Statewide Waste Characterization Tables

The above table presents the 2014 sector percentages applied to the 2014 waste composition data and, for comparison, the sector percentages obtained in the 2008 Statewide Waste Characterization Study applied to the 2014 waste composition data. See *Special Note Regarding Sector Percentages* on Page 3 for a further explanation of the sector percentage issues.

Table 25 (continued): Composition of Commercial Self-Hauled Disposed Waste

Material	Est. Using 2014 Sector Percentages			Est. Using 2008 Sector Percentages		
	Estimated Percent	+ / -	Estimated Tons	Estimated Percent	+ / -	Estimated Tons
Other Organic	19.7%		686,684	21.1%		1,113,522
Food	0.3%	0.3%	11,848	0.2%	0.2%	13,044
Leaves and Grass	3.0%	3.1%	105,942	3.5%	3.8%	182,396
Prunings and Trimmings	5.1%	3.6%	178,039	6.0%	4.5%	314,718
Branches and Stumps	2.5%	2.2%	86,838	2.9%	2.7%	154,702
Manures	0.2%	0.3%	6,830	0.1%	0.2%	6,806
Textiles	1.4%	0.6%	50,192	1.3%	0.6%	70,310
Carpet	5.7%	2.9%	199,030	5.5%	3.3%	288,908
Remainder/Composite Organic	1.4%	1.2%	47,965	1.6%	1.5%	82,638
Inerts and Other	56.4%		1,967,258	56.7%		2,995,314
Concrete	3.8%	2.2%	133,417	3.8%	2.4%	198,665
Asphalt Paving	1.9%	3.1%	65,490	2.3%	3.8%	123,205
Asphalt Roofing	2.2%	1.6%	74,990	1.7%	1.2%	89,766
Lumber	26.9%	5.3%	938,070	26.0%	6.0%	1,374,760
Gypsum Board	4.3%	2.5%	148,294	4.2%	2.8%	219,533
Rock, Soil and Fines	6.9%	3.8%	241,201	7.7%	4.4%	405,813
Remainder/Composite Inerts and Other	10.5%	4.6%	365,796	11.0%	5.4%	583,573
Household Hazardous Waste (HHW)	0.0%		839	0.0%		891
Paint	0.0%	0.0%	75	0.0%	0.0%	74
Vehicle & Equipment Fluids	0.0%	0.0%	0	0.0%	0.0%	0
Used Oil	0.0%	0.0%	0	0.0%	0.0%	0
Batteries	0.0%	0.0%	146	0.0%	0.0%	186
Remainder/Composite Household Hazardous	0.0%	0.0%	618	0.0%	0.0%	631
Special Waste	10.5%		366,214	10.3%		546,786
Ash	0.0%	0.0%	0	0.0%	0.0%	0
Treated Medical Waste	0.0%	0.0%	0	0.0%	0.0%	0
Bulky Items	9.9%	4.3%	344,809	9.9%	4.9%	525,447
Tires	0.6%	1.0%	21,363	0.4%	0.7%	21,286
Remainder/Composite Special Waste	0.0%	0.0%	42	0.0%	0.0%	53
Mixed Residue	0.1%		4,984	0.1%		5,162
Totals	100.0%		3,486,297	100.0%		5,285,747
Sample Count	134			134		

Confidence intervals calculated at the 90% confidence level. Percentages for material types may not total 100% due to rounding.

More detailed composition tables can be found in Appendix D: Expanded Statewide Waste Characterization Tables

The above table presents the 2014 sector percentages applied to the 2014 waste composition data and, for comparison, the sector percentages obtained in the 2008 Statewide Waste Characterization Study applied to the 2014 waste composition data. See *Special Note Regarding Sector Percentages* on Page 3 for a further explanation of the sector percentage issues.

Residential Self-Hauled Waste

The objective of this section is to present the characterization data for California's residential self-hauled waste stream at the state level. This subsector includes waste that is hauled to a solid waste disposal site by a resident from their home.

Overview and Analysis

Samples of residential self-hauled waste were obtained from randomly selected vehicles at the landfills and transfer stations visited in this study. See Appendix A: Detailed Methodology for a description of the methods used in selecting, sorting, and analyzing samples.

Table 26 presents the numbers of samples that were obtained in each region and each season. Overall, 116 samples of residential self-hauled waste were sorted.

Table 26: Residential Self-Hauled Samples Obtained, by Region and Season

Season	Bay Area	Coastal	Mountain	Southern	Valley	Totals
Winter 2014	7	7	11	6	4	35
Spring 2014	6	10	9	5	4	34
Summer 2014	3	2	4	4	4	17
Fall 2014	10	2	7	4	7	30
Totals	26	21	31	19	19	116

See Appendix A: Detailed Methodology for the names and locations of the solid waste facilities that were visited.

Composition results by **Material Class** for residential self-hauled waste are illustrated in Figure 19 and described in detail in Table 28. Nearly half (49 percent) of the residential self-hauled waste was made up of **Inerts and Other** materials.

Figure 19: Overview of Residential Self-Hauled Disposed Waste

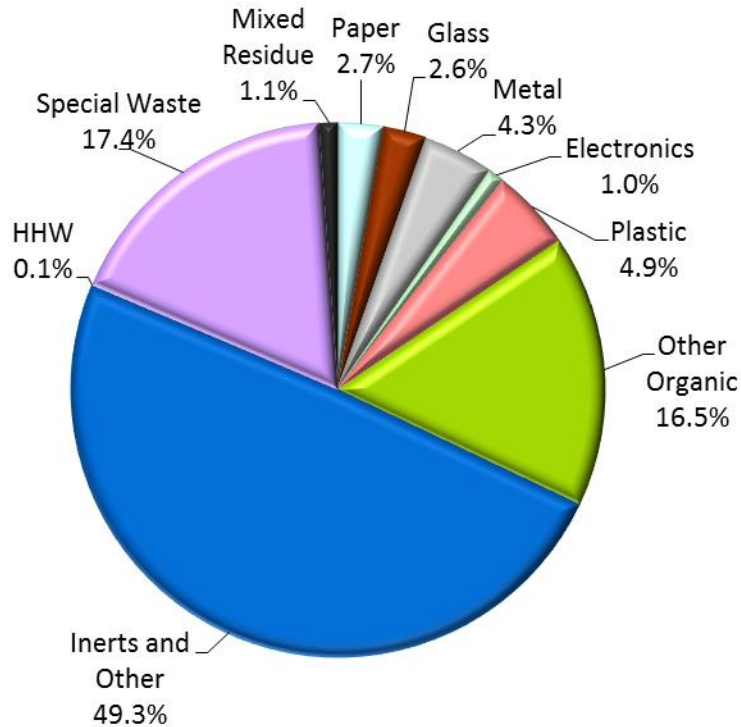

Material Class	Est. Percent
Paper	2.7%
Glass	2.6%
Metal	4.3%
Electronics	1.0%
Plastic	4.9%
Other Organic	16.5%
Inerts and Other	49.3%
HHW	0.1%
Special Waste	17.4%
Mixed Residue	1.1%
Total	100%

Numbers may not total exactly due to rounding.

The above pie chart and table were constructed using sector percentage data obtained from the 2014 vehicle surveys applied to 2014 composition results. See *Special Note Regarding Sector Percentages* on Page 3 for a further explanation of the sector percentage issues.

Ten Most Prevalent Materials

Table 27 lists the 10 most prevalent *material types* for the residential self-hauled waste stream. This list includes five recoverable materials which made up approximately 17 percent of the residential self-hauled waste stream. The top three recoverable materials were *gypsum board, concrete, and carpet*. Compost/mulch materials accounted for another 38 percent and included *lumber, leaves and grass, and branches and stumps*.

Table 27: Ten Most Prevalent Material Types in Residential Self-Hauled Disposed Waste

Material	Estimated Percent	Cumulative Percent	Estimated Tons
Lumber	33.4%	33.4%	318,332
Bulky Items	17.1%	50.5%	162,704
Remainder/Composite Inerts and Other	4.6%	55.2%	44,149
Gypsum Board	4.6%	59.8%	43,892
Concrete	4.0%	63.7%	37,614
Carpet	3.9%	67.6%	36,959
Leaves and Grass	2.7%	70.3%	25,584
Textiles	2.4%	72.7%	22,556
Rock, Soil and Fines	2.3%	75.0%	22,246
Branches and Stumps	2.3%	77.3%	21,507
Total	77.3%		735,544

Any differences between *cumulative percent* figures and the sum of *estimated percent* figures are due to rounding. The above table was constructed using sector percentage data obtained from the 2014 vehicle surveys applied to 2014 composition results. See *Special Note Regarding Sector Percentages* on Page 3 for a further explanation of the sector percentage issues.

Recoverability

The Disposed group was largest Recoverability Group in the residential self-hauled waste stream, at nearly 49 percent of the waste stream. The Compost/Mulch group, the second-largest group by weight, accounted for almost 27 percent. Recoverable Inerts (11 percent), Other Recyclable (10 percent), and Curbside Recyclable (4 percent) accounted for the remainder. Composition estimates by Recoverability Group for the residential self-hauled waste stream are illustrated in Figure 20.

Figure 20: Recoverability of Residential Self-Hauled Disposed Waste

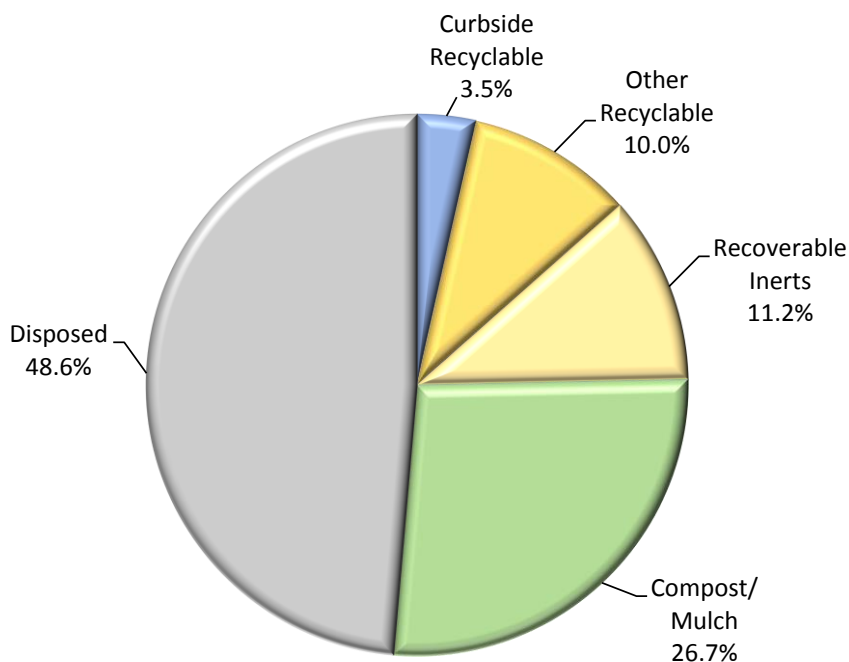

Recoverability Group	Est. Percent
Curbside Recyclable	3.5%
Other Recyclable	10.0%
Recoverable Inerts	11.2%
Compost/Mulch	26.7%
Disposed	48.6%
Total	100%

Numbers may not total exactly due to rounding. See Appendix B: List and Definitions of Material Types for listing of material types in each group.

The above pie chart and table were constructed using sector percentage data obtained from the 2014 vehicle surveys applied to 2014 composition results. See *Special Note Regarding Sector Percentages* on Page 3 for a further explanation of the sector percentage issues.

Detailed Composition

Table 28 presents the detailed composition results for the residential self-hauled subsector. Table 28 presents the 2014 sector percentages applied to the 2014 waste composition data and, for comparison, the sector percentages obtained in the 2008 Statewide Waste Characterization Study applied to the 2014 waste composition data. When comparing compositions from the two sets of data, composition percentages for most materials may be similar, but tonnage amounts can be very different. See *Special Note Regarding Sector Percentages* on Page 3 for a further explanation of the sector percentage issues.

Table 28: Composition of Residential Self-Hauled Disposed Waste

Material	Est. Using 2014 Sector Percentages			Est. Using 2008 Sector Percentages		
	Estimated Percent	+ / -	Estimated Tons	Estimated Percent	+ / -	Estimated Tons
Paper	2.7%		26,118	3.1%		31,554
Uncoated Corrugated Cardboard	1.3%	0.7%	12,809	1.4%	0.7%	14,246
Paper Bags	0.0%	0.0%	147	0.0%	0.0%	260
Newspaper	0.1%	0.0%	532	0.1%	0.1%	898
White Ledger Paper	0.0%	0.0%	255	0.0%	0.0%	322
Other Office Paper	0.0%	0.0%	19	0.0%	0.0%	27
Magazines and Catalogs	0.2%	0.2%	1,665	0.2%	0.2%	1,978
Phone Books and Directories	0.0%	0.1%	328	0.0%	0.1%	334
Other Miscellaneous Paper	0.5%	0.3%	5,073	0.6%	0.3%	6,000
Remainder/Composite Paper	0.6%	0.3%	5,290	0.7%	0.3%	7,489
Glass	2.6%		24,564	2.7%		27,430
Clear Glass Bottles and Containers	0.2%	0.1%	2,013	0.3%	0.1%	2,631
Green Glass Bottles and Containers	0.0%	0.0%	216	0.0%	0.0%	318
Brown Glass Bottles and Containers	0.1%	0.1%	630	0.1%	0.1%	856
Other Glass Colored Bottles and Containers	0.0%	0.0%	48	0.0%	0.0%	46
Flat Glass	1.4%	1.0%	13,360	1.5%	1.0%	14,892
Remainder/Composite Glass	0.9%	0.7%	8,297	0.8%	0.7%	8,687
Metal	4.3%		40,753	4.6%		47,212
Tin/Steel Cans	0.8%	1.0%	7,428	0.8%	0.9%	7,796
Major Appliances	0.3%	0.4%	2,425	0.2%	0.4%	2,449
Used Oil Filters	0.0%	0.0%	133	0.0%	0.0%	303
Other Ferrous	1.6%	1.3%	14,808	1.6%	1.3%	16,723
Aluminum Cans	0.0%	0.0%	195	0.0%	0.0%	296
Other Non-Ferrous	0.1%	0.0%	550	0.1%	0.1%	775
Remainder/Composite Metal	1.6%	0.8%	15,214	1.8%	1.1%	18,869
Electronics	1.0%		9,507	1.0%		10,640
Brown Goods	0.3%	0.4%	3,146	0.3%	0.3%	3,334
Computer-related Electronics	0.0%	0.0%	54	0.0%	0.0%	85
Other Small Consumer Electronics	0.1%	0.2%	1,212	0.1%	0.1%	1,211
Video Display Devices	0.5%	0.8%	5,095	0.6%	0.7%	6,010
Plastic	4.9%		46,947	5.1%		52,570
PETE Containers	0.1%	0.1%	1,101	0.2%	0.1%	1,535
HDPE Containers	0.1%	0.0%	518	0.1%	0.0%	748
Miscellaneous Plastic Containers	0.0%	0.0%	434	0.1%	0.0%	539
Plastic Trash Bags	0.1%	0.1%	1,037	0.2%	0.1%	1,602
Plastic Grocery and Other Merchandise Bags	0.0%	0.0%	415	0.0%	0.0%	491
Non-Bag Commercial and Industrial Packaging Film	0.0%	0.0%	320	0.1%	0.0%	576
Film Products	0.1%	0.1%	1,119	0.1%	0.1%	1,125
Other Film	0.2%	0.1%	2,307	0.3%	0.2%	3,217
Durable Plastic Items	2.3%	1.0%	21,454	2.3%	1.0%	23,168
Remainder/Composite Plastic	1.9%	1.2%	18,241	1.9%	1.2%	19,569

Confidence intervals calculated at the 90% confidence level. Percentages for material types may not total 100% due to rounding.

More detailed composition tables can be found in Appendix D: Expanded Statewide Waste Characterization Tables

The above table presents the 2014 sector percentages applied to the 2014 waste composition data and, for comparison, the sector percentages obtained in the 2008 Statewide Waste Characterization Study applied to the 2014 waste composition data. See *Special Note Regarding Sector Percentages* on Page 3 for a further explanation of the sector percentage issues.

Table 28 (continued): Composition of Residential Self-Hauled Disposed Waste

Material	Est. Using 2014 Sector Percentages			Est. Using 2008 Sector Percentages		
	Estimated Percent	+ / -	Estimated Tons	Estimated Percent	+ / -	Estimated Tons
Other Organic	16.5%		157,190	17.2%		175,810
Food	0.7%	0.3%	6,687	1.0%	0.4%	10,047
Leaves and Grass	2.7%	2.6%	25,584	2.9%	2.5%	29,268
Prunings and Trimmings	2.1%	1.8%	19,891	2.1%	1.7%	21,523
Branches and Stumps	2.3%	2.5%	21,507	2.3%	2.5%	23,271
Manures	1.5%	2.4%	14,359	1.4%	2.2%	14,424
Textiles	2.4%	1.1%	22,556	2.5%	1.1%	25,980
Carpet	3.9%	2.7%	36,959	3.8%	2.6%	38,447
Remainder/Composite Organic	1.0%	0.6%	9,648	1.3%	0.7%	12,849
Inerts and Other	49.3%		469,132	48.2%		493,159
Concrete	4.0%	4.1%	37,614	3.8%	3.9%	39,241
Asphalt Paving	0.0%	0.0%	0	0.0%	0.0%	0
Asphalt Roofing	0.3%	0.4%	2,898	0.4%	0.5%	4,233
Lumber	33.4%	6.9%	318,332	32.7%	6.7%	334,431
Gypsum Board	4.6%	4.3%	43,892	4.4%	4.2%	45,499
Rock, Soil and Fines	2.3%	1.8%	22,246	2.4%	1.7%	24,825
Remainder/Composite Inerts and Other	4.6%	2.6%	44,149	4.4%	2.4%	44,931
Household Hazardous Waste (HHW)	0.1%		845	0.1%		1,089
Paint	0.0%	0.0%	5	0.0%	0.0%	6
Vehicle & Equipment Fluids	0.0%	0.0%	0	0.0%	0.0%	0
Used Oil	0.0%	0.0%	38	0.0%	0.0%	87
Batteries	0.0%	0.0%	110	0.0%	0.0%	159
Remainder/Composite Household Hazardous	0.1%	0.1%	692	0.1%	0.1%	837
Special Waste	17.4%		165,931	16.8%		171,782
Ash	0.1%	0.1%	787	0.1%	0.1%	817
Treated Medical Waste	0.0%	0.0%	0	0.0%	0.0%	0
Bulky Items	17.1%	5.7%	162,704	16.5%	5.5%	168,483
Tires	0.3%	0.3%	2,424	0.2%	0.3%	2,463
Remainder/Composite Special Waste	0.0%	0.0%	15	0.0%	0.0%	20
Mixed Residue	1.1%		10,848	1.2%		11,791
Totals	100.0%		951,833	100.0%		1,023,039
Sample Count	116			116		

Confidence intervals calculated at the 90% confidence level. Percentages for material types may not total 100% due to rounding.

More detailed composition tables can be found in Appendix D: Expanded Statewide Waste Characterization Tables

The above table presents the 2014 sector percentages applied to the 2014 waste composition data and, for comparison, the sector percentages obtained in the 2008 Statewide Waste Characterization Study applied to the 2014 waste composition data. See *Special Note Regarding Sector Percentages* on Page 3 for a further explanation of the sector percentage issues.

Franchised Commercial Plus Commercial Self-Hauled Disposed Waste

The objective of this section is to present the characterization data that combines California’s commercial disposed waste streams at the state level. This section combines the results of the franchised commercial sector and the commercial self-hauled subsector.

Overview and Analysis

Composition estimates by **Material Class** for the franchised commercial plus commercial self-hauled waste stream are illustrated in Figure 21. The largest **Material Class** in this waste stream was **Other Organic**, which accounted for almost one-third (31 percent) of the waste stream by weight, followed by **Inerts and Other** (27 percent) and **Paper** (17 percent).

Figure 21: Overview of Franchised Commercial Plus Commercial Self-Hauled Disposed Waste

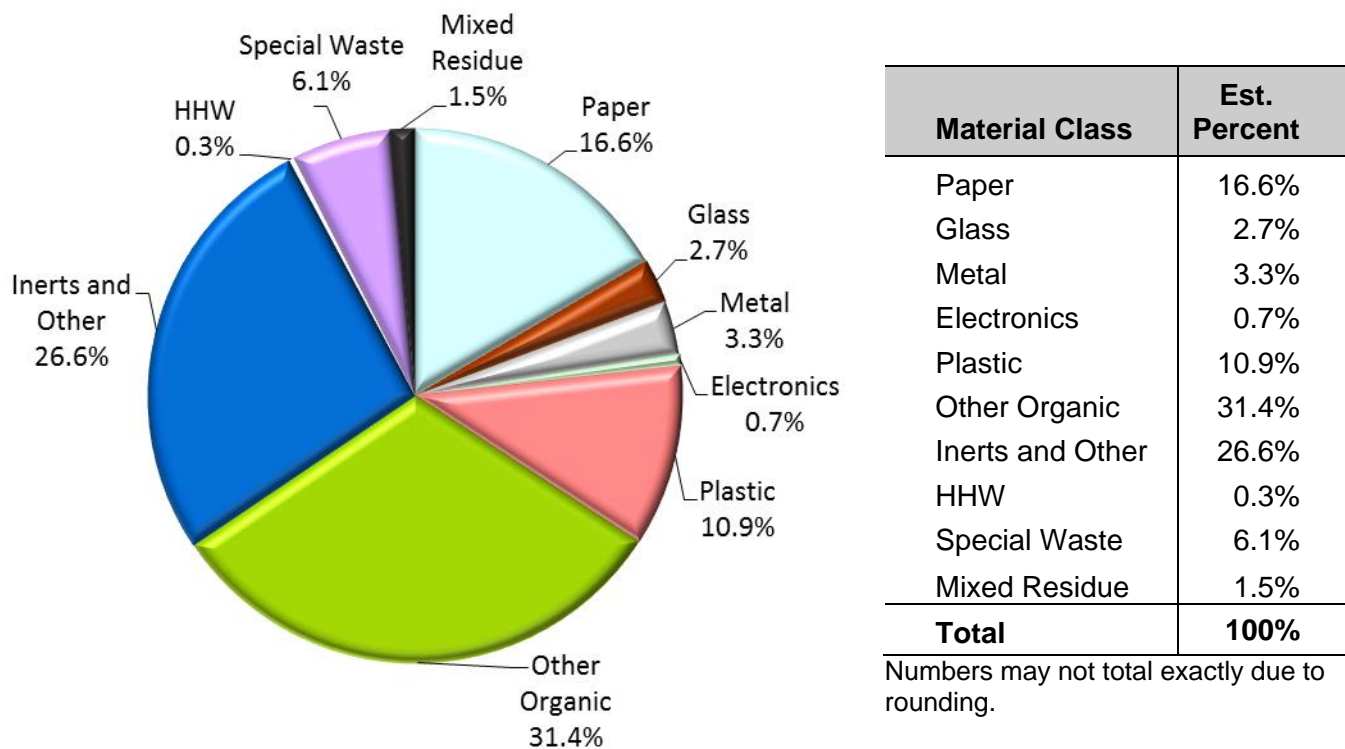

The above pie chart and table were constructed using sector percentage data obtained from the 2014 vehicle surveys applied to 2014 composition results. See *Special Note Regarding Sector Percentages* on Page 3 for a further explanation of the sector percentage issues.

Ten Most Prevalent Materials

Of the 10 most prevalent *material types* in the franchised commercial plus commercial self-hauled waste stream by weight, as shown in Table 29, *uncoated corrugated cardboard, other miscellaneous paper, rock, soil, and fines, and textiles* were recoverable. Combined, they accounted for about 14 percent of the waste stream. *Food, lumber, and leaves and grass* were compost/mulch *material types* and accounted for another 34 percent of the waste stream. Together, the top 10 *material types* comprised approximately 64 percent of this waste stream.

Table 29: Ten Most Prevalent Material Types in Franchised Commercial Plus Commercial Self-Hauled Disposed Waste

Material	Estimated Percent	Cumulative Percent	Estimated Tons
Food	15.6%	15.6%	2,402,770
Lumber	15.4%	31.1%	2,377,901
Remainder/Composite Paper	6.7%	37.8%	1,038,641
Bulky Items	5.2%	43.0%	802,261
Uncoated Corrugated Cardboard	4.3%	47.3%	665,574
Remainder/Composite Inerts and Other	3.6%	51.0%	558,685
Other Miscellaneous Paper	3.6%	54.6%	558,665
Leaves and Grass	3.1%	57.7%	483,683
Rock, Soil and Fines	3.1%	60.8%	471,708
Textiles	2.7%	63.5%	416,021
Total	63.5%		9,775,908

Any differences between *cumulative percent* figures and the sum of *estimated percent* figures are due to rounding. The above table was constructed using sector percentage data obtained from the 2014 vehicle surveys applied to 2014 composition results. See *Special Note Regarding Sector Percentages* on Page 3 for a further explanation of the sector percentage issues.

Recoverability

Composition estimates by Recoverability Group for the franchised commercial plus commercial self-hauled waste stream are illustrated in Figure 22. The two largest Recoverability Groups were Compost/Mulch and Disposed, which accounted for 40 percent and 31 percent of the waste stream by weight, respectively.

Figure 22: Recoverability of Franchised Commercial Plus Commercial Self-Hauled Disposed Waste

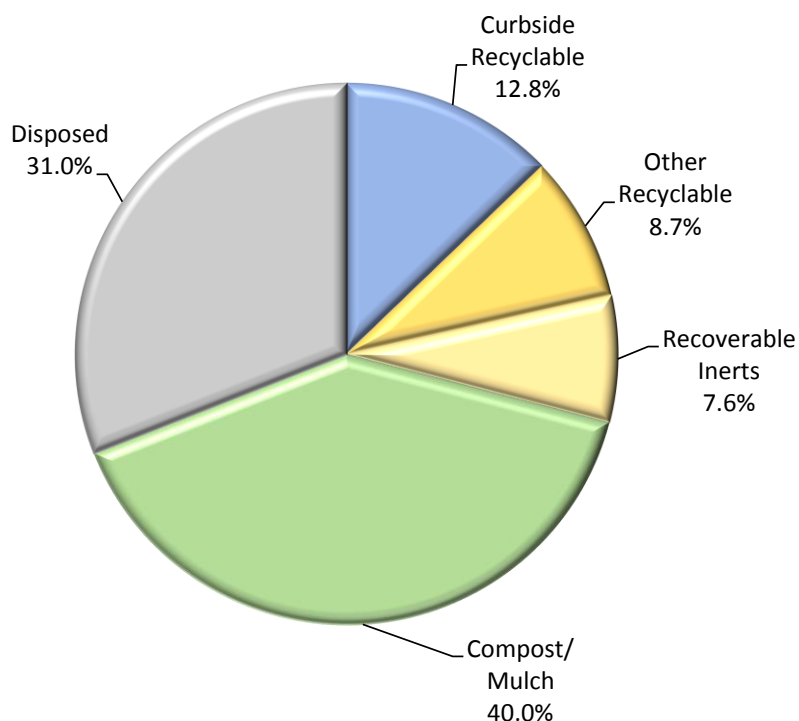

Recoverability Group	Est. Percent
Curbside Recyclable	12.8%
Other Recyclable	8.7%
Recoverable Inerts	7.6%
Compost/Mulch	40.0%
Disposed	31.0%
Total	100%

Numbers may not total exactly due to rounding. See Appendix B: List and Definitions of Material Types for listing of material types in each group.

The above pie chart and table were constructed using sector percentage data obtained from the 2014 vehicle surveys applied to 2014 composition results. See *Special Note Regarding Sector Percentages* on Page 3 for a further explanation of the sector percentage issues.

Detailed Composition

The composition percentages by weight for each *material type* in California's franchised commercial plus commercial self-hauled waste stream are listed in Table 30. Table 30 presents the 2014 sector percentages applied to the 2014 waste composition data and, for comparison, the sector percentages obtained in the 2008 Statewide Waste Characterization Study applied to the 2014 waste composition data. When comparing compositions from the two sets of data, composition percentages for most materials may be similar, but tonnage amounts can be very different. See *Special Note Regarding Sector Percentages* on Page 3 for a further explanation of the sector percentage issues.

Table 30: Composition of Franchised Commercial Plus Commercial Self-Hauled Disposed Waste

Material	Est. Using 2014 Sector Percentages			Est. Using 2008 Sector Percentages		
	Estimated Percent	+ / -	Estimated Tons	Estimated Percent	+ / -	Estimated Tons
Paper	16.6%		2,554,320	16.0%		3,300,757
Uncoated Corrugated Cardboard	4.3%	1.0%	665,574	4.6%	1.2%	945,165
Paper Bags	0.2%	0.1%	25,838	0.1%	0.1%	29,819
Newspaper	0.4%	0.2%	66,053	0.4%	0.1%	75,527
White Ledger Paper	0.5%	0.3%	80,719	0.5%	0.3%	104,932
Other Office Paper	0.2%	0.2%	37,983	0.2%	0.2%	48,450
Magazines and Catalogs	0.5%	0.1%	72,987	0.4%	0.1%	88,821
Phone Books and Directories	0.1%	0.0%	7,862	0.0%	0.0%	9,344
Other Miscellaneous Paper	3.6%	0.7%	558,665	3.6%	0.7%	736,292
Remainder/Composite Paper	6.7%	0.9%	1,038,641	6.1%	0.9%	1,262,407
Glass	2.7%		418,889	2.6%		531,001
Clear Glass Bottles and Containers	0.6%	0.2%	92,017	0.5%	0.2%	109,155
Green Glass Bottles and Containers	0.2%	0.1%	26,176	0.2%	0.1%	31,633
Brown Glass Bottles and Containers	0.3%	0.1%	41,944	0.3%	0.2%	56,653
Other Glass Colored Bottles and Containers	0.0%	0.0%	6,158	0.0%	0.0%	8,047
Flat Glass	0.2%	0.2%	26,695	0.2%	0.2%	39,555
Remainder/Composite Glass	1.5%	2.1%	225,898	1.4%	2.0%	285,959
Metal	3.3%		500,420	3.2%		658,714
Tin/Steel Cans	0.5%	0.2%	75,076	0.5%	0.2%	97,394
Major Appliances	0.1%	0.1%	13,328	0.1%	0.1%	12,609
Used Oil Filters	0.0%	0.0%	571	0.0%	0.0%	530
Other Ferrous	0.9%	0.4%	144,669	1.0%	0.4%	197,106
Aluminum Cans	0.1%	0.0%	18,029	0.1%	0.0%	22,075
Other Non-Ferrous	0.6%	0.4%	91,924	0.7%	0.5%	140,863
Remainder/Composite Metal	1.0%	0.4%	156,822	0.9%	0.4%	188,137
Electronics	0.7%		103,587	0.6%		115,052
Brown Goods	0.3%	0.2%	39,913	0.2%	0.2%	48,758
Computer-related Electronics	0.1%	0.1%	20,695	0.1%	0.1%	24,208
Other Small Consumer Electronics	0.1%	0.0%	12,640	0.1%	0.1%	16,407
Video Display Devices	0.2%	0.2%	30,339	0.1%	0.1%	25,680
Plastic	10.9%		1,683,948	10.5%		2,168,382
PETE Containers	0.6%	0.2%	85,617	0.5%	0.2%	104,595
HDPE Containers	0.4%	0.1%	68,669	0.4%	0.2%	89,390
Miscellaneous Plastic Containers	0.5%	0.1%	81,058	0.5%	0.2%	101,785
Plastic Trash Bags	1.4%	0.2%	211,216	1.3%	0.2%	261,315
Plastic Grocery and Other Merchandise Bags	0.3%	0.0%	41,627	0.2%	0.0%	50,775
Non-Bag Commercial and Industrial Packaging Film	0.4%	0.1%	63,224	0.4%	0.2%	87,842
Film Products	0.4%	0.6%	67,218	0.6%	0.7%	113,378
Other Film	1.7%	0.3%	255,417	1.6%	0.3%	321,650
Durable Plastic Items	2.6%	0.8%	406,769	2.4%	0.7%	499,128
Remainder/Composite Plastic	2.6%	0.6%	403,134	2.6%	0.7%	538,523

Confidence intervals calculated at the 90% confidence level. Percentages for material types may not total 100% due to rounding.

More detailed composition tables can be found in Appendix D: Expanded Statewide Waste Characterization Tables

The above table presents the 2014 sector percentages applied to the 2014 waste composition data and, for comparison, the sector percentages obtained in the 2008 Statewide Waste Characterization Study applied to the 2014 waste composition data. See *Special Note Regarding Sector Percentages* on Page 3 for a further explanation of the sector percentage issues.

Table 30 (continued): Composition of Franchised Commercial Plus Commercial Self-Hauled Disposed Waste

Material	Est. Using 2014 Sector Percentages			Est. Using 2008 Sector Percentages		
	Estimated Percent	+ / -	Estimated Tons	Estimated Percent	+ / -	Estimated Tons
Other Organic	31.4%		4,832,395	30.3%		6,243,002
Food	15.6%	2.8%	2,402,770	14.1%	2.6%	2,911,474
Leaves and Grass	3.1%	1.8%	483,683	3.3%	1.9%	676,246
Prunings and Trimmings	2.5%	1.2%	389,288	2.8%	1.5%	581,556
Branches and Stumps	1.9%	1.4%	295,252	2.1%	1.4%	425,468
Manures	1.0%	1.1%	157,285	1.0%	1.0%	197,226
Textiles	2.7%	0.9%	416,021	2.6%	0.9%	541,205
Carpet	2.0%	1.0%	314,577	2.1%	1.1%	433,988
Remainder/Composite Organic	2.4%	0.6%	373,519	2.3%	0.7%	475,840
Inerts and Other	26.6%		4,100,096	28.7%		5,912,664
Concrete	1.5%	0.6%	224,588	1.5%	0.7%	315,352
Asphalt Paving	0.5%	0.7%	70,269	0.6%	1.0%	130,364
Asphalt Roofing	1.0%	0.7%	154,630	1.1%	0.9%	217,189
Lumber	15.4%	2.5%	2,377,901	16.3%	2.8%	3,348,924
Gypsum Board	1.6%	0.7%	242,316	1.6%	0.8%	329,425
Rock, Soil and Fines	3.1%	1.2%	471,708	3.6%	1.4%	740,230
Remainder/Composite Inerts and Other	3.6%	1.4%	558,685	4.0%	1.6%	831,179
Household Hazardous Waste (HHW)	0.3%		42,555	0.2%		40,775
Paint	0.1%	0.2%	23,061	0.1%	0.1%	20,722
Vehicle & Equipment Fluids	0.0%	0.0%	0	0.0%	0.0%	0
Used Oil	0.0%	0.0%	661	0.0%	0.0%	565
Batteries	0.0%	0.0%	3,276	0.0%	0.0%	3,908
Remainder/Composite Household Hazardous	0.1%	0.1%	15,556	0.1%	0.1%	15,580
Special Waste	6.1%		934,818	6.5%		1,343,591
Ash	0.1%	0.1%	11,407	0.1%	0.1%	13,755
Treated Medical Waste	0.0%	0.1%	5,118	0.0%	0.1%	7,668
Bulky Items	5.2%	1.7%	802,261	5.6%	1.9%	1,162,759
Tires	0.2%	0.2%	25,601	0.1%	0.2%	27,312
Remainder/Composite Special Waste	0.6%	0.5%	90,431	0.6%	0.6%	132,098
Mixed Residue	1.5%		225,206	1.3%		273,300
Totals	100.0%		15,396,234	100.0%		20,587,239
Sample Count	385			385		

Confidence intervals calculated at the 90% confidence level. Percentages for material types may not total 100% due to rounding.

More detailed composition tables can be found in Appendix D: Expanded Statewide Waste Characterization Tables

The above table presents the 2014 sector percentages applied to the 2014 waste composition data and, for comparison, the sector percentages obtained in the 2008 Statewide Waste Characterization Study applied to the 2014 waste composition data. See *Special Note Regarding Sector Percentages* on Page 3 for a further explanation of the sector percentage issues.

Franchised Residential Plus Residential Self-Hauled Disposed Waste

The objective of this section is to present the characterization data that combines California’s residential disposed waste streams at the state level. This section combines the results of the franchised residential sector and the residential self-haul subsector.

Overview and Analysis

Composition estimates by **Material Class** for the franchised residential plus residential self-hauled waste stream are illustrated in Figure 23. The largest **Material Class** in this waste stream was **Other Organic**, which accounted for nearly 44 percent of the waste stream by weight, followed by **Paper** (18 percent) and **Inerts and Other** (13 percent).

Figure 23: Overview of Franchised Residential Plus Residential Self-Hauled Disposed Waste

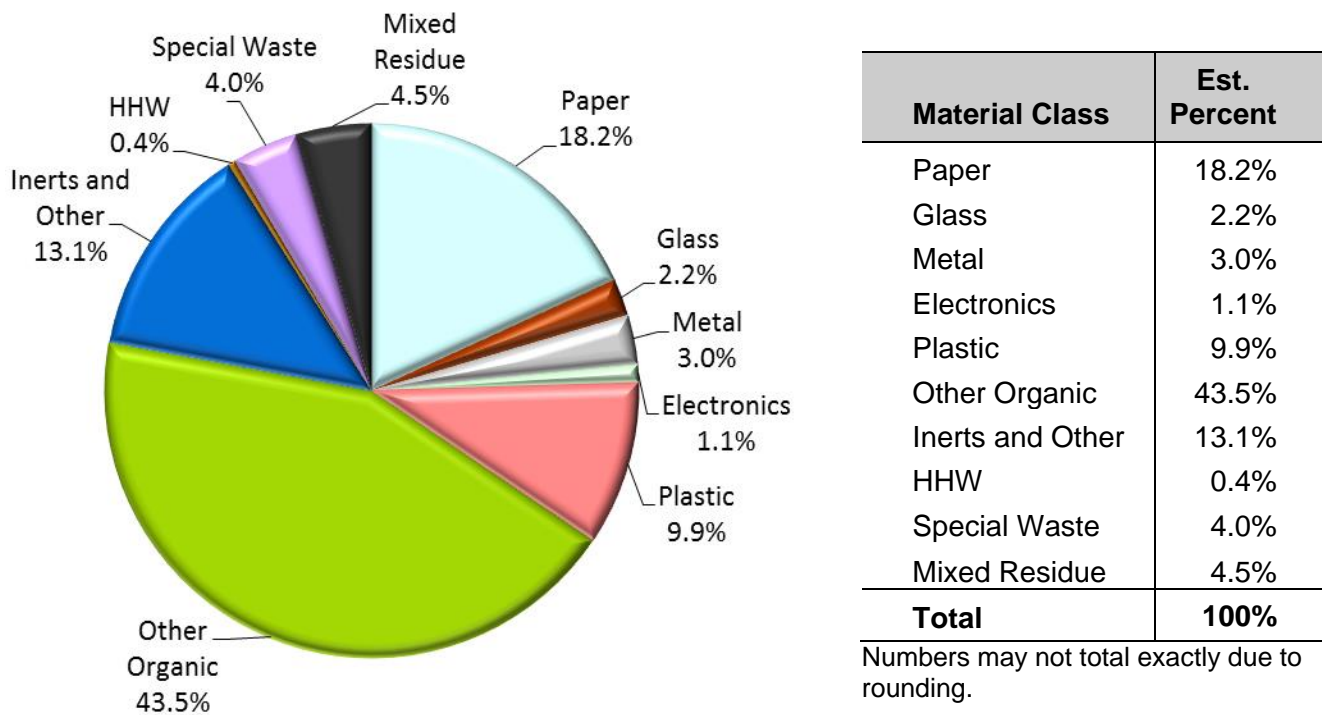

The above pie chart and table were constructed using sector percentage data obtained from the 2014 vehicle surveys applied to 2014 composition results. See *Special Note Regarding Sector Percentages* on Page 3 for a further explanation of the sector percentage issues.

Ten Most Prevalent Materials

Of the 10 most prevalent *material types* in the franchised residential plus residential self-hauled waste stream by weight, as shown in Table 31, *textiles* and *other miscellaneous paper* were the only recoverable *material types*. They accounted for about 10 percent of the waste stream. Four compost/mulch materials accounted for about 37 percent of the waste stream. Combined, the top 10 *material types* comprised approximately 69 percent of the waste stream.

Table 31: Ten Most Prevalent Material Types in Franchised Residential Plus Residential Self-Hauled Disposed Waste

Material	Estimated Percent	Cumulative Percent	Estimated Tons
Food	20.6%	20.6%	3,188,409
Lumber	8.4%	29.0%	1,298,809
Remainder/Composite Paper	8.3%	37.3%	1,286,407
Remainder/Composite Organic	6.1%	43.5%	949,946
Textiles	5.3%	48.8%	818,690
Mixed Residue	4.5%	53.3%	701,789
Leaves and Grass	4.5%	57.8%	689,241
Other Miscellaneous Paper	4.2%	62.0%	657,254
Prunings and Trimmings	3.7%	65.7%	572,973
Bulky Items	3.6%	69.3%	563,079
Total	69.3%		10,726,599

Any differences between *cumulative percent* figures and the sum of *estimated percent* figures are due to rounding. The above table was constructed using sector percentage data obtained from the 2014 vehicle surveys applied to 2014 composition results. See *Special Note Regarding Sector Percentages* on Page 3 for a further explanation of the sector percentage issues.

Recoverability

Composition estimates by Recoverability Group for the franchised residential plus residential self-hauled waste stream are illustrated in Figure 24. The Compost/Mulch group accounted for 42 percent of the waste stream. The Disposed group (29 percent) was the majority of the remaining materials.

Figure 24: Recoverability of Franchised Residential Plus Residential Self-Hauled Disposed Waste

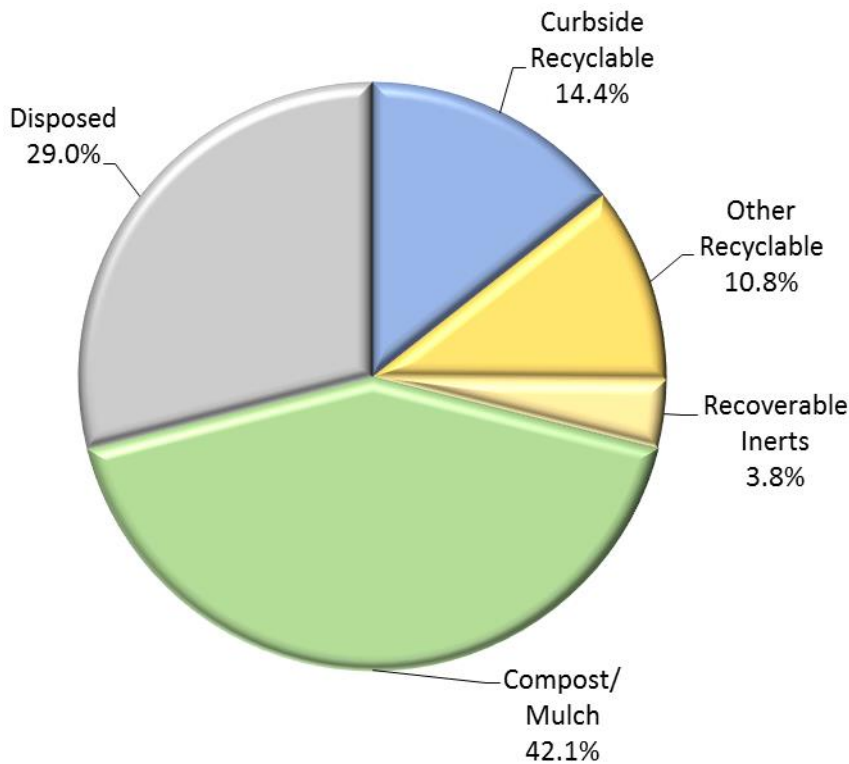

Recoverability Group	Est. Percent
Curbside Recyclable	14.4%
Other Recyclable	10.8%
Recoverable Inerts	3.8%
Compost/Mulch	42.1%
Disposed	29.0%
Total	100%

Numbers may not total exactly due to rounding. See Appendix B: List and Definitions of Material Types for listing of material types in each group.

The above pie chart and table were constructed using sector percentage data obtained from the 2014 vehicle surveys applied to 2014 composition results. See *Special Note Regarding Sector Percentages* on Page 3 for a further explanation of the sector percentage issues.

Detailed Composition

The composition percentages by weight for each *material type* in California's franchised residential plus residential self-hauled waste stream are listed in Table 32. Table 32 presents the 2014 sector percentages applied to the 2014 waste composition data and, for comparison, the sector percentages obtained in the 2008 Statewide Waste Characterization Study applied to the 2014 waste composition data. When comparing compositions from the two sets of data, composition percentages for most materials may be similar, but tonnage amounts can be very different. See *Special Note Regarding Sector Percentages* on Page 3 for a further explanation of the sector percentage issues.

Table 32: Composition of Franchised Residential Plus Residential Self-Hauled Disposed Waste

Material	Est. Using 2014 Sector Percentages			Est. Using 2008 Sector Percentages		
	Estimated Percent	+ / -	Estimated Tons	Estimated Percent	+ / -	Estimated Tons
Paper	18.2%		2,813,413	18.3%		1,876,239
Uncoated Corrugated Cardboard	1.9%	0.5%	299,369	2.0%	0.5%	207,315
Paper Bags	0.3%	0.0%	44,790	0.3%	0.0%	32,440
Newspaper	2.0%	0.9%	306,913	2.0%	1.0%	209,990
White Ledger Paper	0.3%	0.1%	40,919	0.3%	0.1%	27,287
Other Office Paper	0.4%	0.1%	65,862	0.4%	0.1%	40,727
Magazines and Catalogs	0.7%	0.2%	105,178	0.7%	0.1%	69,586
Phone Books and Directories	0.0%	0.0%	6,721	0.0%	0.0%	4,246
Other Miscellaneous Paper	4.2%	0.4%	657,254	4.2%	0.4%	428,384
Remainder/Composite Paper	8.3%	0.8%	1,286,407	8.3%	0.7%	856,265
Glass	2.2%		345,274	2.3%		239,529
Clear Glass Bottles and Containers	1.1%	0.2%	171,422	1.1%	0.2%	116,409
Green Glass Bottles and Containers	0.3%	0.1%	45,206	0.3%	0.1%	26,301
Brown Glass Bottles and Containers	0.4%	0.2%	69,487	0.5%	0.2%	47,522
Other Glass Colored Bottles and Containers	0.0%	0.0%	6,027	0.0%	0.0%	3,797
Flat Glass	0.1%	0.1%	15,786	0.2%	0.1%	16,955
Remainder/Composite Glass	0.2%	0.1%	37,345	0.3%	0.1%	28,545
Metal	3.0%		456,607	3.0%		305,788
Tin/Steel Cans	0.8%	0.1%	129,373	0.9%	0.1%	89,028
Major Appliances	0.2%	0.4%	36,922	0.2%	0.2%	16,391
Used Oil Filters	0.0%	0.0%	683	0.0%	0.0%	569
Other Ferrous	0.7%	0.2%	103,924	0.7%	0.2%	70,826
Aluminum Cans	0.2%	0.0%	29,204	0.2%	0.0%	20,621
Other Non-Ferrous	0.4%	0.1%	65,554	0.4%	0.1%	40,146
Remainder/Composite Metal	0.6%	0.2%	90,947	0.7%	0.2%	68,207
Electronics	1.1%		170,291	1.1%		115,446
Brown Goods	0.3%	0.3%	44,502	0.3%	0.2%	26,384
Computer-related Electronics	0.2%	0.1%	24,954	0.2%	0.1%	17,131
Other Small Consumer Electronics	0.4%	0.1%	56,292	0.4%	0.1%	38,050
Video Display Devices	0.3%	0.2%	44,543	0.3%	0.2%	33,881
Plastic	9.9%		1,531,994	10.1%		1,035,160
PETE Containers	0.7%	0.1%	111,585	0.7%	0.1%	74,934
HDPE Containers	0.5%	0.1%	70,520	0.5%	0.0%	47,303
Miscellaneous Plastic Containers	0.6%	0.1%	92,680	0.6%	0.1%	63,558
Plastic Trash Bags	1.1%	0.1%	171,914	1.1%	0.1%	118,001
Plastic Grocery and Other Merchandise Bags	0.7%	0.1%	115,767	0.8%	0.1%	77,523
Non-Bag Commercial and Industrial Packaging Film	0.1%	0.1%	19,968	0.1%	0.1%	14,818
Film Products	0.0%	0.0%	6,176	0.1%	0.0%	5,517
Other Film	1.9%	0.3%	288,059	2.0%	0.3%	201,561
Durable Plastic Items	1.8%	0.5%	276,042	1.7%	0.4%	172,085
Remainder/Composite Plastic	2.5%	0.3%	379,281	2.5%	0.3%	259,861

Confidence intervals calculated at the 90% confidence level. Percentages for material types may not total 100% due to rounding.

More detailed composition tables can be found in Appendix D: Expanded Statewide Waste Characterization Tables

The above table presents the 2014 sector percentages applied to the 2014 waste composition data and, for comparison, the sector percentages obtained in the 2008 Statewide Waste Characterization Study applied to the 2014 waste composition data. See *Special Note Regarding Sector Percentages* on Page 3 for a further explanation of the sector percentage issues.

Table 32 (continued): Composition of Franchised Residential Plus Residential Self-Hauled Disposed Waste

Material	Est. Using 2014 Sector Percentages			Est. Using 2008 Sector Percentages		
	Estimated Percent	+ / -	Estimated Tons	Estimated Percent	+ / -	Estimated Tons
Other Organic	43.5%		6,725,659	42.5%		4,371,386
Food	20.6%	1.7%	3,188,409	21.1%	1.5%	2,171,890
Leaves and Grass	4.5%	1.6%	689,241	3.6%	1.1%	372,375
Prunings and Trimmings	3.7%	1.5%	572,973	2.8%	1.0%	286,957
Branches and Stumps	1.5%	1.2%	233,242	1.2%	0.8%	119,405
Manures	0.1%	0.1%	17,522	0.2%	0.2%	17,648
Textiles	5.3%	1.1%	818,690	5.6%	1.2%	573,019
Carpet	1.7%	0.7%	255,636	1.7%	0.6%	171,962
Remainder/Composite Organic	6.1%	0.8%	949,946	6.4%	0.8%	658,131
Inerts and Other	13.1%		2,032,742	13.2%		1,352,874
Concrete	1.0%	0.5%	148,598	1.0%	0.5%	99,935
Asphalt Paving	0.0%	0.0%	0	0.0%	0.0%	0
Asphalt Roofing	0.4%	0.5%	68,606	0.3%	0.3%	33,960
Lumber	8.4%	2.7%	1,298,809	8.6%	2.1%	880,146
Gypsum Board	0.5%	0.3%	84,687	0.7%	0.4%	72,259
Rock, Soil and Fines	1.8%	0.6%	278,649	1.5%	0.4%	155,899
Remainder/Composite Inerts and Other	1.0%	0.4%	153,394	1.1%	0.4%	110,675
Household Hazardous Waste (HHW)	0.4%		67,014	0.4%		37,685
Paint	0.2%	0.2%	25,890	0.1%	0.1%	10,692
Vehicle & Equipment Fluids	0.0%	0.0%	219	0.0%	0.0%	88
Used Oil	0.0%	0.0%	749	0.0%	0.0%	374
Batteries	0.1%	0.0%	8,611	0.1%	0.0%	6,986
Remainder/Composite Household Hazardous	0.2%	0.1%	31,546	0.2%	0.1%	19,544
Special Waste	4.0%		623,261	4.5%		459,919
Ash	0.0%	0.0%	4,731	0.0%	0.0%	3,654
Treated Medical Waste	0.2%	0.3%	29,791	0.2%	0.4%	22,977
Bulky Items	3.6%	1.8%	563,079	4.0%	1.5%	411,390
Tires	0.1%	0.1%	13,792	0.1%	0.1%	11,996
Remainder/Composite Special Waste	0.1%	0.0%	11,868	0.1%	0.0%	9,903
Mixed Residue	4.5%		701,789	4.7%		483,014
Totals	100.0%		15,468,045	100.0%		10,277,040
Sample Count	369			369		

Confidence intervals calculated at the 90% confidence level. Percentages for material types may not total 100% due to rounding.

More detailed composition tables can be found in Appendix D: Expanded Statewide Waste Characterization Tables

The above table presents the 2014 sector percentages applied to the 2014 waste composition data and, for comparison, the sector percentages obtained in the 2008 Statewide Waste Characterization Study applied to the 2014 waste composition data. See *Special Note Regarding Sector Percentages* on Page 3 for a further explanation of the sector percentage issues.

Compost/Mulch Quantities

Table 33 and Table 34 group the *material types* that typically can be composted or mulched. *Clean dimensional lumber, clean engineered wood, and clean pallets and crates* are subtypes of lumber that are commonly accepted for composting or mulch applications. The table shows the proportions of each material type in each sector, as well as in the overall waste stream. See Appendix D: Expanded Statewide Waste Characterization Tables for data on the compostable paper and lumber subtypes.

Table 33: Selected Compost/Mulch Material Types, Disposed Composition by Sector

Material Type	Franchised Commercial Composition		Franchised Residential Composition		Self-Hauled Composition		California Overall Composition	
	Est. Using 2014 Sector %	Est. Using 2008 Sector %	Est. Using 2014 Sector %	Est. Using 2008 Sector %	Est. Using 2014 Sector %	Est. Using 2008 Sector %	Est. Using 2014 Sector %	Est. Using 2008 Sector %
Other Miscellaneous Paper - Compostable	0.4%	0.3%	0.2%	0.2%	0.0%	0.0%	0.2%	0.2%
Remainder/Composite Paper - Compostable	7.2%	6.7%	8.0%	8.2%	0.2%	0.2%	6.6%	5.8%
Food	20.1%	18.9%	21.9%	23.4%	0.4%	0.4%	18.1%	16.5%
Leaves and Grass	3.2%	3.2%	4.6%	3.7%	3.0%	3.4%	3.8%	3.4%
Prunings and Trimmings	1.8%	1.7%	3.8%	2.9%	4.5%	5.3%	3.1%	2.8%
Branches and Stumps	1.7%	1.8%	1.5%	1.0%	2.4%	2.8%	1.7%	1.8%
Manures	1.3%	1.2%	0.0%	0.0%	0.5%	0.3%	0.6%	0.7%
Clean Dimensional Lumber	4.2%	4.3%	1.6%	1.2%	5.5%	5.1%	3.2%	3.5%
Clean Engineered Wood	1.8%	1.7%	0.9%	0.6%	4.1%	4.0%	1.7%	1.9%
Clean Pallets and Crates	3.1%	3.7%	0.8%	0.8%	3.9%	4.3%	2.1%	3.0%
Total	44.7%	43.8%	43.1%	42.0%	24.5%	25.7%	41.1%	39.6%

Numbers may not total due to rounding. The above table presents the 2014 sector percentages applied to the 2014 waste composition data and, for comparison, the sector percentages obtained in the 2008 Statewide Waste Characterization Study applied to the 2014 waste composition data. See *Special Note Regarding Sector Percentages* on Page 3 for a further explanation of the sector percentage issues.

Table 34: Selected Compost/Mulch Material Types, Disposed Quantities by Sector

Material Type	Franchised Commercial Composition		Franchised Residential Composition		Self-Hauled Composition		California Overall Composition	
	Est. Using 2014 Sector %	Est. Using 2008 Sector %	Est. Using 2014 Sector %	Est. Using 2008 Sector %	Est. Using 2014 Sector %	Est. Using 2008 Sector %	Est. Using 2014 Sector %	Est. Using 2008 Sector %
Other Miscellaneous Paper - Compostable	42,103	49,958	26,636	17,160	203	251	68,942	67,368
Remainder/Composite Paper - Compostable	858,580	1,027,818	1,158,007	762,167	7,934	11,099	2,024,520	1,801,085
Food	2,390,922	2,898,430	3,181,722	2,161,842	18,535	23,092	5,591,179	5,083,364
Leaves and Grass	377,741	493,850	663,657	343,107	131,527	211,664	1,172,925	1,048,621
Prunings and Trimmings	211,250	266,838	553,083	265,433	197,929	336,242	962,262	868,512
Branches and Stumps	208,413	270,765	211,735	96,134	108,345	177,973	528,493	544,872
Manures	150,455	190,421	3,164	3,224	21,189	21,230	174,808	214,875
Clean Dimensional Lumber	503,772	660,478	227,000	106,700	245,323	322,772	976,096	1,089,951
Clean Engineered Wood	213,246	264,447	126,494	57,325	183,482	249,734	523,223	571,507
Clean Pallets and Crates	365,769	572,509	111,180	76,056	173,123	268,316	650,072	916,881
Total	5,322,251	6,695,514	6,262,677	3,889,149	1,087,591	1,622,373	12,672,519	12,207,036

Numbers may not total due to rounding. The above table presents the 2014 sector percentages applied to the 2014 waste composition data and, for comparison, the sector percentages obtained in the 2008 Statewide Waste Characterization Study applied to the 2014 waste composition data. See *Special Note Regarding Sector Percentages* on Page 3 for a further explanation of the sector percentage issues.

Appendix A: Detailed Methodology

Overview

This appendix describes the major elements of the study methodology, including the initial selection of locations for sampling and surveying, the sampling and surveying procedures, and the data analysis approach.

Planning and carrying out a waste characterization study is challenging. These studies seek to apply pure statistical methods within the real-world limitations imposed by budgetary considerations and the day-to-day operations of solid waste transfer and solid waste disposal sites. This study sought to find the proper balance: a statistically valid analysis that was cost-effective and a process for gathering data that was not disruptive to facility operators or their customers.

Definitions of Regions, Waste Sectors, and Subsectors

Descriptions and definitions of the waste sectors and regions used to stratify data collection for the 2014 study are presented in the following sections.

Selection of Regions

This study divided California into five regions to account for any regional variations in waste composition. A random sampling methodology was used to select the facilities at which data were collected within each region. In addition, three to four extra-large sites were selected in each region for gate surveys only. The stratified sampling plan initially targeted an equal number of samples for each region to ensure that the information collected would be comparable statewide and that it would represent the breadth of communities within the state. The regions are shown graphically in Figure 25, and the counties within each region are cited in Table 35.

For more background on how the regions were defined, see Appendix A of the 1999 Statewide Waste Characterization Study (available at <http://www.calrecycle.ca.gov/publications/Detail.aspx?PublicationID=824>). Some of the regions in this study were modified slightly from the 1999 study, but they match the regions used in the 2008 study.

Figure 25: Regions Considered in the Study



The five regions shown in Figure 25 were defined as follows:

- **Coastal** – included the counties on or near the coast that were not in either the Bay Area or Southern Regions. The Coastal Region is more populated than the rural Mountain Region and has a large agricultural component similar to the Central Valley.
- **Bay Area** – included the counties in the San Francisco Bay Area, which are more metropolitan counties with a strong industrial component in the economy.
- **Southern** – included counties that are strongly industrial with large populations and some agricultural influences.
- **Mountain** – included counties that are primarily rural, with strong agricultural economies, low population density, and a low industrial base.
- **Central Valley** – included counties between the Sierra Nevada Mountains and the Coast Range that have a major agricultural base with important population centers and some manufacturing.

Table 35: Counties in the Five Sampling Regions

Coastal	Bay Area	Southern	Mountain	Central Valley
Del Norte	Alameda	Imperial	Alpine	Butte
Humboldt	Contra Costa	Los Angeles	Amador	Colusa
Lake	Marin	Orange	Calaveras	Fresno
Mendocino	Napa	Riverside	El Dorado	Glenn
Monterey	San Francisco	San Bernardino	Inyo	Kern
San Benito	San Mateo	San Diego	Lassen	Kings
San Luis Obispo	Santa Clara	Ventura	Mariposa	Madera
Santa Barbara	Solano		Modoc	Merced
Santa Cruz	Sonoma		Mono	Placer
			Nevada	Sacramento
			Plumas	San Joaquin
			Sierra	Shasta
			Siskiyou	Stanislaus
			Trinity	Sutter
			Tuolumne	Tehama
				Tulare
				Yolo
				Yuba

Waste Sectors

In each of the five regions, waste was characterized for the three sectors and four subsectors as shown in Figure 26 below.

Figure 26: Overview of Waste Disposal Sectors and Subsectors

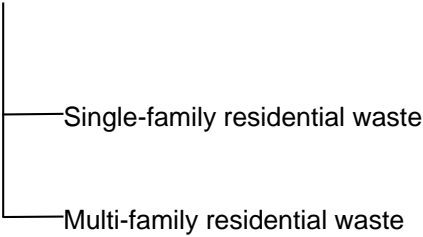
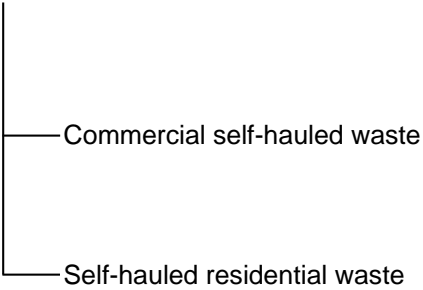
Sector Subsector	Description
Franchised Commercial Waste	Waste disposed by businesses, industries (e.g., factories, farms), institutions, and public areas (e.g., roads, parks) that was collected and transported by contracted or franchised waste haulers, both private and public (municipal).
Franchised Residential Waste 	Waste disposed by households that was collected and transported by contracted or franchised waste haulers, both private and public (municipal). Waste that was collected from either single-family residences or buildings that include no more than four living units. Waste that was collected from multi-unit buildings with greater than four living units.
Self-Hauled Waste 	Waste hauled by individuals, businesses, or government agencies that haul their own garbage; includes waste delivered by anyone other than a contracted, franchised, or municipal hauler. Waste that was hauled to a disposal site by a commercial enterprise (e.g., landscaper, contractor) even if waste is from residential dwellings. Waste that was hauled to a disposal site by a resident from his or her home.

Selection of, Scheduling, and Logistics at Solid Waste Facilities and Multi-Family Sites

A stratified random sampling methodology was used to sample waste from numerous subgroups (strata such as geographical region and waste sector) to develop a waste composition profile for each stratum. The strata were “added together” in a way that reflects each stratum’s relative contribution to the overall waste stream, thus producing overall waste composition information.

Strata considered in this study included the geographical region, the waste sector (residential, commercial, or self-hauled), and the waste subsector (single-family residential, multi-family residential, residential self-hauled, and commercial self-hauled). Waste from the multi-family subsector was sampled at the point of generation (i.e., at multi-family buildings with more than four units). Waste from the other sectors and subsectors was sampled at solid waste facilities.

Waste sampling and the quantification of waste through vehicle surveys occurred during four seasons to account for any seasonal variations in waste disposal patterns. Twelve or 13 sampling and sorting days were scheduled for each season. The sampling/sorting dates were:

- Winter: January–February 2014
- Spring: April 2014
- Summer: July 2014
- Fall: October 2014

Selection and Recruitment of Sites

Solid waste facilities (landfills and transfer stations) for the study were randomly selected from a comprehensive list of facilities in the state. The goal was to recruit five facilities in each region, with the expectation that each facility would be visited twice during periods approximately six months apart. Within each region, potential sorting sites were screened for eligibility based on the following minimum criteria:

- The site handled waste destined for final disposal. For a landfill, this meant waste that was buried; for a transfer station, meant waste that was not subjected to extensive mechanical separation or diversion techniques;
- It was possible to obtain credible tonnage data from all three waste sectors (commercial, residential, and self-hauled) at the site; and
- It was possible to perform waste sampling and sorting at the site.

Solid waste facilities were selected using the steps described below.

- CalRecycle staff assembled a complete list of solid waste facilities in the state that were believed to handle 100 tons or more of waste per day (considering only waste that had not already passed through a waste transfer station or

material recovery facility). Facilities on the list were grouped according to sampling region.

- A random number generator was used to randomize the list of facilities within each region. The first 10 candidate facilities were selected from each region's random-ordered list, for a total of 50 candidate facilities, from which five facilities in each region were to be selected.
- The facilities were then contacted by telephone in the order they appeared on the list. Facility staff were invited to participate in the study and were asked a series of questions as an eligibility screen. Screening criteria were as follows: (1) the facility had to receive an average of at least 100 tons of directly hauled waste per operating day,² (2) an adequate number of vehicles from all waste streams had to be available daily to be sampled, and (3) management had to be willing to accommodate the expected waste sampling and sorting activities.
- Eligible facilities that were interested in participating were assigned alternately to either a spring-fall or a summer-winter sampling schedule, depending on their position on the randomized list. If requested, schedules were adjusted to accommodate operational needs such as construction occurring at the site.
- If a recruited facility was later rejected (see below), the next facility in the randomly sorted list for that region was contacted.

A number of facilities initially contacted were determined to be ineligible because they received a significant amount of material that was processed for recovery. Many of these facilities were not officially named as material recovery facilities (MRFs) but combined both waste transfer and recovery activities. Many rural Mountain Region facilities contacted were fairly small and did not receive many loads from one or more of the desired sectors on any given day. Nevertheless, due to the limited number of sites in the Mountain Region, some of these sites had to be used. In these cases, special arrangements were made to collect samples from all sectors.

Samples were collected and sorted at 26 facilities. Western El Dorado Recovery and MRF (which also houses a transfer station) was used as a replacement sampling facility for Benton Crossing Landfill which was unavailable for the second planned sampling date due to logistical challenges with the site. Table 36 lists all participating sampling facilities.

² This requirement was waived for the Mountain Region as few, if any, of the facilities in that region average 100 tons per day.

Table 36: Participating Sampling Facilities

Region	County	Facility	City	Seasons
Bay Area	Alameda	Fremont Recycling and Transfer Station	Fremont	Winter/Summer
	Contra Costa	Golden Bear Waste Recycling Center	Richmond	Winter/Summer
	San Mateo	Shoreway Environmental Center	San Carlos	Winter/Summer
	Napa	Devlin Road Transfer Station	American Canyon	Spring/Fall
	Alameda	City of Berkeley Transfer Station	Berkeley	Spring/Fall
Coastal	Santa Cruz	Ben Lomond Transfer Station	Ben Lomond	Winter/Summer
	Santa Cruz	City of Santa Cruz Resource Recovery Facility	Santa Cruz	Winter/Summer
	San Luis Obispo	Cold Canyon Landfill	San Luis Obispo	Spring/Fall
	San Luis Obispo	City Of Paso Robles Landfill	Paso Robles	Spring/Fall
	Mendocino	Willits Solid Waste Transfer & Recycling Center	Willits	Spring/Fall
Mountain	Tuolumne	Cal Sierra Transfer Station	Sonora	Winter/Summer
	Mono	Benton Crossing Landfill	Whitmore Hot Springs	Winter
	El Dorado	Western El Dorado Recovery Systems MRF	Placerville	Summer
	Calaveras	Rock Creek Landfill	Milton	Winter/Summer
	Nevada	McCourtney Road Transfer Station	Grass Valley	Spring/Fall
	Mariposa	Mariposa County Sanitary Landfill	Mariposa	Spring/Fall
Southern	Los Angeles	Lancaster Landfill and Recycling Center	Lancaster	Winter/Summer
	Los Angeles	Calabasas Sanitary Landfill	Agoura	Winter/Summer
	San Diego	West Miramar Sanitary Landfill	San Diego	Spring/Fall
	San Bernardino	Victorville Sanitary Landfill	Victorville	Spring/Fall
	Los Angeles	Chiquita Canyon Sanitary Landfill	Castaic	Spring/Fall
Valley	Tehama	Tehama County/Red Bluff Landfill	Red Bluff	Spring/Fall
	San Joaquin	Lovelace Transfer Station	Manteca	Winter/Summer
	Fresno	American Avenue Disposal Site	Tranquility	Winter/Summer
	Kern	Bakersfield Metropolitan SLF (BENA)	Caliente	Spring/Fall
	Butte	Oroville Solid Waste Transfer Station	Oroville	Spring/Fall

Site Scheduling and Logistics

A telephone interview was conducted with personnel at each selected solid waste facility (see questionnaire in Appendix C: Forms Used in the Study). The following information was obtained through this interview:

- Written directions to the facility;
- The facility's days and hours of operation, and whether vehicles were accepted outside of those hours;
- Contact information for the owner of the facility, an employee with the authority to provide permission to use the site, staff to assist in making arrangements for data collection, an on-site contact for logistics information, and a person to be the point of contact on the day of sampling;
- A plan or agreement about the exact location of sampling and sorting operations at the facility;
- Confirmation of the facility's willingness to make a loader available for sample collection;
- A plan for the use of scales and the cooperation of gatehouse personnel to obtain vehicle net weights;
- The number of scalehouses at the facility and the process by which vehicles are directed to the scalehouses (e.g., whether commercial haulers use a gate separate from self-haul or cash customers);
- Approximate daily and weekly load counts and tonnage by waste sector, subsector, and total for the facility;
- Estimated vehicle traffic expected for each sector on each day of the week and the estimated peak time of day for each type of load;
- Specific information about numbers and types of vehicles arriving on weekend days;
- Any rules used for recording the net weight of vehicles and for recording alternate minimum weights for small vehicles;
- Information about existing recycling or recovery operations at the facility, and how the study team may obtain samples of waste after any recycling or recovery operations have already been applied to the waste; and
- Tips about any unusual conditions (e.g., weather, anomalies in traffic patterns) that might affect data collection.

During these conversations, the study team also explained the data collection crew's need for sorting space, assistance from a loader and operator, and access to restrooms and shelter at the facility.

Selecting Multi-Family Sites

Prior to each sampling season, the study team identified apartment buildings and complexes for inclusion in the study and contacted the management of those buildings

to gather information and confirm the suitability of the sites. A multi-family site is defined as a building consisting of five or more dwelling units.

The study team contacted the management at each multi-family site to determine the exact location of each waste container that was to be included in sampling and waste generation measurements. The study team confirmed that access to each waste container was possible early on the morning of sampling or, in some cases, the night before the scheduled sampling day. A specific procedure for accessing the waste was developed for each site.

For sites where the waste containers were not normally accessible during early morning hours (for example, in a locked area), the study team made arrangements to ensure that the sampling crew was granted access without delay when they arrived at the site. If a multi-family site could not provide the required information and guarantee that the waste containers were accessible to the data collection crew at the time indicated, then the site was dropped from inclusion in the study and a replacement site was recruited. The study team also obtained the number of existing and occupied dwelling units at each selected site.

During the winter and spring field seasons, selected multi-family sites generally were within 15 miles of the corresponding solid waste facility where waste sampling and sorting took place. During the summer and fall seasons, multi-family samples were collected and sorted as part of another CalRecycle study that occurred concurrently under this contract. The multi-family sites in the final two seasons were within 30 miles of the solid waste facility used for sorting in the additional task.

Numbers of Samples

The State of California's *Uniform Waste Disposal Characterization Method* (available at <https://www2.calrecycle.ca.gov/WasteCharacterization/General/UniformMethod>) guided the determination of the number of samples to sort from each waste sector in each region of the state. A total of 750 samples were planned to be collected over the course of the study (250 residential samples, 250 commercial samples, and 250 self-hauled samples). The number of samples in each sector was divided evenly among the five regions. The actual number of samples collected through four sampling seasons (as shown in Table 37) was four more than the goal. One extra commercial sample and three extra residential samples—one single-family and two multi-family—were collected.

Table 37: Planned vs. Actual Numbers of Waste Samples

Sector	Planned Number of Samples	Actual Number of Samples
Commercial	250	251
Residential	250	253
<i>Single-family residential</i>	200	201
<i>Multi-family residential</i>	50	52
Self-Hauled	250	250
Total	750	754

Table 38 presents a detailed account of the waste samples that were characterized at each facility, in each region, and in each season.

Table 38: Waste Samples Characterized During the Study

	Season	Winter - Actual				Spring - Actual				Summer - Actual				Fall - Actual				Totals		
		Sector	SF	MF	Com	SH	SF	MF	Com	SH	SF	MF	Com	SH	SF	MF	Com		SH	
Bay Area	Shoreway Environmental Center		3	1	5	5					5			6	5				30	
	Fremont Recycling and Transfer		2	1	5	5					8			8	0				29	
	Golden Bear Waste Rec Cntr		2	1	5	5					7			5	4				29	
	City of Berkeley Transfer Station						3	1	4	5						3		4	8	28
	Devlin Road Transfer Station						4	1	5	5						3		3	8	29
	Additional Multi-Family												6				1			7
Coastal	Willits Solid Waste TS and Rec Cntr						1	1	4	8						7		7	2	30
	City Of Paso Robles Landfill						3	1	5	5						4		7	4	29
	Cold Canyon Landfill						5	1	4	4						4		7	4	29
	City of Santa Cruz Resource Recovery Facility		2	1	4	5					4			5	6					27
	Ben Lomond Transfer Station		4	1	4	6					7			3	6					31
	Additional Multi-Family												3				2			5
Mountain	Benton Crossing Landfill		3	1	6	4														14
	Cal Sierra Transfer Station		3	1	5	5					4			6	5					29
	Rock Creek Landfill		4	1	4	6					6			4	5					30
	McCourtney Road Transfer Station						5	1	1	7						3		8	4	29
	Mariposa County Sanitary Landfill						3	1	7	3						3		3	8	28
	Western El Dorado Recovery Systems MRF										6			7	3					16
Additional Multi-Family												3				2			5	
Southern	Calabasas Sanitary Landfill		3	1	5	5					5			5	5					29
	Lancaster Landfill and Rec Cntr		4	1	5	5					6			5	4					30
	Chiquita Canyon Sanitary Landfill						2	1	5	5						5		5	5	28
	West Miramar Sanitary Landfill						4	1	5	5						4		5	6	30
	Victorville Sanitary Landfill						2	1	5	5						5		5	5	28
	Additional Multi-Family												4				1			5
Valley	American Avenue Disposal Site		3	1	5	5					4			6	5					29
	Lovlace Transfer Station		4	1	5	5					7			5	4					31
	Bakersfield Metropolitan SLF (BENA)						4	1	5	5						3		5	5	28
	Tehama County/Red Bluff Landfill						4	1	4	5						3		8	6	31
	Oroville Solid Waste Transfer Station						5	1	3	5						3		4	5	26
	Additional Multi-Family												3				2			5
Totals		37	12	58	61	45	13	57	67	69	19	65	52	50	8	71	70	754		

Obtaining and Sorting Waste Samples

Sampling at Solid Waste Facilities

Upon arriving at each solid waste site, the team reviewed the sampling plan and sorting requirements with the site's operational staff. They verified the information collected during the telephone interview, including the most suitable area for sorting and the availability of equipment for selecting samples and transporting them to the sorting area.

Diverting Selected Loads

A systematic selection procedure was used to identify the vehicles that provided waste samples at municipal solid waste facilities. A sampling interval for each waste sector was established to calculate vehicle sampling frequency. Sampling intervals were determined by dividing the total number of loads for each sector arriving at the facility each day—estimated from solid waste site interviews—by the number of samples needed each day. The resulting number was the sampling frequency, used to determine whether, for example, every third vehicle, every sixth vehicle, or every twentieth vehicle was selected for sampling. This strategy is termed “selecting every n^{th} vehicle” within a waste sector. See Appendix C: Forms Used in the Study for an example of a *vehicle selection form* that specifies the intervals chosen for a particular day of sampling.

Every time one of the designated n^{th} vehicles in each waste sector arrived, the gate surveyor placed a *sample placard* on the vehicle's windshield or dashboard to identify it as a vehicle intended for sampling, and directed the driver to the sampling area. See Appendix C: Forms Used in the Study for an example of a *sample placard*.

When the sampling crew intercepted the vehicle, the field crew supervisor recorded the information from the sample placard onto the *sample sorting and characterization form* (see Appendix C: Forms Used in the Study). The field crew supervisor also noted any unusual circumstances associated with the load or the sample.

Obtaining Waste Samples, Adequate Sample Weights

Each load selected for sampling was tipped into an elongated pile in the designated area at each solid waste facility. From each selected load, one sample of waste weighing at least 200 pounds was selected based on a systematic “grab” from the perimeter of the load, treating the tipped load as a clock face. For example, if the tipped pile was viewed from the top as a clock face with 12 o'clock being the part of the load closest to the front of the truck, the first sample was taken at the 12 o'clock position. Subsequent samples were collected from 3 o'clock, 6 o'clock, and 9 o'clock. For the next four loads, the extraction point shifted to 1 o'clock, 4 o'clock, 7 o'clock, 10 o'clock, and so on. This concept of systematically rotating around subsequent loads is shown in Figure 27. Samples were removed from the pile either by hand or with the assistance of a loader operator at the site. Samples were then placed on a tarp or in totes.

The specifications for selecting self-hauled samples were slightly different, because self-hauled loads vary greatly in size. A sample of at least 200 pounds was taken only if the entire load weighed more than 250 pounds. For loads weighing between 175 and

250 pounds, the entire load was sorted as a sample. When a load weighed less than 175 pounds, additional loads from the same waste subsector (commercial self-hauled or residential self-hauled) were collected until the total weight exceeded 200 pounds. The combined loads were then sorted as one sample.

Figure 27: Systematic Sampling Procedure for Incoming Loads

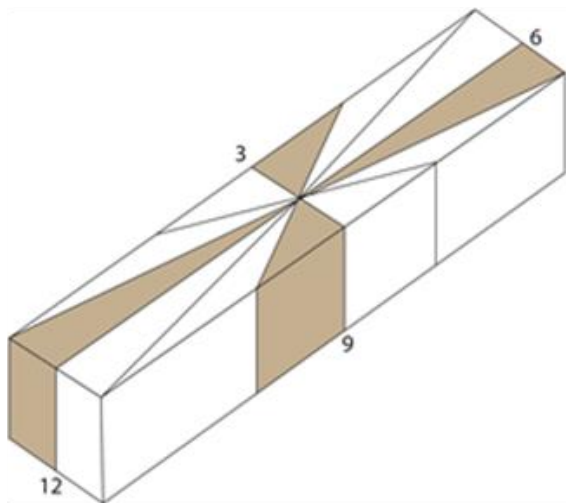

Sampling at Multi-Family Sites

All the waste disposal bins at the site were inspected to determine whether any substantial and obvious differences existed among waste in the bins. In most cases, the waste sample was obtained from a single bin, chosen at random from among those present at the site. If clear differences were apparent in the waste from bin to bin, then subsamples from multiple bins were collected to ensure a representative sample. However, the waste in *all* waste containers associated with the building was measured in order to calculate a waste disposal rate for the entire site.

The volume of waste in each waste container was measured using a tape measure along each dimension, and the dimensions were recorded on a *multi-family site visit form* created specifically for that multi-family site. (See Appendix C: Forms Used in the Study for an example of a *multi-family site visit form*.) Later, the waste disposal rate for each multi-family site was calculated based on the total volume of accumulated waste that was measured, divided by the time elapsed since the most recent waste pickup.

Each waste sample was extracted from the bin by pulling out a vertical cross-section of waste estimated to weigh at least 200 pounds. The sample was loaded into the back of a van, transported to the solid waste site scheduled for that day, and sorted according to the same protocol that was used for samples of waste from other sectors.

Sorting Samples and Recording Data

After a sample was collected and placed on a tarp or in totes, the material was sorted by hand into the prescribed component types. The *material types* are defined in Appendix B: List and Definitions of Material Types. Plastic baskets or tubs were used to hold the separated components. Crew members sorted the contents of each sample and placed each material type in the appropriate or tub, while the field crew supervisor

Figure 28: Sample to be Sorted



monitored the consistency and accuracy of each crew member's work. Crew members typically specialize in groups of *material types*, such as papers or plastics. In addition to manually sorting loads, the sorting crew estimated the percentage of leaves and the percentage of grass, by weight, in the *leaves and grass* material category.

The field crew supervisor monitored the homogeneity of the material that the sorting crew placed into the assigned component tubs, and directed the re-sorting of *material types* if they were improperly classified. Open tubs allowed the supervisor to see the material at all times. Figure illustrates a typical table and tub arrangement.

Figure 29: Sort Table and Tubs



The supervisor also verified the purity of each component as it was weighed, before recording the weight into the *sample sorting and characterization form*. See Appendix C: Forms Used in the Study for an example of a *sample sorting and characterization form*. The *material types* were sorted to the greatest reasonable level of detail by hand, until no more than a small amount of homogeneous fine material (*mixed residue*) remained.

The tubs holding each material category were weighed (accounting for each tub's empty weight) on a set of scales that was calibrated to accuracy within one-tenth of a pound. The field crew supervisor recorded composition weights and the information obtained from the driver on the *sample sorting and characterization form*.

Vehicle Surveys

The ultimate product of the survey data and weekend data was an estimate of the fraction of the overall waste stream contributed by each of the waste sectors, subsectors, and activities at each participating facility. This section describes how sites

were selected and how field data was collected. The Quantifying Disposed Waste section of this appendix describes how this information was then used to estimate the relative magnitude of each part of the disposed waste stream on a regional basis and statewide.

To quantify the waste associated with each sector and subsector, surveys were conducted at the entrance of all 26 participating sampling facilities as well as at an additional 16 survey-only facilities, shown in Table 39. These 16 sites were not randomly selected, but rather chosen from the largest sites in each region. With random selection, large facilities may be completely missed, and large amounts of tonnage in the region may not be represented in the study. To address this, additional large facilities were included in the study for vehicle surveys only. Western El Dorado Recovery and MRF was used as a survey-only facility for the Mountain Region in the winter season. In the summer season it was used as a replacement sampling facility for Benton Crossing Landfill, which was unavailable for the second planned sampling date due to logistical challenges with the site.

Tajiguas Landfill and South Coast Recycling and Transfer Station are two separate facilities near each other in Santa Barbara County. Many of the franchised haulers use Tajiguas landfill, while South Coast Recycling and Transfer Station is used mostly by self-haul customers. The two facilities were surveyed on the same day, with one surveyor at each facility. For the purposes of the analysis, they were treated as a single facility.

Table 39: 16 Survey-Only Facilities

Region	County	Facility	City	Season	2014 Dates
Bay Area	Contra Costa	Contra Costa Transfer Station and Recovery	Martinez	Winter	2/11/14
	Alameda	Davis Street Transfer Station	San Leandro	Spring	5/5/14
	San Mateo	Corinda Los Trancos Landfill	Half Moon Bay	Summer	7/31/14
Coastal	Monterey	Sun Street Transfer Station	Salinas	Winter	2/12/14
	Monterey	Monterey Peninsula Landfill	Marina	Spring	5/2/14
	Santa Barbara	Tajiguas Sanitary Landfill	Goleta	Fall	11/3/14
	Santa Barbara	South Coast Recycling and Transfer Station	Santa Barbara	Fall	11/3/14
Mountain	El Dorado	Western El Dorado Recovery Systems MRF	Placerville	Winter	2/10/14
	Lassen	Bass Hill Landfill	Johnstonville	Summer	8/4/14
	Siskiyou	Yreka Transfer Station	Yreka	Fall	11/5/14
Southern	Los Angeles	Central Los Angeles Recycling and Transfer Station	Los Angeles	Spring	5/8/14
	Los Angeles	Sunshine Canyon Landfill	Sylmar	Summer	7/30/14
	Los Angeles	American Waste Transfer Station	Gardena	Fall	10/31/14
Valley	Fresno	Cedar Avenue Recycling & Transfer Station	Fresno	Winter	2/13/14
	Sacramento	North Area Transfer Station	North Highlands	Spring	5/6/14
	Sacramento	Elder Creek Transfer and Recovery	Sacramento	Summer	8/1/14

The surveys were administered to the drivers of each vehicle entering the facility through the gate at which the surveyor was posted. If the facility had multiple gates, then the surveyor rotated among the gates at regular intervals of approximately one hour. Additional information on weekend disposal patterns was gathered from the facility to supplement survey data for weekdays and to adjust data to better reflect overall disposal at the facility.

On survey days, the surveyor arrived at the site at the scheduled start time, which was scheduled to permit full coverage throughout the day and at times of greatest traffic at

the facility. The surveyor introduced himself or herself to the scalehouse staff and verified the procedure for administering the survey that day by confirming several key details:

- The procedure for obtaining vehicle net weights;
- Any rules the facility used for assigning a minimum net weight to certain types of vehicles, such as those carrying residential self-hauled loads; and
- Any rules governing the assignment of *net volume* estimates instead of net weights.

The surveyor positioned himself or herself at the designated entrance to the facility and interviewed the driver of each passing vehicle. The information gathered through the interview included the following:

- The jurisdiction from which the trash originated;
- The waste sector (residential, commercial, or self-hauled) and subsector (single-family residential, multi-family residential, residential self-hauled, or commercial self-hauled);
- In cases where loads were comprised of waste from multiple sectors, the estimated proportions of the sectors represented in the load;
- The activity that generated the waste; and
- The vehicle type.

An example of the *vehicle survey form* that was used to collect the data is included in Appendix C: Forms Used in the Study.

At most of the facilities, it was possible for the surveyor to obtain net weights for vehicles by observing the weighing process at the scalehouse and recording the weight at the same moment the vehicle drove across the scales. In some cases, the surveyor coordinated with scalehouse personnel periodically throughout the day to obtain weight tickets (transaction receipts) corresponding to every load of waste brought to the facility.

In all cases, the surveyor recorded the type of waste and net weight, net volume, or default assigned weight for every vehicle encountered that was carrying disposed waste that did not come from another solid waste facility. The survey did not record loads of non-disposed waste, material to be recycled or recovered, alternate daily cover, or material brought from transfer stations or other solid waste or recovery facilities. At some facilities, some materials in some self-hauled loads (such as mattresses and scrap metal) are recovered after passing through the scalehouse but before arriving at the disposal area. In these instances, the surveyors, with the help of scalehouse staff, estimated the actual amount disposed from the load.

Sampling and Surveying at Small Facilities

To ensure that small facilities were adequately represented, small sites were given extra attention. Small facilities are those that don't receive enough vehicle traffic to collect the planned number of samples in a single day. A second surveyor traveled ahead of the sampling crew to survey and collect samples (pre-capture) at the small facilities one day before waste sorting occurred, stockpiling those samples for the next day when the sampling crew arrived. The second surveyor collected surveys in between capturing samples.

On the day the sampling crew visited the small facilities, the primary surveyor collected surveys from all vehicles and also identified loads for the sampling crew. This resulted in almost two full days of sampling and surveying for the small facilities, ensuring that an adequate number of samples and surveys was obtained from these smaller facilities.

While the sampling crew was at the small facility, the second surveyor sometimes traveled ahead to begin pre-collection at the next facility, to collect a multi-family sample from the next facility, or to collect additional surveys if the small facility had a second gatehouse.

Data Quality Control

The project team implemented several protocols to ensure the integrity of the data collected in the field. Two of the protocols are listed here.

The data from each season's waste sorts were entered into a database developed prior to the start of sampling. The database permitted entry of the characteristics of the waste load associated with each sample, as well as the weights of the material components in each sample. The data entry fields only permitted values within an expected range; values outside the range were rejected. Material component weights were entered twice, independently, for each sample, and the entered weights were compared to verify that the first entry matched the second entry.

Data collected on the survey forms were checked for accuracy in the field. The surveyor checked the forms at the end of each day to ensure that all appropriate information had been gathered. The project manager checked the surveys after they were returned to the office to confirm that all the required data was properly entered. Survey entries with errors or that were incomplete were not used.

At the end of each data collection season, the data on the survey forms were entered into an Excel workbook. Following data entry, the entries were compared with the written field records. In cases where data entry errors or omissions could not be resolved, the entry was deleted.

Description of Calculations and Statistical Procedures Used

Data from vehicle surveys, facility tonnage reports, and the sorting of waste samples were analyzed to yield estimates of percentages and tonnages of *material types* in California's waste stream. This section describes the methodology used to obtain each estimate and its associated confidence interval (error range).

The general calculation strategy involved two common themes: (1) the use of ratio estimators to determine the composition percentages of the waste stream; and (2) aggregation of sample data from the regional level to the statewide level. A ratio estimator involves the ratio of two quantities, both of which are random variables. For most of the steps in the analysis, the basic ratio estimator was derived as the ratio of the weight of material in a given sample over the total weight of the sample. The general procedure involved creating a new ratio estimator by weighting across ratios from a lower level. For example, statewide ratio estimators were created by weighting the region-level ratio estimators.

Quantifying Disposed Waste

Disposed waste from each sector was quantified through the use of vehicle surveys and tonnage reports at the facilities participating in the study. The calculation method is described below.

Step 1: Aggregating Survey Records to Produce Findings at the Facility Level. For a given facility on a given day, each vehicle that was included in the gatehouse survey had its net weight of waste assigned to one or more of the established waste sectors, according to the response of the driver. Thus, the tonnage from each vehicle was assigned or apportioned to one or more of the franchised commercial, franchised single-family residential, franchised multi-family residential, commercial self-hauled, or residential self-hauled sectors, as well as one of the activity types. The tonnages identified through the survey were used to calculate the relative proportions of the waste stream associated with each sector, subsector, and activity.

Transaction records from facilities supplemented survey data with additional information on the quantities of franchised-collected compared to self-hauled tonnages. All surveys were completed on weekdays, so transaction records for both weekdays and weekend days were requested from all facilities. The study team determined the proportion tonnages on those additional days brought by franchised haulers and by self-hauled vehicles. These estimates were used to improve the overall breakdown between franchised and self-hauled vehicles over the whole week, including weekends. Within the broad categories of franchised and self-hauled loads, survey data were applied to designate tonnage from transaction records to the sectors, subsectors, and activity types. For example, the transaction record tonnage for franchised haulers was assigned to the franchised residential and franchised commercial sectors in the same proportion as had been found on survey days. Because for several sites only weekday survey data were available, weekend tonnage from transaction records within a category (franchised or self-hauled) was designated to a sector or subsector (i.e. franchised commercial, franchised single-family, and franchised multi-family) using the weekday proportions. The weekend information improves the overall proportion estimates by providing a more accurate picture of the breakdown between franchised and self-haulers on weekends. While most tonnage is brought by franchised haulers on weekdays, tonnage from self-hauled vehicles is typically higher on weekend days. The method is described below:

1. Using survey data from all days (weekday and weekend), the relative proportion of waste brought by franchised haulers assigned to each relevant sector and subsector and the relative proportion of waste brought by self-hauled vehicles assigned to each relevant subsector (commercial self-hauled, residential self-hauled) were estimated.
2. These proportions were applied to the franchised and self-hauled tonnages from transaction records for weekdays and weekend days separately to derive additional “days” of data with an actual category tonnage (from transaction records) and estimated sector and subsector tonnages.
3. The tonnages from survey days and additional days were summed for each facility, by weekday and weekend day, and then divided by the total number of “days” of data to derive an average weekday and average weekend day for each facility.

The projection of waste tonnage for an average weekday, based on the vehicle survey and supplementary information, was scaled up by the number of weekdays per week a given facility is open (typically five) to produce an estimate of tonnages for each type of waste for all weekdays during a given week.

Similarly, the projection of waste tonnage for an average weekend day, based on the vehicle survey and supplementary information, was scaled up by the number of weekend days a given facility is open to produce an estimate of tonnages for each type of waste for all weekend days a waste facility was open during a given week.

The weekday and weekend day tonnages were summed to produce a composite set of estimates of the amount of waste from each sector, subsector, and activity arriving at the solid waste facility over a representative week. These tonnages were converted to relative proportions (percentages).

Each facility’s tonnage figures for direct-haul disposed waste were obtained or estimated for the calendar year 2013 (the most recent year for which data was available during the 2014 study period). This information was obtained from the facilities themselves, from county databases, or from information reported to CalRecycle through landfill or station reports as part of the Disposal Reporting System. The relative proportions described above were applied to these figures to produce estimates of the tons of direct-haul disposed waste associated with each sector, subsector, and activity at the facility in question.

Example of Estimating Sector Proportions at the Facility Level

For example, imagine that Facility A was visited on two weekdays. Suppose that Facility A also provided transaction records for one additional weekday and one additional weekend day (though the field crew was not present on those days). The following scenario describes how the percentages of waste for each sector and subsector were calculated for this facility. Example numbers are rounded and decimals are not carried through calculations. To make the examples easier to format and read, the activity types are not shown in the examples tables. However, the tonnage associated with each

activity type (including the C&D activities) was calculated using the same method outlined in the following examples.

First, survey data from the facility for the two weekdays the study crew was present were examined to determine the tons associated with the studied sectors and subsectors.

	Franchised			Self-Hauled		Total
Facility A	Commercial	Single-Family Residential	Multi-Family Residential	Commercial Self-Hauled	Residential Self-Hauled	
Surveyed Tonnage from Weekday 1	20	20	20	15	15	90
Surveyed Tonnage from Weekday 2	30	15	25	20	10	100
Tonnage for Two Weekdays	50	35	45	35	25	190

Next, the tonnages were converted into percentages within the franchised and self-hauled categories, as shown below.

	Franchised				Self-Hauled		
Facility A	Commercial	Single-Family Residential	Multi-Family Residential	Total	Commercial Self-Hauled	Residential Self-Hauled	Total
Tonnage for Two Weekdays	50	35	45	130	35	25	60
Percentages	38%	27%	35%	100%	58%	42%	100%

These percentages were then applied to the franchised and self-hauled tonnages from additional day transaction records supplied by the facility.

	Franchised			Self-Hauled	
Facility A	Commercial	Single-Family Residential	Multi-Family Residential	Commercial Self-Hauled	Residential Self-Hauled
Tonnage from Additional Weekday Records	75			20	
	$75 \times 0.38 = 29$	$75 \times 0.27 = 20$	$75 \times 0.35 = 26$	$20 \times 0.58 = 12$	$20 \times 0.42 = 8$
Tonnage from Additional Weekend Day Records	30			100	
	$30 \times 0.38 = 11$	$30 \times 0.27 = 8$	$30 \times 0.35 = 11$	$100 \times 0.58 = 58$	$100 \times 0.42 = 42$

The calculated daily tonnages were averaged to create typical weekdays and weekend days. First, the average weekday tonnage was calculated from the three weekday

tonnage numbers calculated above. Next, the average weekday tonnage was multiplied by the number of weekdays the facility is open. The process was repeated for the weekend days using weekend day tonnage information. An average week was then constructed by summing the weekday tonnage number and the weekend day tonnage number. For this example, suppose that Facility A operates from Monday through Saturday, or five weekdays and one weekend day.

Facility A	Franchised			Self-Hauled	
	Commercial	Single-Family Residential	Multi-Family Residential	Commercial Self-Hauled	Residential Self-Hauled
Average Weekday Tonnage	$(20+30+29)/3$ =26	$(20+15+20)/3$ =18	$(20+15+26)/3$ =24	$(15+20+12)/3$ =16	$(15+10+8)/3$ =11
Average Weekend Day Tonnage	$(11)/1$ =11	$(8)/1$ =8	$(11)/1$ =11	$(58)/1$ =58	$(42)/1$ =42
Average Weekly Tonnage	$(26*5)+(11*1)$ =141	$(18*5)+(8*1)$ =98	$(24*5)+(11*1)$ =131	$(16*5)+(58*1)$ =138	$(11*5)+(42*1)$ =97

The average weekly tonnage for each facility was converted to percentages for each sector and subsector and then multiplied by the total tons of direct haul waste disposed by that facility in 2013, according to data from CalRecycle's Disposal Reporting System or other data as described above. Suppose that Facility A accepted 500,000 tons of direct haul waste in 2013. The amounts assigned to each sector and subsector are shown in the table below.

Facility A	Franchised			Self-Hauled		Total
	Commercial	Single-Family Residential	Multi-Family Residential	Commercial Self-Hauled	Residential Self-Hauled	
Average Weekly Tonnage	141	98	131	138	97	605
Percentage of Facility Tonnage	23%	16%	22%	23%	16%	100%
Annual Tonnage	115,000	80,000	110,000	115,000	80,000	500,000

Step 2: Aggregating Tonnage from Facilities to Produce Findings at the Regional Level. Tonnage estimates for each type of waste were combined for participating facilities within each region, using a weighted averaging method. The tonnage estimates for each type of waste at all participating facilities within a region were aggregated, and relative proportions were calculated for each sector and subsector. The aggregated proportions for each sector and subsector were then applied to the total 2013 disposal figure for amounts disposed at landfills in the region, as drawn from the Disposal Reporting System.

For example, hypothetical annual tonnages by subsector for two facilities visited in a region are shown in the table below.

	Commercial	Single-Family Residential	Multi-Family Residential	Commercial Self-Hauled	Residential Self-Hauled	Total
Facility A	115,000	80,000	110,000	115,00	80,000	500,000
Facility B	150,000	80,000	10,000	30,000	5,000	275,000
Total (tons)	265,000	160,000	120,000	145,000	85,000	775,000
% of Total	34%	21%	15%	19%	11%	100%

Using an annual tonnage for this region of 2,000,000 tons, we can assign tonnages to sectors, subsectors, and activities according to the percentages from the survey data.

Region 1	Commercial	Single-Family Residential	Multi-Family Residential	Commercial Self-Hauled	Residential Self-Hauled	Total
Percent	34%	21%	15%	19%	11%	100%
Tons	680,000	420,000	300,000	380,000	220,000	2,000,000

Step 3: Aggregating Regional Findings to Produce Sector Tonnage Estimates Statewide. The relative proportions of disposed waste corresponding to each sector were combined among regions using a weighted aggregation method. The weightings associated with each region were proportional to the total disposed tonnage for the region for calendar year 2013. This step resulted in a final set of proportions reflecting the relative disposal of waste corresponding to each waste sector statewide. The proportions were then multiplied by the total 2013 statewide disposal figure to produce the statewide tonnage estimate associated with each sector.

The 2013 figures for disposed tonnage associated with each region, as drawn from the Disposal Reporting System, are shown in Table 40.

Table 40: Total Waste Disposal (Tons) in Each County and Region, 2013

Bay Area		Coastal		Mountain		Southern		Central Valley	
Alameda	1,403,299	Del Norte	0	Alpine	0	Imperial	203,516	Butte	136,262
Contra Costa	758,062	Humboldt	0	Amador	0	Los Angeles	6,909,762	Colusa	248
Marin	181,105	Lake	61,407	Calaveras	31,848	Orange	3,604,575	Fresno	439,413
Napa	27,474	Mendocino	0	El Dorado	1,641	Riverside	3,201,826	Glenn	20,073
San Francisco	0	Monterey	618,657	Inyo	19,194	San Bernardino	1,135,422	Kern	817,935
San Mateo	488,447	San Benito	124,312	Lassen	18,043	San Diego	2,938,443	Kings	451,773
Santa Clara	840,086	San Luis Obispo	261,239	Mariposa	11,438	Ventura	1,030,894	Madera	142,217
Solano	764,821	Santa Barbara	309,370	Modoc	0			Merced	259,948
Sonoma	166,874	Santa Cruz	138,167	Mono	19,879			Placer	215,987
				Nevada	0			Sacramento	722,311
				Plumas	0			San Joaquin	1,146,315
				Sierra	2,461			Shasta	256,777
				Siskiyou	0			Stanislaus	378,601
				Trinity	0			Sutter	0
				Tuolumne	0			Tehama	45,281
								Tulare	199,221
								Yolo	169,681
								Yuba	189,973
Totals:	4,630,168		1,513,153		104,504		19,204,438		5,592,017
	15.0%		4.9%		0.3%		61.6%		18.1%
						Total Statewide: 30,864,279 tons			

Source: CalRecycle Disposal Reporting System. Counties showing 0 tons disposed do not have local solid waste facilities and send waste to other counties.

Special Note Regarding Vehicle Surveys and Quantifying Waste

Sites participating in the composition study were selected at random from all eligible sites throughout the state. Three large sites in each region not selected for samples were selected as additional survey sites. The actual participation of any site was subject to the site meeting the recruitment criteria listed in the Selection and Recruitment of Sites section. This site selection method ensured that the samples selected were representative of the materials disposed throughout the state. This site selection method also ought to have ensured survey data that accurately represented the proportion of waste disposed by each sector, subsector, and activity. However, various factors—including franchise agreements, flow control, variable tip fees, site operations (some sites do not accept self-hauled (“public”) waste), and sites closing early once their permitted capacities have been reached—can create a market where waste from each sector within a jurisdiction may be tipped at different facilities. The random facility selection for this study appears to have selected facilities that may not accurately represent the proportion of waste disposed by each sector in the Southern Region.

Figure 30 summarizes the tonnage by sector for the statewide waste characterization studies from 1995 through 2014. Historically, as shown in the figure, the commercial sector was consistently near 50 percent of the disposed waste and the residential sector was near 30 percent. At the facilities selected randomly for the current study, those proportions were reversed; the commercial sector accounted for approximately 39 percent of the disposed waste and the residential sector made up approximately 47 percent of the disposed waste. This increase in the residential sector was largely driven by waste from the franchised single-family subsector.

Figure 30: Estimated Contribution of Each Sector to California’s Overall Disposed Waste Stream, 1995–2014

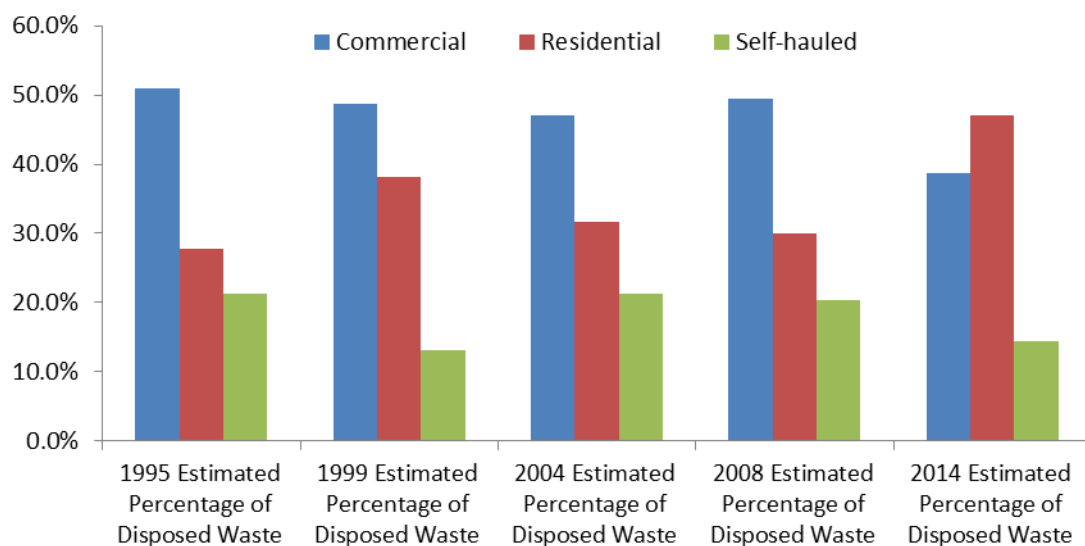

The proportion of disposal generated by the commercial sector was variable over time, as to be expected; however, the Southern Region proportion declined dramatically from past studies—from 54 percent in 2008 to 39 percent in 2014. The large decline in the Southern Region greatly influences the statewide data due to the effect of weighting the regional proportions to calculate the statewide proportions (as described in Step 3 of the preceding Quantifying Disposed Waste section). The Southern Region accounted for more than 60 percent of disposal statewide, so even minor changes in the Southern Region were noticeable at the statewide level. By contrast, the Coastal Region (which experienced an increase in the commercial proportion from 2008 to 2014) accounted for about 5 percent of statewide disposal, so even large changes in the Coastal Region had a relatively small influence at the statewide level. The proportion of disposal generated by the commercial sector in each region for past studies is illustrated in Figure.

Figure 31: Contribution of the Commercial Sector to Disposal by Region, 2004–2014

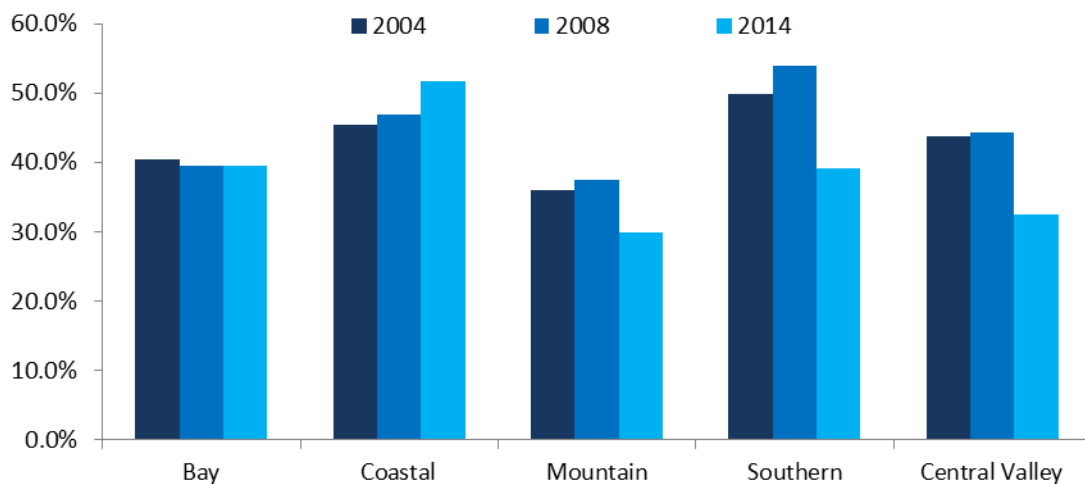

In summary, the commercial proportion of the statewide disposed waste remained relatively stable from 1995 through 2008. Historically, the commercial proportion of the regional waste stream exhibited reasonably small changes from study to study in all regions, except in the Southern Region from 2008 to 2014. This led the project team to further investigate the Southern Region survey data to ascertain if the change in the commercial proportion was “real” (i.e. an actual trend not due to sampling error or bias) or an artifact of the site selection or survey strategy.

The project team first compared the commercial disposal proportion at facilities in the Southern Region that participated in the study over multiple years. Two facilities from the 2004 study and one facility from the 2008 study were repeated in 2014. The proportion of disposal from the commercial sector at those facilities did not vary enough from study year to study year to suggest that the drop in the commercial sector disposal was “real.” The commercial sector proportions at the repeated facilities are not noted here to protect the facilities’ confidential data.

The project team next investigated the proportion of the total Southern Region disposal at the selected facilities. In 2008 the field crew completed surveys at facilities that handle more than 30 percent of the Southern Region disposal. In 2014 the field crew completed surveys at facilities that handle less than 20 percent of the Southern Region disposal. This indicates that it is possible that the facility selection missed the facilities that handle the majority of the commercial waste in the region. The findings are summarized in Table 41.

Table 41: Regional Disposal at Surveyed Facilities

Total Facilities Statewide	2004 22 Facilities	2008 40 Facilities	2014 41 Facilities
Number of Surveyed Facilities in Southern Region	5	8	8
Percent of Southern Region Disposal at Surveyed Facilities	13.1%	31.8%	18.4%

Past studies included surveying at Puente Hills Landfill in the City of Industry. Puente Hills was the largest operating landfill in the country and received nearly 10 percent of the disposed waste in the entire state of California and about 15 percent of the disposed waste in the Southern Region, including a very large share of the region’s commercial disposal. In 2013, prior to the commencement of field work for this project, Puente Hills closed, and that commercial tonnage was dispersed to several nearby facilities. None of those nearby facilities were surveyed as part of this study.

Following a similar process, it appears that two of the facilities selected in the Southern Region received a disproportionate quantity of the region’s residential waste. These facilities received nearly all of the residential waste for the city of Los Angeles and much less tonnage from the other generating sectors. Therefore, when gate survey data were aggregated, these two sites further skewed the sector proportions toward residential waste.

The combination of the “missing” Puente Hills commercial tonnage and the overrepresented residential waste at two facilities indicated to the project team that the initial estimate of commercial tonnage in the Southern Region (and consequently statewide) was too low.

As a first step in correcting for the “missing” franchised commercial tons, the sector tonnage estimates for the Southern Region were calculated without the two disproportionately residential sites. The sector tonnage estimates were then calculated for the two disproportionately residential sites, which were treated as their own region (Region X). The sector tonnage estimates for the Southern Region and for Region X were summed to estimate tons from each sector for the composite Southern Region. Then data from the composite region was aggregated with the other regions to estimate

the statewide sector quantities according to the protocol defined in the Quantifying Disposed Waste section.

In an attempt to better trace the franchised commercial waste flows in the Southern Region, the project team completed phone interviews and reviewed scalehouse records with several facilities around the Southern Region. While very helpful, this additional information did not identify any particular large sites receiving the “missing” franchised commercial tonnage in the Southern Region and served to illustrate the complicated flows of waste in such a large urban area. Due to time and budget constraints, further investigation and data collection by CalRecycle staff to address this issue will need to take place after the project and contract completion. At this time, the project team’s best estimates of tonnage amounts for each sector are included in this report.

Estimating Waste Composition

Waste composition estimates were calculated using a method that gave equal weighting or “importance” to each sample within a given stratum. Confidence intervals (error ranges) were calculated based on assumptions of normality in the composition estimates. For the commercial sector and overall composition estimates, the commercial sector was subdivided into large and small vehicle subsectors. Packer trucks were considered large vehicles, and roll-off boxes were considered small vehicles. Typically, roll-off boxes are lighter than packer trucks, but they dump in approximately equal numbers. The commercial sector was divided to correct for this disparity between the number of roll-off boxes and their tonnage contribution to the waste stream.

In the descriptions of calculation methods, the following variables are used frequently:

- i denotes an individual sample;
- j denotes the material type;
- c_j is the weight of the material type j in a sample;
- w is the weight of an entire sample;
- r_j is the composition estimate for material j (r stands for *ratio*);
- a denotes a region of the state (a stands for *area*);
- s denotes a particular sector or subsector of the waste stream; and
- n denotes the number of samples in the particular group that is being analyzed at that step.

Estimating the Composition

The following method was used to estimate the composition of waste belonging to the single-family residential, multi-family residential, commercial, commercial self-hauled, and residential self-hauled sectors.

For a given stratum (that is, for the samples belonging to the same waste sector within the same region), the composition estimate denoted by r_j represents the ratio of the component’s weight to the total weight of all the samples in the stratum. This estimate was derived by summing each component’s weight across all of the selected samples

belonging to a given stratum and dividing by the sum of the total weight of waste for all of the samples in that stratum, as shown in the following equation:

$$r_j = \frac{\sum_i c_{ij}}{\sum_i w_i} \quad (1)$$

where:

- c = weight of particular component;
- w = sum of all component weights;
- for $i = 1$ to n , where n = number of selected samples; and
- for $j = 1$ to m , where m = number of components.

For example, the following simplified scenario involves three samples. For the purposes of this example, only the weights of the component *carpet* are shown.

	Sample 1	Sample 2	Sample 3
Weight (c) of Carpet	5	3	4
Total Sample Weight (w)	80	70	90

$$r_{Carpet} = \sum \frac{5 + 3 + 4}{80 + 70 + 90} = 0.05$$

To find the composition estimate for the component *carpet*, the weights for that material are added for all selected samples and divided by the total sample weights of those samples. The resulting composition is 0.05, or 5 percent. In other words, 5 percent of the sampled material by weight is *carpet*. This finding is then projected onto the stratum being examined in this step of the analysis.

The confidence interval for this estimate was derived in two steps. First, the variance around the estimate was calculated, accounting for the fact that the ratio included two random variables (the component and total sample weights). The variance of the ratio estimator equation follows:

$$\text{Var}(r_j) \approx \left(\frac{1}{n} \right) \left(\frac{1}{\bar{w}^2} \right) \left(\frac{\sum_i (c_{ij} - r_j w_i)^2}{n-1} \right) \quad (2)$$

where:

$$\bar{w} = \frac{\sum_i w_i}{n} \quad (3)$$

(For more information regarding Equation 2, refer to *Sampling Techniques, 3rd Edition* by William G. Cochran [John Wiley & Sons, Inc., 1977].)

Second, precision levels at the 90 percent confidence level were calculated for a component's mean as follows:

$$r_j \pm (z\sqrt{\text{Var}(r_j)}) \quad (4)$$

where z = the value of the z -statistic (1.645) corresponding to a 90 percent confidence level.

Composition results for strata were then combined, using a weighted averaging method, to estimate the composition of larger portions of the waste stream. The relative tonnages associated with each stratum served as the weighting factors. The calculation was performed as follows:

$$O_j = (p_1 * r_{j1}) + (p_2 * r_{j2}) + (p_3 * r_{j3}) + \dots \quad (5)$$

where:

- p = the proportion of tonnage contributed by the noted waste stratum (the weighting factor);
- r = ratio of component weight to total waste weight in the noted waste stratum (the composition percent for the given material component); and
- for $j = 1$ to m , where m = number of material components.

For example, the above equation is illustrated here using three waste strata.

	Stratum 1	Stratum 2	Stratum 3
Ratio (r) of Carpet	5%	10%	10%
Tonnage	25,000	100,000	50,000
Proportion of Tonnage (p)	14.3%	57.1%	28.6%

To estimate the portion of larger portions of the waste stream, the composition results for the three strata are combined as follows.

$$O_{Carpet} = (0.143 * 0.05) + (0.571 * 0.10) + (0.286 * 0.10) = 0.093 = 9.3\%$$

Therefore, 9.3 percent of this examined portion of the waste stream is *carpet*.

The variance of the weighted average was calculated as follows:

$$\text{Var}(O_j) = (p_1^2 \text{Var}(r_{j1})) + (p_2^2 \text{Var}(r_{j2})) + (p_3^2 \text{Var}(r_{j3})) + \dots \quad (6)$$

Estimating Composition of Entire Statewide Disposed Waste Stream

Composition results for all waste sectors were combined, using a weighted averaging method, to estimate the composition of the entire statewide disposed waste stream. The relative tonnages associated with each sector served as the weighting factors. The calculation was performed as follows:

$$O_j = (p_1 * r_{j1}) + (p_2 * r_{j2}) + (p_3 * r_{j3}) + \dots \quad (7)$$

where:

- p = the proportion of tonnage contributed by the noted waste sector (the weighting factor);
- r = ratio of component weight to total waste weight in the noted waste sector (the composition percent for the given material component); and
- for $j = 1$ to m , where m = number of material components.

The following scenario illustrates the above equation. This example involves the component *carpet* in three waste sectors.

	Waste Sector 1	Waste Sector 2	Waste Sector 3
Ratio of Carpet (r)	0.05	0.10	0.15
Proportion of Tonnage (p)	0.50	0.25	0.25

$$O_{Carpet} = (0.50 * 0.05) + (0.25 * 0.10) + (0.25 * 0.15) = 0.0875$$

So, it is estimated that 0.0875 or 8.75% of the entire waste stream is composed of *carpet*.

The variance of the weighted average was calculated as follows:

$$\text{Var}(O_j) = (p_1^2 \text{Var}(r_{j1})) + (p_2^2 \text{Var}(r_{j2})) + (p_3^2 \text{Var}(r_{j3})) + \dots \quad (8)$$

Table 42 shows the weighting factors that result when both 2014 and 2008 survey data are applied to the 2014 tons for each region. These factors were applied to 2014 regional composition data, and the regional data was aggregated to the statewide level for each sector and subsector, and for the overall waste stream.

Table 42: Tons by Sector and Region, Calculated Using 2014 and 2008 Survey Data

Region	Single-Family	Multi-Family	Commercial Large	Commercial Small	Commercial Self-Hauled	Residential Self-Hauled	Total
2014							
Bay Area	1,468,856	428,342	1,389,588	439,698	742,295	161,389	4,630,168
Coastal	400,325	154,519	552,213	223,214	138,081	44,800	1,513,153
Mountain	44,663	5,077	27,600	3,755	11,881	11,529	104,504
Southern Valley	6,625,597	2,511,110	5,804,661	1,652,629	1,943,426	487,014	19,024,438
Total	10,924,313	3,591,900	9,039,214	2,870,724	3,486,297	951,833	30,864,279
2008							
Bay Area	1,537,243	359,605	1,168,488	658,787	755,085	150,960	4,630,168
Coastal	429,409	60,020	472,079	237,408	211,220	103,016	1,513,153
Mountain	34,234	1,329	29,674	9,515	15,049	14,703	104,504
Southern Valley	2,677,652	1,936,716	7,384,682	2,864,015	3,656,118	505,255	19,024,438
Total	6,662,188	2,591,814	10,655,613	4,645,879	5,285,747	1,023,039	30,864,279

Appendix B: List and Definitions of Material Types

Introduction

The list and definitions of the Standard Material Types were drawn from CalRecycle's Uniform Waste Disposal Characterization Method (available at <https://www2.calrecycle.ca.gov/WasteCharacterization/General/UniformMethod/>). Currently, the Standard list consists of 62 material types—the same 62 material types used in the 2008 study. Detailed composition tables in the main body of the report are presented using this Standard list. However, samples were sorted and characterized based on an expanded list of 82 material types in 2014, down from an expanded list of 85 in 2008.

Both the Standard list and the expanded list have changed over time as some materials become less prevalent in the waste stream and others become of more interest, but enough consistency has been maintained to allow comparison of data over time. The expanded list of material types is designed to be “folded up” into the Standard list of 62 used for presenting results in this study and provides additional detail on materials of interest to CalRecycle.

Table 43 shows how the 82 materials that are used to sort and characterize the waste stream are “folded up” into the Standard list used in the main report. Following the materials table, this appendix also contains the section Definitions of Material Types (Expanded List).

Expanded and Standard List of Material Types

Table 43: Comparison Between the 2014 Standard List and the 2014 Expanded List

Category	2014 Standard Material List	2014 Expanded Material List	
Paper	Uncoated Corrugated Cardboard	Uncoated Corrugated Cardboard	
	Paper Bags	Paper Bags	
	Newspaper	Newspaper	
	White Ledger Paper	White Ledger Paper	
	Other Office Paper	Other Office Paper	
	Magazines and Catalogs	Magazines and Catalogs	
	Phone Books and Directories	Phone Books and Directories	
	Other Miscellaneous Paper	Other Miscellaneous Paper - Compostable Other Miscellaneous Paper - Other	
	Remainder/Composite Paper		Remainder/Composite Paper - Rigid Food and Beverage Cartons
			Remainder/Composite Paper - Compostable Remainder/Composite Paper - Other
Glass	Clear Glass Bottles and Containers	Clear Glass Bottles and Containers - CRV Clear Glass Bottles and Containers - Non-CRV	
	Green Glass Bottles and Containers	Green Glass Bottles and Containers - CRV Green Glass Bottles and Containers - Non-CRV	
	Brown Glass Bottles and Containers	Brown Glass Bottles and Containers - CRV Brown Glass Bottles and Containers - Non-CRV	
	Other Colored Glass Bottles and Containers	Other Colored Glass Bottles and Containers - CRV	
		Other Colored Glass Bottles and Containers - Non-CRV	
	Flat Glass	Flat Glass	
Remainder/Composite Glass	Remainder/Composite Glass		
Metal	Tin/Steel Cans	Tin/Steel Cans - CRV Bimetal Containers Tin/Steel Cans - Other	
	Major Appliances	Major Appliances	
	Used Oil Filters	Used Oil Filters	
	Other Ferrous	Other Ferrous	
	Aluminum Cans	Aluminum Cans - CRV	
		Aluminum Cans - Non-CRV	
	Other Non-Ferrous	Other Non-Ferrous	
Remainder/Composite Metal	Remainder/Composite Metal		
Electronics	Brown Goods	Brown Goods	
	Computer-Related Electronics	Computer-Related Electronics	
	Other Small Consumer Electronics	Other Small Consumer Electronics	
	Video Display Devices	Video Display Devices - CRT	
Video Display Devices - Other			

Table 43 (continued)

Category	2014 Standard Material List	2014 Expanded Material List
Plastic	PETE Containers	PETE Containers - CRV PETE Containers - Non-CRV
	HDPE Containers	HDPE Containers - CRV HDPE Containers - Non-CRV
	Miscellaneous Plastic Containers	Miscellaneous Plastic Containers - CRV Miscellaneous Plastic Containers - Non-CRV
	Plastic Trash Bags	Plastic Trash Bags
	Plastic Grocery and Other Merchandise Bags	Plastic Grocery and Other Merchandise Bags
	Non-Bag Commercial and Industrial Packaging Film	Non-Bag Commercial and Industrial Packaging Film
	Film Products	Film Products
	Other Film	Other Film - Flexible Plastic Pouches Other Film - Other
	Durable Plastic Items	Durable Plastic Items - #3-#5 Bulky Rigids Durable Plastic Items - Other
Remainder/Composite Plastic	Remainder/Composite Plastic	
Other Organic	Food	Food
	Leaves and Grass	Leaves and Grass
	Prunings and Trimmings	Prunings and Trimmings
	Branches and Stumps	Branches and Stumps
	Manures	Manures
	Textiles	Textiles
	Carpet	Carpet
Remainder/Composite Organic	Remainder/Composite Organic	
Inerts and Other	Concrete	Concrete
	Asphalt Paving	Asphalt Paving
	Asphalt Roofing	Asphalt Roofing
	Lumber	Clean Dimensional Lumber Clean Engineered Wood Clean Pallets and Crates Other Wood Waste
	Gypsum Board	Gypsum Board
	Rock, Soil and Fines	Rock, Soil and Fines
Remainder/Composite Inerts and Other	Remainder/Composite Inerts and Other	

Table 43 (continued)

Category	2014 Standard Material List	2014 Expanded Material List
Household Hazardous	Paint Vehicle & Equipment Fluids Used Oil Batteries	Paint Vehicle & Equipment Fluids Used Oil Batteries
	Remainder/Composite Household Hazardous	Mercury-Containing Items - Not Lamps Lamps - Fluorescent and LED Remainder/Composite Household Hazardous
Special Waste	Ash	Ash
	Treated Medical Waste	Treated Medical Waste
	Bulky Items	Bulky Items
	Tires	Tires
	Remainder/Composite Special Waste	Remainder/Composite Special Waste
Mixed Residue	Mixed Residue	Mixed Residue

Table 44: Materials Organized by Recoverability Group

Curbside Recyclable	Other Recyclable	Recoverable Inerts
Uncoated Corrugated Cardboard	Major Appliances	Concrete
Paper Bags	Used Oil Filters	Asphalt Paving
Newspaper	Other Ferrous	Asphalt Roofing
White Ledger Paper	Other Non-Ferrous	Gypsum Board
Other Office Paper	Computer-Related Electronics	Rock, Soil and Fines
Magazines and Catalogs	Other Small Consumer Electronics	
Phone Books and Directories	Video Display Devices - CRT	Disposed
Other Miscellaneous Paper - Other	Video Display Devices - Other	Remainder/Composite Paper - Rigid Food & Beverage Cartons
Clear Glass Bottles and Containers - CRV	Plastic Grocery and Other Merchandise Bags	Remainder/Composite Paper - Other
Clear Glass Bottles and Containers - Non-CRV	Non-Bag Commercial and Industrial Packaging Film	Flat Glass
Green Glass Bottles and Containers - CRV	Durable Plastic Items - #2 and #5 Bulky Rigids	Remainder/Composite Glass
Green Glass Bottles and Containers - Non-CRV	Textiles	Remainder/Composite Metal
Brown Glass Bottles and Containers - CRV	Carpet	Brown Goods
Brown Glass Bottles and Containers - Non-CRV	Paint	Plastic Trash Bags
Other Colored Glass Bottles and Containers - CRV	Vehicle and Equipment Fluids	Film Products
Other Colored Glass Bottles and Containers - Non-CRV	Used Oil	Other Film - Flexible Plastic Pouches
Tin/Steel Cans - CRV Bimetal Containers	Batteries	Other Film - Other
Tin/Steel Cans - Other	Tires	Durable Plastic Items - Other
Aluminum Cans - CRV		Remainder/Composite Plastic
Aluminum Cans - Non-CRV	Compost/Mulch	Remainder/Composite Organic
PETE Containers - CRV	Other Miscellaneous Paper - Compostable	Other Wood Waste
PETE Containers - Non-CRV	Remainder/Composite Paper - Compostable	Remainder/Composite Inerts and Other
HDPE Containers - CRV	Food	Mercury-Containing Items - Not Lamps
HDPE Containers - Non-CRV	Leaves and Grass	Lamps - Fluorescent and LED
Miscellaneous Plastic Containers - CRV	Prunings and Trimmings	Remainder/Composite Household Hazardous
Miscellaneous Plastic Containers - Non-CRV	Branches and Stumps	Ash
	Manures	Treated Medical Waste
	Clean Dimensional Lumber	Bulky Items
	Clean Engineered Wood	Remainder/Composite Special Waste
	Clean Pallets & Crates	Mixed Residue

Definitions of Material Types (Expanded List)

Paper

1. **Uncoated Corrugated Cardboard** means a paper laminate usually composed of three layers. The center wavy layer is sandwiched between the two outer layers. It does not have any wax coating on the inside or outside. Examples include entire cardboard containers, such as shipping and moving boxes, computer packaging cartons, and sheets and pieces of boxes and cartons. This type does not include chipboard boxes such as cereal and tissue boxes. This type does include very clean (no food residue and only lightly stained) pizza boxes.
2. **Paper Bags** means bags and sheets made from kraft paper. The paper may be brown (unbleached) or white (bleached). Examples include paper grocery bags, clean fast food bags, department store bags, and heavyweight sheets of kraft packing paper.
3. **Newspaper** means paper used in newspapers. Examples include newspaper and glossy inserts found in newspapers, and all items made from newsprint, such as free advertising guides, election guides, plain news packing paper, stapled college class schedules, and tax instruction booklets.
4. **White Ledger Paper** means bleached, uncolored bond, rag, or stationery grade paper, without ground wood fibers. It may have colored ink on it. When the paper is torn, the fibers are white. Examples include white paper used in photocopiers and laser printers, and letter paper.
5. **Other Office Paper** means paper used in offices other than white ledger paper. Examples include colored ledger, computer paper, manila folders, manila envelopes, index cards, white envelopes, white window envelopes, white or colored notebook paper, ground wood computer paper, junk mail, and carbonless forms.
6. **Magazines and Catalogs** means items made of glossy coated paper. This paper is usually slick, smooth to the touch, and reflects light. Examples include glossy magazines, catalogs, brochures, pamphlets, and glossy advertisements.
7. **Phone Books and Directories** means thin paper between coated covers. These items are bound along the spine with glue. Examples include whole or damaged telephone books, yellow pages, real estate listings, and some non-glossy mail order catalogs.
8. **Other Miscellaneous Paper - Compostable** means items made mostly of paper that could be composted, that do not fit into any of the other paper types. Paper may be combined with minor amounts of other materials such as wax or glues. Examples include pulp paper egg cartons, unused pulp paper

plant pots, molded paper packing materials, some berry trays, some take-out food containers, and dirty molded paper plates.

9. **Other Miscellaneous Paper - Other** means items made mostly of paper that do not fit into any of the other paper types, but that are generally recyclable or not generally composted. Paper may be combined with minor amounts of other materials such as wax or glues. This type includes items made of chipboard, ground wood paper, and deep-toned or fluorescent dyed paper. Examples include cereal and cracker boxes, paperboard boxes for software, unused paper plates and cups, goldenrod-colored paper, school construction paper, butcher paper, ice cream cartons and other frozen food boxes, self-adhesive notes, and hardcover and paperback books.
10. **Remainder/Composite Paper - Rigid Food and Beverage Cartons** means aseptic containers (multi-layered packaging that contains shelf-stable food products such as apple juice, soup, soy/rice milk, etc.) and “gable top” cartons (nonrefrigerated items such as granola and crackers; refrigerated items such as milk, juice, egg substitutes, etc.). Rigid food and beverage cartons are usually paper-based, may be any shape, and may include a plastic pour spout as part of the carton.
11. **Remainder/Composite Paper - Compostable** means items made mostly of paper that don’t fit into any other material types, that are combined or contaminated with large amounts of other materials such as wax, food, and moisture, that are compostable. Examples include waxed corrugated cardboard, waxed paper, napkins, tissue, paper towels, fast food wrappers, food-soiled paper and moisture-soiled paper, all pizza boxes (unless at least 95 percent clean), and shredded paper.
12. **Remainder/Composite Paper - Other** means items made mostly of paper but combined with large amounts of other materials. These are items that do not fit into any other categories, are not generally compostable or recyclable, and are not food and beverage cartons. Examples include blueprints, sepia, onion skin, carbon paper, photographs, paper frozen juice cans, sheets of paper stick-on labels, and paper mailing envelopes lined with bubble wrap or plastic.

Glass

13. **Clear Glass Bottles and Containers - CRV** means clear glass containers that display the CRV notification. Examples include whole or broken clear soda bottles and fruit juice bottles, and whole or broken clear wine cooler bottles.
14. **Clear Glass Bottles and Containers - Non-CRV** means clear glass containers that do not display the CRV notification. Examples include clear wine bottles, mayonnaise jars, and jam jars.

15. **Green Glass Bottles and Containers - CRV** means green-colored glass containers that display the CRV notification. Examples include whole or broken green soda and beer bottles.
16. **Green Glass Bottles and Containers - Non-CRV** means green-colored glass containers that do not display the CRV notification. Examples include green wine bottles.
17. **Brown Glass Bottles and Containers - CRV** means brown-colored glass containers that display the CRV notification. Examples include whole or broken brown beer bottles.
18. **Brown Glass Bottles and Containers - Non-CRV** means brown-colored glass containers that do not display the CRV notification. Examples include whole or broken brown wine bottles.
19. **Other Colored Glass Bottles and Containers - CRV** means other-colored glass containers that display the CRV notification. Examples include whole or broken blue soda and water bottles.
20. **Other Colored Glass Bottles and Containers - Non-CRV** means other-colored glass containers that do not display the CRV notification. Examples include whole or broken blue or other colored wine or liquor bottles and other containers.
21. **Flat Glass** means clear or tinted glass that is flat. Examples include glass window panes, doors and table tops, flat automotive window glass (side windows), safety glass, and architectural glass. This type does not include automotive windshields, laminated glass, or any curved glass.
22. **Remainder/Composite Glass** means glass that cannot be put in any other type. It includes items made mostly of glass but combined with other materials. Examples include Pyrex, Corningware, crystal and other glass tableware, mirrors, non-fluorescent light bulbs, auto windshields, laminated glass, or any curved glass.

Metal

23. **Tin/Steel Cans - CRV Bimetal Containers** means rigid containers that have steel sides and aluminum ends and that display the CRV notification. These cans are often used to store beverages.
24. **Tin/Steel Cans - Other** means rigid containers made mainly of steel that are not CRV bimetal cans. These items will stick to a magnet and may be tin-coated. This subtype is used to store food, beverages, paint, and a variety of other household and consumer products. Examples include canned food and beverage containers, empty metal paint cans, empty spray paint and other aerosol containers, and non-CRV bimetal containers with steel sides and aluminum ends.

25. **Major Appliances** means discarded major appliances of any color. These items are often enamel-coated. Examples include washing machines, clothes dryers, hot water heaters, stoves, and refrigerators. This type does not include electronics, such as televisions and stereos.
26. **Used Oil Filters** means metal oil filters used in motor vehicles and other engines, which contain a residue of used oil.
27. **Other Ferrous** means any iron or steel that is magnetic or any stainless steel item. This type does not include tin/steel cans. Examples include structural steel beams, metal clothes hangers, metal pipes, stainless steel cookware, security bars, and scrap ferrous items.
28. **Aluminum Cans - CRV** means any food or beverage container that is made mainly of aluminum and that displays the CRV notification. Examples include most aluminum soda or beer cans. This subtype does not include bimetal containers with steel sides and aluminum ends.
29. **Aluminum Cans - Non-CRV** means any food or beverage container that is made mainly of aluminum and that does not display the CRV notification. Examples include some pet food and meat cans.
30. **Other Non-Ferrous** means any metal item, other than aluminum cans, that is not stainless steel and that is not magnetic. These items may be made of aluminum, copper, brass, bronze, lead, zinc, or other metals. Examples include aluminum window frames, aluminum siding, copper wire, shell casings, brass pipe, and aluminum foil.
31. **Remainder/Composite Metal** means metal that cannot be put in any other type. This type includes items made mostly of metal but combined with other materials and items made of both ferrous metal and non-ferrous metal combined. Examples include small non-electronic appliances such as toasters and hair dryers, motors, insulated wire, and finished products that contain a mixture of metals, or metals and other materials, whose weight is derived significantly from the metal portion of its construction.

Electronics

32. **Brown Goods** means generally larger, non-portable electronic goods that have some circuitry. Examples include microwaves, stereos, VCRs, DVD players, large radios, and audio/visual equipment. Does not include items with video display devices.
33. **Computer-Related Electronics** means electronics with large circuitry that is computer-related, not including monitors. Examples include processors, keyboards, printers, fax machines, mice, disk drives, and modems.
34. **Other Small Consumer Electronics** means portable non-computer-related electronics with large circuitry. Examples include personal digital assistants (PDAs), cell phones (including those with a screen larger than 4 inches),

phone systems, phone answering machines, portable electronic book readers (like Kindles and Nooks) and other devices for reading static text, computer games and other electronic toys, portable CD players, camcorders, digital cameras, cell phone chargers and other electronic device chargers, and other electronic devices.

35. **Video Display Devices - CRT** means items with video displays larger than 4 inches that contain a cathode ray tube (CRT). Examples include some televisions, computer monitors, and other items containing a CRT. The shape of the item is usually more boxy than flat.
36. **Video Display Devices - Other** means items with video displays larger than 4 inches that are not CRTs, nor are they included in the Other Small Consumer Electronics category. Examples include some televisions, computer monitors, portable DVD players, tablet computers (like the iPad and Kindle Fire), and laptop computers. The shape of the item is usually more flat than boxy, and the device is primarily intended to display moving video, perform computing functions, or view web content.

Plastic

37. **PETE Containers - CRV** means clear or colored PET containers that display the CRV notification. When marked for identification, it bears the number “1” in the center of the triangular recycling symbol and may also bear the letters “PETE” or “PET.” The color is usually transparent green or clear. A PET container usually has a small dot left from the manufacturing process, not a seam. It does not turn white when bent. Examples include soda and water bottles.
38. **PETE Containers - Non-CRV** means clear or colored PET containers that do not display the CRV notification. When marked for identification, it bears the number “1” in the center of the triangular recycling symbol and may also bear the letters “PETE” or “PET.” The color is usually transparent green or clear. A PET container usually has a small dot left from the manufacturing process, not a seam. It does not turn white when bent. Examples include non-CRV juice or water bottles, some liquor bottles, cooking oil containers, food jars, pastry jars, frozen food or other trays, clamshell packaging, and aspirin bottles.
39. **HDPE Containers - CRV** means natural and colored HDPE containers that display the CRV notification. This plastic is usually either cloudy white, allowing light to pass through it (natural) or a solid color, preventing light from passing through it (colored). When marked for identification, it bears the number “2” in the triangular recycling symbol and may also bear the letters “HDPE.” Examples include some small juice bottles.
40. **HDPE Containers - Non-CRV** means natural and colored HDPE containers that do not display the CRV notification. This plastic is usually either cloudy

- white, allowing light to pass through it (natural) or a solid color, preventing light from passing through it (colored). When marked for identification, it bears the number “2” in the triangular recycling symbol and may also bear the letters “HDPE.” Examples include milk jugs, detergent bottles, some hair-care bottles, some margarine and yogurt tubs, clamshell packaging, empty motor oil, empty antifreeze, and other empty vehicle and equipment fluid containers.
41. **Miscellaneous Plastic Containers - CRV** means plastic containers that display the CRV notification that are made of types of plastic other than HDPE or PET. Items may be made of PVC, PP, or PS or mixed resins. When marked for identification, these items may bear the number “3,” “4,” “5,” “6,” or “7” in the triangular recycling symbol. This subtype also includes plastic containers that do not have the triangular recycling symbol.
 42. **Miscellaneous Plastic Containers - Non-CRV** means plastic containers that do not display the CRV notification that are made of types of plastic other than HDPE or PET. Items may be made of PVC, PP, or PS. When marked for identification, these items may bear the number “3,” “4,” “5,” “6,” or “7” in the triangular recycling symbol. This subtype also includes plastic containers that do not have the triangular recycling symbol. Examples include hardware and fastener packaging, food containers such as bottles for salad dressings and vegetable oils, flexible and brittle yogurt cups, syrup bottles, margarine tubs, microwave food trays, and clamshell-shaped fast food containers. This type also includes some shampoo containers, vitamin bottles, foam egg cartons, and clamshell-like muffin containers.
 43. **Plastic Trash Bags** means plastic bags sold for use as trash bags, for both residential and commercial use. This type includes garbage, kitchen, compactor, can-liner, composting, yard, lawn, leaf, and recycling bags. This type does not include other plastic bags, like shopping bags, that might have been used to contain trash.
 44. **Plastic Grocery and Other Merchandise Bags** means plastic shopping bags used to contain merchandise to transport from the place of purchase, given out by the store with the purchase. This type includes dry cleaning bags intended for one-time use. Does not include produce bags.
 45. **Non-Bag Commercial and Industrial Packaging Film** means film plastic used for large-scale packaging or transport packaging. Examples include shrink-wrap, mattress bags, furniture wrap, and film bubble wrap.
 46. **Film Products** means plastic film used for purposes other than packaging. Examples include agricultural film (films used in various farming and growing applications, such as silage greenhouse films, mulch films, and wrap for hay bales), plastic sheeting used as drop cloths, and building wrap.
 47. **Other Film - Flexible Plastic Pouches** means plastic pouches made of thicker, multi-layer flexible material. May have a flat bottom so that package

would stand up on its own, but not always. Material is thicker than potato chip bags and frozen vegetable bags. Includes plastic coffee bags like Starbucks and Peet's; Capri Sun pouches; baby food pouches – may have plastic screw top; soup pouches; salad dressing pouches; wine pouches; backpacking meals in pouches; soap refill pouches; laundry detergent pouches; and other similar items.

INCLUDED – THICKER, MULTI-LAYER PACKAGING	EXCLUDED – THINNER, SINGLE-LAYER PACKAGING
Plastic coffee bags (Starbucks and Peet's) Juice pouches (Capri Sun) Baby food pouches – may have plastic screw top Soup pouches Salad dressing pouches Wine pouches Backpacking meals in pouches Soap refill pouches Laundry detergent pouches Other similar items	Potato chip bags and similar Candy wrappers Tortilla bags Frozen food bags (vegetables, berries) Nut/snack bags Shrink plastic wrappers (Slim Jim and string cheese wrappers) Ziplock bags intended for home use Thin produce bags as used in grocery stores Newspaper bags Bread bags Small (2 inch) pouches for condiments (mustard, relish, etc.) Yogurt tubes (Gogurt) Mailing pouches, usually colored or white (not clear) (LL Bean, medication pouches) 100% Plastic mailing pouches with bubble wrap Other similar items

48. **Other Film – Other** means all other plastic film that does not fit into any other type, excluding flexible plastic pouches. Examples include other types of plastic bags (sandwich bags, zipper-recloseable bags, newspaper bags, produce bags, frozen vegetable bags, bread bags), food wrappers such as candy-bar wrappers, potato chip bags, mailing pouches, bank bags, X-ray film, metallized film (such as balloons), and plastic food wrap.
49. **Durable Plastic Items - #2 and #5 Bulky Rigids** means plastic items, other than containers or film plastic, that are large (generally larger than a soccer ball) rigid #2 HDPE or #5 PP plastic bulky items. These items are made to last for more than one use. These items usually bear the number 2 or 5 in the triangular recycling symbol. Examples include: crates, buckets (including 5-gallon buckets), baskets, totes, large plastic garbage cans, large tubs, large storage tubs/bins (usually with lids) that don't have sharp corners, flexible

(non-brittle) flower pots of 1 gallon size or larger, lawn furniture, large plastic toys, tool boxes, first aid boxes, and some sporting goods.

50. **Durable Plastic Items - Other** means plastic items other than containers or film plastic, that are often made to last for more than one use that are not large rigid items made from #2 or #5 plastics. These items may bear the numbers 1 through 7 in the triangular recycling symbol. Examples include CDs and their cases, plastic housewares such as dishes, cups, and cutlery. This type also includes building materials such as house siding, window sashes and frames, housings for electronics such as computers, televisions and stereos, fan blades, and plastic pipes and fittings.
51. **Remainder/Composite Plastic** means plastic that cannot be put in any other type. These items are usually recognized by their optical opacity. This type includes items made mostly of plastic but combined with other materials. Examples include auto parts made of plastic attached to metal, plastic drinking straws, foam drinking cups, plastic cups, produce trays, foam meat and pastry trays, foam packing blocks, packing peanuts, cookie trays found in cookie packages, plastic strapping, plastic lids, some kitchen ware, some toys, foam plates/bowls, window blinds, plastic lumber, insulating foam, imitation ceramics, handles and knobs, plastic string (such as used for hay bales), plastic rigid bubble/foil packaging (as for medications), small (less than 1 gallon) plant containers such as nursery pots and plant six-packs, and new Formica, new vinyl, or new linoleum.

Other Organics

52. **Food** means food material resulting from the processing, storage, preparation, cooking, handling, or consumption of food. This type includes material from industrial, commercial, or residential sources. Examples include discarded meat scraps, dairy products, eggshells, fruit or vegetable peels, and other food items from homes, stores, and restaurants. This type includes grape pomace and other processed residues or material from canneries, wineries, or other industrial sources.
53. **Leaves and Grass** means plant material, except woody material, from any public or private landscape. Examples include leaves, grass clippings, plants, and seaweed. This type does not include woody material or material from agricultural sources.
54. **Prunings and Trimmings** means woody plant material up to 4 inches in diameter from any public or private landscape. Examples include prunings, shrubs, and small branches with branch diameters that do not exceed 4 inches. This type does not include stumps, tree trunks, branches exceeding 4 inches in diameter, or material from agricultural sources.
55. **Branches and Stumps** means woody plant material, branches, and stumps that exceed 4 inches in diameter, from any public or private landscape.

56. **Manures** means manure and soiled bedding materials from large domestic, farm, or ranch animals. Examples include manure and soiled bedding from animal production operations, racetracks, riding stables, animal hospitals, and other sources. Does not include feces from small household pets such as dogs and cats.
57. **Textiles** means items made of thread, yarn, fabric, or cloth. Examples include clothes, fabric trimmings, draperies, and all natural and synthetic cloth fibers. This type does not include cloth-covered furniture, mattresses, leather shoes, leather bags, or leather belts.
58. **Carpet** means flooring applications consisting of various natural or synthetic fibers bonded to some type of backing material. This type does not include carpet padding or woven rugs with no backing.
59. **Remainder/Composite Organic** means organic material that cannot be put in any other type. This type includes items made mostly of organic materials, but combined with other material types. Examples include leather items, cork, hemp rope, garden hoses, rubber items, hair, carpet padding, cigarette butts, diapers, feminine hygiene products, small wood products (such as Popsicle sticks and toothpicks), sawdust, agricultural crop residues, and animal feces from small household pets such as dogs and cats.

Inerts and Other

60. **Concrete** means a hard material made from sand, aggregate, gravel, cement mix, and water. Examples include pieces of building foundations, concrete paving, and concrete/cinder blocks. This category includes concrete with a steel internal structure composed of reinforcing bars (re-bar) or metal mesh.
61. **Asphalt Paving** means a black or brown, tar-like material mixed with aggregate used as a paving material.
62. **Asphalt Roofing** means composite shingles and other roofing material made with asphalt. Examples include asphalt shingles and attached roofing tar and tar paper.
63. **Clean Dimensional Lumber** means unpainted new or demolition dimensional lumber. Includes materials such as 2 x 4s, 2 x 6s, 2 x 12s, and other residual materials from framing and related construction activities. May contain nails or other trace contaminants.
64. **Clean Engineered Wood** means unpainted new or demolition scrap from sheathed goods such as plywood, particleboard, wafer board, oriented strand board, and other residual materials used for sheathing and related construction uses. May contain nails or other trace contaminants.
65. **Clean Pallets and Crates** means unpainted wood pallets, crates, and packaging made of lumber/engineered wood.

66. **Other Wood Waste** means wood waste that cannot be put into any other material type. This type may include untreated/unpainted scrap from production of prefabricated wood products such as wood furniture or cabinets, untreated or unpainted wood roofing and siding, painted or stained wood, and treated wood.
67. **Gypsum Board** means interior wall covering made of a sheet of gypsum sandwiched between paper layers. Examples include used or unused broken or whole sheets. Gypsum board may also be called sheetrock, drywall, plasterboard, gypboard, gyproc, or wallboard. Includes painted gypsum board.
68. **Rock, Soil and Fines** means rock pieces of any size and soil, dirt, and other matter. Examples include rock, stones, sand, clay, soil and other fines. This type also includes nonhazardous contaminated soil.
69. **Remainder/Composite Inerts and Other** means inerts and other material that cannot be put in any other type. This type may include items from different types combined, which would be very hard to separate. Examples include brick, ceramics, tiles, toilets, sinks, dried paint not attached to other materials, and fiberglass insulation. This type may also include demolition debris that is a mixture of items such as plate glass, wood, tiles, gypsum board, synthetic counter tops, fiber or composite acoustic ceiling tiles, and aluminum scrap.

Household Hazardous Waste (HHW)

70. **Paint** means containers with paint in them. Examples include latex paint, oil-based paint, and tubes of pigment or fine art paint. This type does not include dried paint, empty paint cans, or empty aerosol containers.
71. **Vehicle and Equipment Fluids** means containers with fluids used in vehicles or engines, except used oil. Examples include used antifreeze and brake fluid. This type does not include empty vehicle and equipment fluid containers.
72. **Used Oil** means the same as defined in Health and Safety Code section 25250.1(a). Examples include spent lubricating oil such as crankcase and transmission oil, gear oil, and hydraulic oil.
73. **Batteries** means any type of battery including both dry cell, rechargeable, and lead acid. Examples include car, flashlight, small appliance, watch, and hearing aid batteries.
74. **Mercury-Containing Items - Not Lamps** means items other than lamps that are readily identifiable as containing mercury such as thermostats and thermometers.
75. **Lamps - Fluorescent and LED** means both compact and tube-style fluorescent lights, and LED lights.

76. **Remainder/Composite Household Hazardous** means household hazardous material that cannot be put in any other type. This type also includes household hazardous material that is mixed. Examples include household hazardous waste that, if improperly put in the solid waste stream, may present handling problems or other hazards, such as pesticides and caustic cleaners; sharps (needles), medications, and supplements.

Special Waste

77. **Ash** means a residue from the combustion of any solid or liquid material. Examples include ash from fireplaces, incinerators, biomass facilities, waste-to-energy facilities, and barbecues. This type also includes ash and burned debris from structure fires.
78. **Treated Medical Waste** means medical waste that has been processed in order to change its physical, chemical, or biological character or composition, or to remove or reduce its harmful properties or characteristics, as defined in Section 25123.5 of the Health and Safety Code.
79. **Bulky Items** means large, hard-to-handle items that are not defined elsewhere in the material types list, including furniture, mattresses, and other large items. Examples include all sizes and types of furniture, box springs, and base components.
80. **Tires** means vehicle tires. Tires may be pneumatic or solid. Examples include tires from trucks, automobiles, motorcycles, heavy equipment, lawn mowers, and bicycles.
81. **Remainder/Composite Special Waste** means special waste that cannot be put in any other type. Examples include asbestos-containing materials such as certain types of pipe insulation and floor tiles, auto fluff, auto bodies, trucks, trailers, truck cabs, untreated medical waste (such as tubes, oxygen masks, and medical instruments), and artificial fireplace logs.

Mixed Residue

82. **Mixed Residue** means material that cannot be put in any other type or category. This category includes mixed residue that cannot be further sorted. Examples include clumping kitty litter, cosmetics, partially filled containers of non-food consumer products, and residual material from a material recovery facility or other sorting process that cannot be put in any other material type, including remainder/composite types.

Material Type Examples
Other Film - Flexible Plastic Pouches



Remainder/Composite Paper - Rigid Food and Beverage Cartons



Appendix C: Forms Used in the Study

List of Forms Used

Examples of the field forms used in the study appear in this appendix in the following order:

- Vehicle Selection Form
- Sample Placard
- Sample Sorting & Characterization Form
- Vehicle Survey Form
- Multi-Family Site Recruitment Database
- Multi-Family Site Visit Form
- Solid Waste Facility Recruitment Script
- Solid Waste Facility Recruitment Form
- Waste Composition Data Entry Database
- Vehicle Survey Data Entry Spreadsheet

Vehicle Selection Form

California Statewide Waste Characterization Study Vehicle Selection Form																																																																																																																									
Date: _____	Samples Needed: <u>15</u>																																																																																																																								
Site: _____																																																																																																																									
Region: _____																																																																																																																									
<p>Each Number represents an expected vehicle based on the available data. Cross off one number for each category of vehicle entering the landfill. When you reach the number circled, ask this vehicle to go to the sorting area.</p> <p style="text-align: center;"> Sample from Vehicle Survey Vehicle </p>																																																																																																																									
Commercial	Samples Needed: 5																																																																																																																								
* Must be at least 80% commercial Waste																																																																																																																									
<table style="width: 100%; border-collapse: collapse;"> <tr><td>1</td><td>2</td><td>3</td><td>4</td><td>5</td><td>6</td><td style="border: 1px solid black;">7</td><td>8</td><td>9</td><td>10</td><td>11</td><td>12</td><td>13</td><td style="border: 1px solid black;">14</td><td>15</td></tr> <tr><td>16</td><td>17</td><td>18</td><td>19</td><td>20</td><td style="border: 1px solid black;">21</td><td>22</td><td>23</td><td>24</td><td>25</td><td>26</td><td>27</td><td style="border: 1px solid black;">28</td><td>29</td><td>30</td></tr> <tr><td>31</td><td>32</td><td>33</td><td>34</td><td style="border: 1px solid black;">35</td><td>36</td><td>37</td><td>38</td><td>39</td><td>40</td><td>41</td><td>42</td><td>43</td><td>44</td><td>45</td></tr> <tr><td>46</td><td>47</td><td>48</td><td>49</td><td>50</td><td>51</td><td>52</td><td>53</td><td>54</td><td>55</td><td>56</td><td>57</td><td>58</td><td>59</td><td>60</td></tr> <tr><td>61</td><td>62</td><td>63</td><td>64</td><td>65</td><td>66</td><td>67</td><td>68</td><td>69</td><td>70</td><td>71</td><td>72</td><td>73</td><td>74</td><td>75</td></tr> <tr><td>76</td><td>77</td><td>78</td><td>79</td><td>80</td><td>81</td><td>82</td><td>83</td><td>84</td><td>85</td><td>86</td><td>87</td><td>88</td><td>89</td><td>90</td></tr> <tr><td>91</td><td>92</td><td>93</td><td>94</td><td>95</td><td>96</td><td>97</td><td>98</td><td>99</td><td>100</td><td>101</td><td>102</td><td>103</td><td>104</td><td>105</td></tr> <tr><td>106</td><td>107</td><td>108</td><td>109</td><td>110</td><td>111</td><td>112</td><td>113</td><td>114</td><td>115</td><td>116</td><td>117</td><td>118</td><td>119</td><td>120</td></tr> </table> <p style="text-align: center;">(expect 70)</p>	1	2	3	4	5	6	7	8	9	10	11	12	13	14	15	16	17	18	19	20	21	22	23	24	25	26	27	28	29	30	31	32	33	34	35	36	37	38	39	40	41	42	43	44	45	46	47	48	49	50	51	52	53	54	55	56	57	58	59	60	61	62	63	64	65	66	67	68	69	70	71	72	73	74	75	76	77	78	79	80	81	82	83	84	85	86	87	88	89	90	91	92	93	94	95	96	97	98	99	100	101	102	103	104	105	106	107	108	109	110	111	112	113	114	115	116	117	118	119	120	<p style="text-align: center;">Samples Taken</p> <div style="border: 1px solid black; width: 100%; height: 100%;"></div>
1	2	3	4	5	6	7	8	9	10	11	12	13	14	15																																																																																																											
16	17	18	19	20	21	22	23	24	25	26	27	28	29	30																																																																																																											
31	32	33	34	35	36	37	38	39	40	41	42	43	44	45																																																																																																											
46	47	48	49	50	51	52	53	54	55	56	57	58	59	60																																																																																																											
61	62	63	64	65	66	67	68	69	70	71	72	73	74	75																																																																																																											
76	77	78	79	80	81	82	83	84	85	86	87	88	89	90																																																																																																											
91	92	93	94	95	96	97	98	99	100	101	102	103	104	105																																																																																																											
106	107	108	109	110	111	112	113	114	115	116	117	118	119	120																																																																																																											
Residential	Samples Needed: 4																																																																																																																								
* Must be at least 80% Residential Waste																																																																																																																									
<table style="width: 100%; border-collapse: collapse;"> <tr><td>1</td><td>2</td><td>3</td><td>4</td><td>5</td><td>6</td><td>7</td><td style="border: 1px solid black;">8</td><td>9</td><td>10</td><td>11</td><td>12</td><td>13</td><td>14</td><td>15</td></tr> <tr><td style="border: 1px solid black;">16</td><td>17</td><td>18</td><td>19</td><td>20</td><td>21</td><td>22</td><td>23</td><td style="border: 1px solid black;">24</td><td>25</td><td>26</td><td>27</td><td>28</td><td>29</td><td>30</td></tr> <tr><td>31</td><td style="border: 1px solid black;">32</td><td>33</td><td>34</td><td>35</td><td>36</td><td>37</td><td>38</td><td>39</td><td>40</td><td>41</td><td>42</td><td>43</td><td>44</td><td>45</td></tr> <tr><td>46</td><td>47</td><td>48</td><td>49</td><td>50</td><td>51</td><td>52</td><td>53</td><td>54</td><td>55</td><td>56</td><td>57</td><td>58</td><td>59</td><td>60</td></tr> <tr><td>61</td><td>62</td><td>63</td><td>64</td><td>65</td><td>66</td><td>67</td><td>68</td><td>69</td><td>70</td><td>71</td><td>72</td><td>73</td><td>74</td><td>75</td></tr> <tr><td>76</td><td>77</td><td>78</td><td>79</td><td>80</td><td>81</td><td>82</td><td>83</td><td>84</td><td>85</td><td>86</td><td>87</td><td>88</td><td>89</td><td>90</td></tr> <tr><td>91</td><td>92</td><td>93</td><td>94</td><td>95</td><td>96</td><td>97</td><td>98</td><td>99</td><td>100</td><td>101</td><td>102</td><td>103</td><td>104</td><td>105</td></tr> <tr><td>106</td><td>107</td><td>108</td><td>109</td><td>110</td><td>111</td><td>112</td><td>113</td><td>114</td><td>115</td><td>116</td><td>117</td><td>118</td><td>119</td><td>120</td></tr> </table> <p style="text-align: center;">(expect 66)</p>	1	2	3	4	5	6	7	8	9	10	11	12	13	14	15	16	17	18	19	20	21	22	23	24	25	26	27	28	29	30	31	32	33	34	35	36	37	38	39	40	41	42	43	44	45	46	47	48	49	50	51	52	53	54	55	56	57	58	59	60	61	62	63	64	65	66	67	68	69	70	71	72	73	74	75	76	77	78	79	80	81	82	83	84	85	86	87	88	89	90	91	92	93	94	95	96	97	98	99	100	101	102	103	104	105	106	107	108	109	110	111	112	113	114	115	116	117	118	119	120	<p style="text-align: center;">Samples Taken</p> <div style="border: 1px solid black; width: 100%; height: 100%;"></div>
1	2	3	4	5	6	7	8	9	10	11	12	13	14	15																																																																																																											
16	17	18	19	20	21	22	23	24	25	26	27	28	29	30																																																																																																											
31	32	33	34	35	36	37	38	39	40	41	42	43	44	45																																																																																																											
46	47	48	49	50	51	52	53	54	55	56	57	58	59	60																																																																																																											
61	62	63	64	65	66	67	68	69	70	71	72	73	74	75																																																																																																											
76	77	78	79	80	81	82	83	84	85	86	87	88	89	90																																																																																																											
91	92	93	94	95	96	97	98	99	100	101	102	103	104	105																																																																																																											
106	107	108	109	110	111	112	113	114	115	116	117	118	119	120																																																																																																											
Self-Haul	Samples Needed: 5																																																																																																																								
<table style="width: 100%; border-collapse: collapse;"> <tr><td>1</td><td>2</td><td>3</td><td>4</td><td>5</td><td>6</td><td>7</td><td>8</td><td style="border: 1px solid black;">9</td><td>10</td><td>11</td><td>12</td><td>13</td><td>14</td><td>15</td></tr> <tr><td>16</td><td>17</td><td style="border: 1px solid black;">18</td><td>19</td><td>20</td><td>21</td><td>22</td><td>23</td><td>24</td><td>25</td><td>26</td><td style="border: 1px solid black;">27</td><td>28</td><td>29</td><td>30</td></tr> <tr><td>31</td><td>32</td><td>33</td><td>34</td><td>35</td><td style="border: 1px solid black;">36</td><td>37</td><td>38</td><td>39</td><td>40</td><td>41</td><td>42</td><td>43</td><td>44</td><td style="border: 1px solid black;">45</td></tr> <tr><td>46</td><td>47</td><td>48</td><td>49</td><td>50</td><td>51</td><td>52</td><td>53</td><td>54</td><td>55</td><td>56</td><td>57</td><td>58</td><td>59</td><td>60</td></tr> <tr><td>61</td><td>62</td><td>63</td><td>64</td><td>65</td><td>66</td><td>67</td><td>68</td><td>69</td><td>70</td><td>71</td><td>72</td><td>73</td><td>74</td><td>75</td></tr> <tr><td>76</td><td>77</td><td>78</td><td>79</td><td>80</td><td>81</td><td>82</td><td>83</td><td>84</td><td>85</td><td>86</td><td>87</td><td>88</td><td>89</td><td>90</td></tr> <tr><td>91</td><td>92</td><td>93</td><td>94</td><td>95</td><td>96</td><td>97</td><td>98</td><td>99</td><td>100</td><td>101</td><td>102</td><td>103</td><td>104</td><td>105</td></tr> <tr><td>106</td><td>107</td><td>108</td><td>109</td><td>110</td><td>111</td><td>112</td><td>113</td><td>114</td><td>115</td><td>116</td><td>117</td><td>118</td><td>119</td><td>120</td></tr> </table> <p style="text-align: center;">(expect 140)</p>	1	2	3	4	5	6	7	8	9	10	11	12	13	14	15	16	17	18	19	20	21	22	23	24	25	26	27	28	29	30	31	32	33	34	35	36	37	38	39	40	41	42	43	44	45	46	47	48	49	50	51	52	53	54	55	56	57	58	59	60	61	62	63	64	65	66	67	68	69	70	71	72	73	74	75	76	77	78	79	80	81	82	83	84	85	86	87	88	89	90	91	92	93	94	95	96	97	98	99	100	101	102	103	104	105	106	107	108	109	110	111	112	113	114	115	116	117	118	119	120	<p style="text-align: center;">Samples Taken</p> <div style="border: 1px solid black; width: 100%; height: 100%;"></div>
1	2	3	4	5	6	7	8	9	10	11	12	13	14	15																																																																																																											
16	17	18	19	20	21	22	23	24	25	26	27	28	29	30																																																																																																											
31	32	33	34	35	36	37	38	39	40	41	42	43	44	45																																																																																																											
46	47	48	49	50	51	52	53	54	55	56	57	58	59	60																																																																																																											
61	62	63	64	65	66	67	68	69	70	71	72	73	74	75																																																																																																											
76	77	78	79	80	81	82	83	84	85	86	87	88	89	90																																																																																																											
91	92	93	94	95	96	97	98	99	100	101	102	103	104	105																																																																																																											
106	107	108	109	110	111	112	113	114	115	116	117	118	119	120																																																																																																											
Multi-Family Generator Sample	Samples Needed: 1																																																																																																																								
<table style="width: 100%; border-collapse: collapse;"> <tr><td style="border: 1px solid black; width: 20px; height: 20px; text-align: center;">1</td></tr> </table>	1																																																																																																																								
1																																																																																																																									

Sample Placard

CALSIERRA TS

COM - 1

1/17/2014

- Front Load
- Rear Load
- RO - Compactor
- RO - Open Top
- RO - Closed Top

Sample Sorting & Characterization Form (front)

California 2014 Statewide Waste Characterization Field Data Sheet

Sample ID: _____ Crew Chief: _____
 Location: _____ Date: _____ Cell #: _____
 Generator Type: _____ Container Type: _____

#	Material	Gross Weight	# of Weights
1	Uncoated Corrugated Cardboard		
2	Paper Bags		
3	Newspaper		
4	White Computer/Copy/Notebook Paper		
5	Other Office Paper		
6	Magazines and Catalogs		
7	Phone Books and Directories		
8	Molded Pulp Paper		
9	Other Mixed Paper		
10	Food and Beverage Cartons		
11	Compostable Paper		
12	Remainder/Composite Paper		
13	PETE Containers - CRV		
14	PETE Containers - Non-CRV		
15	HDPE Containers - CRV		
16	HDPE Containers - Non-CRV		
17	Miscellaneous Plastic Containers - CRV		
18	Misc. Plastic Containers - Non-CRV		
19	Plastic Trash Bags		
20	Merchandise Bags		
21	Non-Bag Commercial Packaging Film		
22	Film Products		
23	Flexible Plastic Pouches		
24	Other Film		
25	Durable Plastic - #2 and #5 Bulky Rigids		
26	Durable Plastic Items - Other		
27	Remainder/Composite Plastic		
28	Clear Glass Bottles/Containers - CRV		
29	Clear Glass Bottles/Containers - Non-		
30	Green Glass Bottles/Containers - CRV		
31	Green Glass Bottles/Containers - Non-		
32	Brown Glass Bottles/Containers - CRV		
33	Brown Glass Bottles/Cont. - Non-CRV		
34	Other Colored Glass Bottles/Cont. - CRV		
35	Other Colored Glass Bot./Cont. - Non-		
36	Flat Glass		
37	Remainder/Composite Glass		

Sample Sorting & Characterization Form (back)

California 2014 Statewide Waste Characterization Field Data Sheet

Sample ID: _____

Crew Chief: _____

38	Tin/Steel Cans - CRV Containers		
39	Tin/Steel Cans - Other		
40	Major Appliances		
41	Used Oil Filters		
42	Other Scrap Steel		
43	Aluminum Cans - CRV		
44	Aluminum Cans - Non-CRV		
45	Other Non-Steel		
46	Remainder/Composite Metal		
47	Food		
48	Leaves & Grass (% Leaves)	<input type="text"/>	
49	Prunings and Trimmings		
50	Branches and Stumps		
51	Manures		
52	Textiles		
53	Carpet		
54	Remainder/Composite Organic		
55	Concrete		
56	Asphalt Paving		
57	Asphalt Roofing		
58	Clean Dimensional Lumber		
59	Clean Engineered Wood		
60	Clean Pallets and Crates		
61	Other Wood Waste		
62	Gypsum Board		
63	Rock, Soil and Fines		
64	Remainder/Composite Inerts and Other		
65	Brown Goods		
66	Computer-related Electronics		
67	Other Small Consumer Electronics		
68	Video Display Devices - CRT		
69	Video Display Devices - Other		
70	Paint		
71	Vehicle and Equipment Fluids		
72	Used Oil		
73	Batteries		
74	Mercury-Containing Items - Not Lamps		
75	Fluorescent Light Bulbs		
76	Household Hazardous Waste		
77	Ash		
78	Treated Medical Waste		
79	Bulky Items		
80	Tires		
81	Remainder/Composite Special Waste		
82	Mixed Residue		

Vehicle Survey Form (front)

**California Statewide Waste Characterization Study
Vehicle Survey Form**

Date ___/___/___ Page ___ of ___

Survey Site _____ Surveyor _____

Minimum weight at this site _____ This sheet started at _____ am pm Checked by _____

All Vehicles										Sample Number	% Recycled	Surveyor's Notes
ID	Hauler Type	Vehicle Type	Jurisdiction	Material Hauled	Generator	From Construction Site?	Net Weight of Load					
	C - Commercial Hauler M - Municipal Sanitation CN - Contractor R - Res./Home Owner J - Junk Removal Hauler O - Other private/ Government Entity	1. Packer 2. DB, Loose 3. DB, Cmpctd 4. Pick-up, Van, SUV, Bx Truck 5. Car 6. Semi Truck	Please list the city of origin that the waste came from	R - Refuse C&D - Construction and Demolition L - Landscaping	SF - Single-family Residential MF - Multifamily COM - Commercial MRF - MRF Residue	If no <input type="checkbox"/> No = Not from Const. N=new construction If yes <input type="checkbox"/> R=remodel D=demolition RF=roofing OC=other c&d	Circle units if they aren't all the same. Default units (circle one) tons lbs yds			If needed for net weights, record license/ticket #s here. Enter hauler name if space permits.		
	Choose One	Choose One		Circle only one	Must Equal 100%	Select One Only						
				R C&D L	% SF % MF %COM %MRF	No N R D RF OC	tons lbs yds					
				R C&D L		No N R D RF OC	tons lbs yds					
				R C&D L		No N R D RF OC	tons lbs yds					
				R C&D L		No N R D RF OC	tons lbs yds					
				R C&D L		No N R D RF OC	tons lbs yds					
				R C&D L		No N R D RF OC	tons lbs yds					
				R C&D L		No N R D RF OC	tons lbs yds					
				R C&D L		No N R D RF OC	tons lbs yds					
				R C&D L		No N R D RF OC	tons lbs yds					
				R C&D L		No N R D RF OC	tons lbs yds					
				R C&D L		No N R D RF OC	tons lbs yds					
				R C&D L		No N R D RF OC	tons lbs yds					
				R C&D L		No N R D RF OC	tons lbs yds					
				R C&D L		No N R D RF OC	tons lbs yds					
				R C&D L		No N R D RF OC	tons lbs yds					

Vehicle Survey Form (back)

GENERAL INSTRUCTIONS

- Enter the information at the top of each page. Enter total # of pages on each page at the end of the day.
- Enter the net weight of the load. If the operator measures self-haul loads by volume, record the volume and indicate that the unit is "yds".
- If the load is from a construction site, circle only one of the activities in the From Construction Site? column.
- If load is not from a construction site ask if it's Landscaping.
- If it's a commercial hauler ask if load is MRF residuals.
- If you make an error on an entry, draw a line through the entire entry and start over on a new line.

CHECK IN WITH GATEHOUSE STAFF

Confirm the method for getting net weights.

AS THE VEHICLE ARRIVES RECORD THE TYPE OF VEHICLE ON THE SURVEY SHEET

HAULER TYPE

C - Commercial Hauler	Haulers contracted by a City/County/Municipal gov't to haul from residents, businesses, and institutions. May be hauling MSW, C&D, or bulky waste.
M - Municipal Sanitation	City/County/Municipal gov't that hauls residential, business, and institutional waste. May be hauling MSW, C&D, or bulky waste. For example, the city of San Diego.
CN - Contractor	Private business, agencies, or institutions hauling waste they generate in the course of their operations. This includes garbage, C&D, bulky, or landscaping. Examples are Joe's Roofing and Goodwill hauling their own garbage.
R - Residential/Home Owners	Individuals and home owners hauling their own household trash and clean up. Can be bagged or loose trash, C&D, bulky, or yard waste. May be from multifamily but usually single family
J - Junk Removal	On call haulers of trash and bulky waste from residential or business locations. An example is "1-800 Got Junk."
O - Other Private/Govt. Entity	Other private/governmental hauler. Examples include the parks department, CalTrans, sewage treatment departments, universities, prisons, etc.

VEHICLE TYPE

1. Packer	Packer trucks can be front load, side load, or rear load vehicles
2. DB, Loose	Roll-off loose debris boxes can be closed top or open top. The hauler picks this container up on a rail truck. The container is not a separate trailer.
3 DB, Compacted	Roll-off compacting debris box can be sealed or with small opening in back covered with soft cover. The hauler picks this container up on a rail truck. The container is not a separate trailer.
4. Pick-up, Van, SUV, Bx Truck, Dump beds	Can be a pick-up, pick-up with trailer, SUV (sport utility vehicle), box truck (i.e. U-Haul), or flat bed truck (truck with no sides or stake sides), passenger or cargo van, or vehicles with hydraulic dump beds.
5. Car	Passenger car
6. Semi-Truck	A 2 or 3 axle tractor pulling a 1 to 3 axle trailer. The trailer can be open or closed top. The trailer can be separated from the tractor.

MATERIAL TYPE

R - Refuse	Garbage from single-family, multi-family, or businesses.
C&D - Construction and Demolition	Waste generated by the activities of construction or demolition
L - Landscaping	Material such as green waste, rock, soil, or other activities generated by landscapers.

GENERATOR TYPE

SF - Single-family Residential	Household garbage, yard waste, or C&D generated at single-family parcels
MF - Multifamily Residential	Household garbage, yard waste, or C&D generated at multifamily parcels
COM - Commercial	Waste generated at industrial, commercial, or institutional parcels
MRF - MRF Residue	Residue generated by sorting recyclables at a Material Recovery Facility

FROM A CONSTRUCTION SITE

No = Not from Const. Site	Circle "No" if the load is not from a Construction and Demolition site.
N=new construction	Circle "N" if the load is from a new construction site.
R=remodel	Circle "R" if load has been generated by renovation activities
D=demolition	Circle "D" if the load has been generated by demolitions activities
RF=roofing	Circle "RF" if load has been generated by roofing activities.
OC=other c&d	Circle "OC" if load has been generated by any other const. or demolition activity

Snapshot of Multi-Family Site Recruitment Database (Page 1)

frmRecruit - Microsoft Access

Home Create External Data Database Tools Acrobat

Bus ID **1000000** Company Name **Dummy Apartments** Need reminder call Call back to verify or get more info

COS got to yes
 CCG to Yes
 Recruitment Data Entered

All Sampling Issues Resolved
 All Data Issues Resolved
 Discard

CCG Recruiter: Patrick
 Date of COS Call:
 Date of CCG Call: 1/10/2014
 Requested Copy of Results
 OK for CalRec. to Contact

Eligible for Sampling in Season
 Winter Spring Summer Fall
 Sampled in Season
 Winter Spring Summer Fall

Eligible: T2 T3 T4
 Selected:
 Sampled:
 Entry Follow Up:

MCR Questions
 Aware of requirements
 Changed recycling

General Contacts Dumpsters Schedule Sample Correlative Factors

Industry Group: Multifamily Updated Industry Group?

Physical Address
 Address: Los Feliz Dr.
 City: Any City
 State: Ca
 Zip: Bxxxx -
 Region: Southern
 Verified Physical Address
 Updated Address

How to Get to Site

Site Access Instructions:
 None

Days & Hours of Operation (military time)

	Open?	Open Time	Close Time
Sun.	<input checked="" type="checkbox"/>	0:00	0:00
Mon.	<input checked="" type="checkbox"/>	0:00	0:00
Tues.	<input checked="" type="checkbox"/>	0:00	0:00
Wed.	<input checked="" type="checkbox"/>	0:00	0:00
Thu.	<input checked="" type="checkbox"/>	0:00	0:00
Fri.	<input checked="" type="checkbox"/>	0:00	0:00
Sat.	<input checked="" type="checkbox"/>	0:00	0:00

Recruitment Notes (newest notes at top):

Record: 41005 of 113831 Unfiltered Search
 Form View

Snapshot of Multi-Family Site Recruitment Database (Page 2)

Microsoft Access

File Home Create External Data Database Tools

View Paste Copy Format Painter Filter Filter Ascending Selection Refresh Save Spelling Find Size to Switch Text Formatting

Views Clipboard Sort & Filter Records Find Window Text Formatting

frmRecruit

COS got to yes All Sampling Issues Resolved
 CCG to Yes All Data Issues Resolved
 Recruitment Data Entered Discard

CCG Recruiter: Patrick
 Date of COS Call:
 Date of CCG Call: 1/10/2014
 Requested Copy of Results:
 OK for CalRec. to Contact:

Eligible for Sampling in Season
 Winter Spring Summer Fall

 Sampled in Season
 Winter Spring Summer Fall

Eligible: T2 T3 T4
 Selected:
 Sampled:
 Entry Follow Up:

MCR Questions
 Aware of requirements
 Changed recycling

General Contacts Dumpsters Schedule Sample Correlative Factors

Stream Designation: 1 # of Containers: 2 Material Type: Curbside Garbage Material Stream Description (if Other): Hauler: Hauler Phone:

Auto ID	Container No.	Container Location & Description	Container Size	Container Type	Access Procedures	Container Locked?	Pick-up Schedule	Pick-up Frequency	Pick-up days/time
734	1	1/2 way down drive on right side in corral		dumpster	none	<input type="checkbox"/>	regular	3 per week	Sun. <input type="checkbox"/> Mon. <input type="checkbox"/> Tue. <input type="checkbox"/> Wed. <input type="checkbox"/> Thu. <input type="checkbox"/> Fri. <input type="checkbox"/> Sat. <input type="checkbox"/>
more>>									
735	2	1/2 way down drive on right side in corral		dumpster	Non	<input type="checkbox"/>	regular	3 per week	Sun. <input type="checkbox"/> Mon. <input type="checkbox"/> Tue. <input type="checkbox"/> Wed. <input type="checkbox"/> Thu. <input type="checkbox"/> Fri. <input type="checkbox"/> Sat. <input type="checkbox"/>
more>>									

Form View Num Lock

Snapshot of Multi-Family Site Recruitment Database (Page 3)

The screenshot displays the Microsoft Access interface for the 'frmRecruit' form. The ribbon includes 'File', 'Home', 'Create', 'External Data', and 'Database Tools'. The form is currently in 'Form View' and shows record 41006 of 113829, which is unfiltered.

Form Fields and Sections:

- Top Left:** Checkboxes for 'COS got to yes', 'CCG to Yes', and 'Recruitment Data Entered'.
- Top Middle:** 'All Sampling Issues Resolved' and 'All Data Issues Resolved' checkboxes, with a 'Discard' button.
- Top Right:** 'CCG Recruiter' dropdown (set to 'Patrick'), 'Date of COS Call', 'Date of CCG Call' (1/10/2014), 'Requested Copy of Results', and 'OK for CalRec. to Contact' checkbox.
- Eligible for Sampling in Season:** Grid with columns for Winter, Spring, Summer, and Fall, and rows for 'Eligible', 'Sampled', and 'Entry Follow Up'.
- MCR Questions:** Grid with columns for T2, T3, and T4, and rows for 'Selected', 'Sampled', and 'Entry Follow Up'.
- Navigation:** 'General', 'Contacts', 'Dumpsters', 'Schedule Sample', and 'Correlative Factors' tabs.
- Correlative Factors Section:**
 - ALL BUSINESSES:** Predicted Number Of Employees, Verified Total Employees (2), Verified FTE (2).
 - HOTELS:** Number of Rooms.
 - SCHOOLS K-12 only:** Number of Staff, Number of Students, Number of School Days.
 - APARTMENT BUILDINGS:** Number of Apartments (30), # of Occupied Apts (28).
 - GROUPS G and H:** How Many Sq. Ft. Occupied, Whole or Part Occupied, Enviro Certification.
 - GROUP J HOSPITAL:** Number of Beds.
 - GROUP K ARTS:** Number of Annual Visitors.
- Bottom:** 'Correlatives Complete?' checkbox (checked), 'Notes' text area, and record navigation controls.

Multi-Family Site Visit Form (page 1)

CalRecycle Statewide 2014 Multi-Family Waste Characterization Site Form

Sample Site Name:
Address:

Sample Date _____

Sampling Season (Circle one)

Winter	Spring	Summer	Fall
--------	--------	--------	------

On-Site Contact: _____

Disposal Facility: _____

Title: _____

Phone: _____

Hauler: _____

Other Contacts:

Permission: _____

Title: _____

General Phone: _____

Substream #1: MSW

Container #: _____

Description: _____

Container Type: _____

Sample Window: _____

Locked?	
Yes	No

Access Procedures: _____

Pick-Up Schedule: _____ time(s) per _____ Days (circle): Mon. Tue. Wed. Thrus. Fri. Sat. Sun.

Trash is taken out:

Container Contents Before Sampling (inches)

_____ Width _____ Length _____ Height

Container Contents After Sampling (inches)

_____ Width _____ Length _____ Height

Time of Measurements Before Sampling: _____ After Sampling: _____

Time of Last Pick-Up: _____

Multi-Family Site Visit Form (Page 2)

CalRecycle Statewide 2014 Multi-Family Waste Characterization Site Form

Substream #1: MSW

Container #: _____ Description: _____

Container Type: _____

Sample Window: _____

Locked?

Yes No

Access Procedures: _____

Pick-Up Schedule: _____ time(s) per _____ Days (circle): Mon. Tue. Wed. Thrus. Fri. Sat. Sun.

Trash is taken out:

Container Contents Before Sampling (inches)

_____ Width _____ Length _____ Height

Container Contents After Sampling (inches)

_____ Width _____ Length _____ Height

Time of Measurements Before Sampling: _____ After Sampling: _____

Time of Last Pick-Up: _____

Substream #1: MSW

Container #: _____ Description: _____

Container Type: _____

Sample Window: _____

Locked?

Yes No

Access Procedures: _____

Pick-Up Schedule: _____ time(s) per _____ Days (circle): Mon. Tue. Wed. Thrus. Fri. Sat. Sun.

Trash is taken out:

Container Contents Before Sampling (inches)

_____ Width _____ Length _____ Height

Container Contents After Sampling (inches)

_____ Width _____ Length _____ Height

Time of Measurements Before Sampling: _____ After Sampling: _____

Time of Last Pick-Up: _____

Solid Waste Facility Recruitment Script

Task 1 Recruitment Script

Facility Waste Characterization Study

Hello, my name is _____ and I am calling from CalRecycle regarding the statewide waste characterization study we're carrying out next year.

Could I please speak to the operations or facility manager about helping us out with this study?

[once the correct person is on the phone]

The reason I am calling you today is to ask for your assistance with this year's study as a sampling location.

[if we've sampled at this facility previously, mention that this will be very similar to the work we did in _____]

The quick rundown on what we need is:

- A place we can collect, sort, and dispose of 15 samples of disposed MSW, which includes putrescible waste as normally found in garbage.
- Samples will be collected from packer trucks, roll-off boxes, and self-haul vehicles and represent both residential and commercial waste streams. Does your facility receive waste from these 3 sources –
 - About 5 or more residential packer trucks per day (these are the large garbage trucks that go around neighborhoods picking up waste from houses)
 - About 5 or more commercial loads per day, from either packer trucks, compactors, or roll-offs that carry waste from businesses
 - About 5 or more loads per day from self-haulers (the public)

(Note to recruiters – Can be slightly below 5 for some sites if needed. They need to receive from all 3 sources, but don't need to receive transfer trucks. We just want to know if they do get transfer trucks, and get vehicle counts. Also, the minimums don't apply to sites in the Mountain region.)

- We would like to visit twice, either in January and July or April and October, for one to two days each visit.
- We will be collecting similar data at 25 facilities statewide and your participation would be a great help to the study.
- The data collected at your facility is aggregated with the data from other facilities and reported anonymously, though we would be happy to provide to you the composition results from your facility.

If this sounds like something you could assist us with, then I have some additional site and contact information questions that may take about 10 minutes to answer.

[If Yes, move to the Task 1 Facility Data Collection Sheet]

Solid Waste Facility Recruitment Form (Page 1)

Task 1 Facility Data Sheet—Characterization Study

Name of site: _____ Recruiter: _____

1. SCHEDULE

Dates we would like to visit. January and July (Seasons 1 and 3)
 (ask mountain sites about winter access) April and Oct (Seasons 2 and 4)

Are there any dates that definitely will not work (holidays, etc.): No Yes (list dates)

We will need the assistance of a loader to help us obtain samples from tipped loads. Is that possible? Is it available throughout the day?

2. TONNAGE & VEHICLE QUANTITIES

Does the facility have a MRF? Yes No

On average what % of loads are MRF'ed?

How many total tons of disposed waste does the facility receive daily? _____

How many tons from transfer vehicles? _____

(For transfer stations only) What is your annual throughput? _____

How many vehicles enter on a weekday, on average? (We can fax or e-mail the definitions of waste sectors to the data contact person at the facility if they are unclear.)

		Weekday Vehicle Counts	Saturday Vehicle Counts	Sunday Vehicle Counts
Transfer trucks				
Haulers with residential waste (packer trucks)				
Haulers with nonresidential waste (trucks carrying commercial, industrial, government, military, or multifamily waste)	Roll-offs			
	Packers or compactors			
Self-haul vehicles (public)				
Total Vehicle Count				

Peak times of day on a weekday?

- For transfer trucks:
- For haulers with residential waste (packer trucks):
- For haulers with nonresidential waste (packer/compactor/roll-off):
- For haulers with C&D waste:
- For self-haul vehicles, including contractors and landscapers:

Are there any days during which you do not receive waste from one of these types of loads?

**Can we have one weekday's transaction records (if yes, provide them your fax or email)?

Solid Waste Facility Recruitment Form (Page 2)

3. FACILITY CONTACT INFORMATION

Please mark the best way of contacting each person—phone, email, text, etc.

Physical address:
City, Zip:

Site owner/operator (company name or public agency name):

Person approving use of the site:
Mailing address:
City, Zip:
Phone: _____ Email: _____
Best way to contact (mark one): <input type="checkbox"/> e-mail <input type="checkbox"/> phone <input type="checkbox"/> text

Person with data about the site (if different):
Phone: _____ Email: _____
Fax: _____
Best way to contact (mark one): <input type="checkbox"/> e-mail <input type="checkbox"/> phone <input type="checkbox"/> text

On-site manager or supervisor (primary contact for logistics):
Phone: _____ Email: _____
Will this person be available for the indicated sampling period?
Best way to contact (mark one): <input type="checkbox"/> e-mail <input type="checkbox"/> phone <input type="checkbox"/> text

Contact person for crew when they arrive the morning of sampling:
Phone: _____ Email: _____
Best way to contact (mark one): <input type="checkbox"/> e-mail <input type="checkbox"/> phone <input type="checkbox"/> text

Backup contact:
Phone: _____ Email: _____
Best way to contact (mark one): <input type="checkbox"/> e-mail <input type="checkbox"/> phone <input type="checkbox"/> text

Scalehouse contact:
Phone: _____ Email: _____
Best way to contact (mark one): <input type="checkbox"/> e-mail <input type="checkbox"/> phone <input type="checkbox"/> text

Health and Safety Manager (if applicable)
Phone: _____ Email: _____
Best way to contact (mark one): <input type="checkbox"/> e-mail <input type="checkbox"/> phone <input type="checkbox"/> text

Solid Waste Facility Recruitment Form (Page 3)

Risk Management Contact (where should we send our proof of insurance?)		
Phone: _____	Email: _____	
Best way to contact (mark one):		
<input type="checkbox"/> e-mail	<input type="checkbox"/> phone	<input type="checkbox"/> text

Other Contact information notes:

SITE INFORMATION

Facility's hours of operation:

M _____
T _____
W _____
Th _____
F _____
Sat _____
Sun _____

Do you accept vehicles before opening the gate to the public?

If so, what types of vehicles and what time do they arrive?

How many entrances for MSW does your facility have? _____
How many inbound scales at each entrance? Staffed _____ Automated _____
How many outbound scales at each entrance? Staffed _____ Automated _____

Do different types of vehicles go to different gatehouses or scales- i.e., all self-haul going to one scale? If yes, please explain.

Do you close early if you have reached your allowed daily tonnage amount? Yes No

Estimate how many times per month this happens. _____/month

Should we be aware of any special projects or occasions that would result in a change in quantity or type of material entering the facility (large local construction projects, upcoming flow control changes, etc.)?

Are there site conditions we need to be aware of such as high winds, snakes or other animals, or other special circumstances?

Solid Waste Facility Recruitment Form (Page 4)

Would it be possible for the sorting crew to be there when the site is closed, for example after hours or on weekends if needed?

NET WEIGHT PROCEDURES

Do all vehicles get weighed? If not, which types of vehicles don't get weighed? Please explain how you collect net weight information for vehicles.

Drivers of loads will be surveyed at the entrance throughout the day. The survey is very brief, involving just a few questions. We also will need to collect the net weight of each vehicle that we survey. We may give the driver of each inbound vehicle a numbered card to hand to your gatehouse staff when the vehicle exits the facility. Can your gatehouse staff write the net weight of each vehicle on the card?

4. MATERIAL HANDLING

Other than MRFing, what materials are recovered at this site? How and when are vehicles diverted so that recovered materials can be separated from disposed waste?

Material	How and when diverted

The purpose of the study is to take samples of disposed wastes only. How can we sample from a vehicle after it has had materials recovered to get only materials from THAT vehicle?

Solid Waste Facility Recruitment Form (Page 5)

5. SAMPLING AND SORTING PROCEDURES

We need an area for the sorting crew to work in for the entire time we will be at the site. It should be about the size of two truck bays, or a 20 X 40 space. Can the site accommodate this? Where do you think that will be?

Is this space covered or will it be open to the elements?

If open to the elements (a landfill), could you create a make-shift "pad" for us to work on in the case of rain? Gravel, mulch, or a substrate that would make for a safer work surface?

Is there a restroom close to the worksite?

Crews have hardhats, safety vests, coveralls, boots, and gloves. Are there any other safety equipment or special procedures you want them to use?

We need access to the load for enough time to collect the sample. After a load is tipped on the ground, the sorting crew will designate which part of the load should be picked up by the loader and moved to the sorting area. We expect that it will take from two to five minutes to obtain a sample. Is this okay?

Can we leave sorting supplies and covered samples overnight if necessary?

Solid Waste Facility Recruitment Form (Page 6)

6. ADDITIONAL INFORMATION

What hauling companies do you work with primarily? Could you provide us a list with contacts either below or via email? We'd like to send them a letter so they are aware of the study.

Company:
Contact person:
Phone:
Mailing address:

Company:
Contact person:
Phone:
Mailing address:

Company:
Contact person:
Phone:
Mailing address:

In order to communicate with all drivers, we will develop translation cards that show the survey questions in several languages. What are the most common languages used by the drivers of vehicles that arrive at your facility?

___ English
___ Spanish
___ Other: _____

7. FINAL LOGISTICS

Can you please send me a plan or map of the area where you think you might set us up for sampling? (taken from permit)

Any other special circumstances we need to be aware of?

We will send you a copy of our insurance policy. Is there anything else you need from us?

Please remember to notify gate personnel of the dates we will be visiting your facility.

Cal Recycle may wish to set up site visits during sorting for staff to observe fieldwork for the project. Is this okay?

We will provide a one month and a one week reminder of our visit. We will use these reminders to finalize and verify sampling and sorting logistics and dates. Would you like any other reminders?

If we have further questions, someone from the project team (CalRecycle, Cascadia Consulting Group, or MSW Consultants) will contact you.

CalRecycle use only:

- Vehicle Counts Included/rec'd Transactions Records Received Hauler Info Included/Received
 Site Map Received Insurance Info Sent
 Other action/follow-up needed (describe): _____

Snapshot of Waste Composition Data Entry Database

The screenshot displays a Microsoft Access database window titled "Entry1 - Waste Characterization Data Entry". The interface includes a ribbon with tabs for File, Home, Create, External Data, and Database Tools. The main form area is titled "CalRecycle Data Entry" and contains the following fields and controls:

- Sample ID:** A text input field.
- Survey Information:** A section containing:
 - Site:** A dropdown menu with "Miramar" selected.
 - Date:** A date field showing "4/14/2014".
 - Day:** A dropdown menu with "Monday" selected.
 - Month:** A dropdown menu with "April" selected.
 - Weather - check if bad:** A checkbox.
 - Study Period:** A text field with "2014".
 - Season:** A dropdown menu with "2" selected.
 - Schedule ID:** A text field with "71".
- Percent Leaves:** A numeric input field with "0".
- Survey No.:** A dropdown menu with "(New)" selected.
- Comments:** A large text area for notes.
- Navigation Buttons:** A set of buttons including "ENTER SORT WEIGHT DATA FOR THIS SURVEY" (highlighted with a green box), "Go to survey:" (with "Last", "Next", and "New" sub-buttons), and a red "STOP" button.
- Site Notes:** A large empty text area.
- Go to Site:** A section with navigation buttons: "< > NEW Site/Day >>".

At the bottom of the form, there are status bars showing "Record: 1 of 1" and "Record: 1 of 15". The bottom right corner indicates "Num Lock: Filtered".

Snapshot of Vehicle Survey Data Entry Spreadsheet

Date	Survey Site	Site Size (square feet)	Survey/Interview	Page Number	All vehicles										Length (feet)	% Reported	Surveyor's Notes
					ID	Waste Type	Vehicle Type	Location	Material Reported	Generator	From Construction Site?	Net weight of Load	Net weight	Rem.			
						C - Commercial/Residential M - Municipal Sanitation CN - Contractor R - Res./Private Owner J - Junk Removal/Transfer O - Other (private) G - Government Entity	1. Truck 2. DE, Loose 3. DE, Chipped 4. Pick-up, Van 5. SUV, SUV Truck 6. Car 7. Semi Truck 8. Other	Please list the city or county that the waste came from	1. Refuse 2. C&D 3. Construction and Demolition 4. Other	1. Single Family Residential 2. Multi-Family 3. Commercial/Industrial - Commercial 4. Other	No - Not from Construction Site Yes - From Construction Site 1. Demolition 2. Excavation 3. Other	Put an 'x' in the column that represents the units of	Net weight Rem. Use Units	Put an 'x' in the box if the load was reported	If needed for net weights, record material/total lbs. tons. Enter fraction name if applicable		
3/10/2014	De Mountain	1 yd	361	0	361	CN - Contractor	0	Monterey	C&D Construction and Demolition	000				0			
3/10/2014	De Mountain	1 yd	361	0	361	R - Res./Private Owner	0	HMB	C&D Construction and Demolition	000				1.11	x		
3/10/2014	De Mountain	1 yd	361	0	361	R - Res./Private Owner	0	San Carlos	C&D Construction and Demolition	000				2.17	x		
3/10/2014	De Mountain	1 yd	361	0	371	R - Res./Private Owner	0	San Jose	R - Refuse	000				1	x		
3/10/2014	De Mountain	1 yd	361	0	374	R - Res./Private Owner	0	Woodside	R - Refuse	000				1	x		
3/10/2014	De Mountain	1 yd	361	0	384	CN - Contractor	0	San Jose	C&D Construction and Demolition	000				4.41	x		
3/10/2014	De Mountain	1 yd	361	0	387	CN - Contractor	1	San Francisco	R - Refuse	000				1.84	x		
3/10/2014	De Mountain	1 yd	361	0	389	CN - Contractor	0	Marina Village	R - Refuse	000				4.25	x		
3/10/2014	De Mountain	1 yd	361	0	403	CN - Contractor	1	Redwood	C&D Construction and Demolition	000				21.81	x		
3/10/2014	De Mountain	1 yd	361	1	409	CN - Contractor	1	Menlo Park	R - Refuse	000				1.80	x		
3/10/2014	De Mountain	1 yd	361	1	411	CN - Contractor	1	Woodside	R - Refuse	000				1.54	x		
3/10/2014	De Mountain	1 yd	361	1	426	CN - Contractor	1	Menlo Park	R - Refuse	000				1.17	x		
3/10/2014	De Mountain	1 yd	361	1	431	R - Res./Private Owner	0	San Mateo	R - Refuse	000				4.14	x		
3/10/2014	De Mountain	1 yd	361	0	471	CN - Contractor	1	Menlo Park	C&D Construction and Demolition	000				0.1	x		
3/10/2014	De Mountain	1 yd	361	0	473	CN - Contractor	1	Woodside	R - Refuse	000				1.25	x		
3/10/2014	De Mountain	1 yd	361	0	476	CN - Contractor	0	Redwood City	C&D Construction and Demolition	000				1.25	x		
3/10/2014	De Mountain	1 yd	361	1	480	CN - Contractor	0	Redwood City	C&D Construction and Demolition	000				1.25	x		
3/10/2014	De Mountain	1 yd	361	1	483	R - Res./Private Owner	0	Pacific	R - Refuse	00				1.1	x		

Appendix D: Expanded Statewide Waste Characterization Tables

This appendix contains waste composition tables using the expanded list of 82 detailed *material types*. Definitions of the types can be found in Appendix B: List and Definitions of Material Types.

Overall Disposed Waste Stream

Table 45: Ten Most Prevalent Material Types in California's Overall Disposed Waste Stream Using Expanded Material Types

Material	Estimated Percent	Cumulative Percent	Estimated Tons
Food	18.1%	18.1%	5,591,179
Remainder/Composite Paper - Compostable	6.6%	24.7%	2,024,520
Other Wood Waste	4.9%	29.6%	1,527,318
Bulky Items	4.4%	34.0%	1,365,340
Remainder/Composite Organic	4.3%	38.3%	1,323,465
Textiles	4.0%	42.3%	1,234,711
Leaves and Grass	3.8%	46.1%	1,172,925
Other Miscellaneous Paper - Other	3.7%	49.9%	1,146,978
Clean Dimensional Lumber	3.2%	53.0%	976,096
Uncoated Corrugated Cardboard	3.1%	56.1%	964,942
Total	56.1%		17,327,474

Any differences between *cumulative percent* figures and the sum of *estimated percent* figures are due to rounding. The above table was constructed using sector percentage data obtained from the 2014 vehicle surveys applied to 2014 composition results. See *Special Note Regarding Sector Percentages* on Page 3 for a further explanation of the sector percentage issues.

Table 46: Composition of California's Overall Disposed Waste Stream Using Expanded Material Types

Material	Est. Using 2014 Sector Percentages			Est. Using 2008 Sector Percentages		
	Estimated Percent	+ / -	Estimated Tons	Estimated Percent	+ / -	Estimated Tons
Paper	17.4%		5,367,734	16.8%		5,176,996
Uncoated Corrugated Cardboard	3.1%	0.8%	964,942	3.7%	1.1%	1,152,480
Paper Bags	0.2%	0.1%	70,627	0.2%	0.1%	62,259
Newspaper	1.2%	0.6%	372,966	0.9%	0.5%	285,517
White Ledger Paper	0.4%	0.2%	121,637	0.4%	0.2%	132,219
Other Office Paper	0.3%	0.1%	103,845	0.3%	0.1%	89,177
Magazines and Catalogs	0.6%	0.1%	178,166	0.5%	0.1%	158,407
Phone Books and Directories	0.0%	0.0%	14,583	0.0%	0.0%	13,590
Other Miscellaneous Paper - Compostable	0.2%	0.1%	68,942	0.2%	0.1%	67,368
Other Miscellaneous Paper - Other	3.7%	0.8%	1,146,978	3.6%	0.8%	1,097,308
Remainder/Composite Paper - Rigid Food & Beverage Cartons	0.3%	0.1%	104,408	0.4%	0.2%	109,844
Remainder/Composite Paper - Compostable	6.6%	1.2%	2,024,520	5.8%	1.2%	1,801,085
Remainder/Composite Paper - Other	0.6%	0.1%	196,120	0.7%	0.2%	207,743
Glass	2.5%		764,162	2.5%		770,530
Clear Glass Bottles and Containers - CRV	0.3%	0.1%	106,764	0.3%	0.1%	99,029
Clear Glass Bottles and Containers - Non-CRV	0.5%	0.1%	156,675	0.4%	0.1%	126,535
Green Glass Bottles and Containers - CRV	0.1%	0.0%	16,252	0.0%	0.0%	14,003
Green Glass Bottles and Containers - Non-CRV	0.2%	0.1%	55,130	0.1%	0.1%	43,932
Brown Glass Bottles and Containers - CRV	0.3%	0.1%	80,742	0.2%	0.1%	68,814
Brown Glass Bottles and Containers - Non-CRV	0.1%	0.1%	30,690	0.1%	0.1%	35,361
Other Colored Glass Bottles and Containers - CRV	0.0%	0.0%	2,716	0.0%	0.0%	2,307
Other Colored Glass Bottles and Containers - Non-CRV	0.0%	0.0%	9,469	0.0%	0.0%	9,537
Flat Glass	0.1%	0.1%	42,481	0.2%	0.2%	56,510
Remainder/Composite Glass	0.9%	1.0%	263,243	1.0%	1.3%	314,504
Metal	3.1%		957,027	3.1%		964,502
Tin/Steel Cans - CRV Bimetal Containers	0.1%	0.1%	18,006	0.1%	0.1%	16,796
Tin/Steel Cans - Other	0.6%	0.1%	186,443	0.5%	0.2%	169,626
Major Appliances	0.2%	0.2%	50,251	0.1%	0.1%	29,000
Used Oil Filters	0.0%	0.0%	1,255	0.0%	0.0%	1,098
Other Ferrous	0.8%	0.2%	248,593	0.9%	0.3%	267,932
Aluminum Cans - CRV	0.1%	0.0%	30,902	0.1%	0.0%	29,399
Aluminum Cans - Non-CRV	0.1%	0.0%	16,332	0.0%	0.0%	13,297
Other Non-Ferrous	0.5%	0.2%	157,478	0.6%	0.3%	181,009
Remainder/Composite Metal	0.8%	0.2%	247,768	0.8%	0.3%	256,344
Electronics	0.9%		273,878	0.7%		230,498
Brown Goods	0.3%	0.2%	84,415	0.2%	0.1%	75,142
Computer-related Electronics	0.1%	0.1%	45,648	0.1%	0.1%	41,339
Other Small Consumer Electronics	0.2%	0.1%	68,932	0.2%	0.1%	54,457
Video Display Devices - CRT	0.2%	0.1%	46,659	0.1%	0.1%	38,881
Video Display Devices - Other	0.1%	0.1%	28,224	0.1%	0.1%	20,679
Plastic	10.4%		3,215,943	10.4%		3,203,542
PETE Containers - CRV	0.3%	0.1%	84,803	0.3%	0.1%	77,850
PETE Containers - Non-CRV	0.4%	0.1%	112,399	0.3%	0.1%	101,679
HDPE Containers - CRV	0.0%	0.0%	11,386	0.0%	0.0%	12,368
HDPE Containers - Non-CRV	0.4%	0.1%	127,803	0.4%	0.1%	124,325
Miscellaneous Plastic Containers - CRV	0.0%	0.0%	7,064	0.0%	0.0%	4,426
Miscellaneous Plastic Containers - Non-CRV	0.5%	0.1%	166,673	0.5%	0.1%	160,917
Plastic Trash Bags	1.2%	0.1%	383,130	1.2%	0.2%	379,315
Plastic Grocery and Other Merchandise Bags	0.5%	0.1%	157,395	0.4%	0.0%	128,298
Non-Bag Commercial and Industrial Packaging Film	0.3%	0.1%	83,192	0.3%	0.1%	102,661
Film Products	0.2%	0.3%	73,394	0.4%	0.5%	118,895
Other Film - Flexible Plastic Pouches	0.1%	0.1%	43,173	0.1%	0.1%	33,866
Other Film - Other	1.6%	0.2%	500,304	1.6%	0.2%	489,345
Durable Plastic Items - #2 and #5 Bulky Rigid	0.7%	0.3%	212,226	0.7%	0.3%	228,504
Durable Plastic Items - Other	1.5%	0.4%	470,585	1.4%	0.4%	442,709
Remainder/Composite Plastic	2.5%	0.3%	782,415	2.6%	0.5%	798,384

Confidence intervals calculated at the 90% confidence level. Percentages for material types may not total 100% due to rounding.

Table 46 (continued): Composition of California's Overall Disposed Waste Stream Using Expanded Material Types

Material	Est. Using 2014 Sector Percentages			Est. Using 2008 Sector Percentages		
	Estimated Percent	+ / -	Estimated Tons	Estimated Percent	+ / -	Estimated Tons
Other Organic	37.4%		11,558,054	34.4%		10,614,389
Food	18.1%	1.6%	5,591,179	16.5%	1.8%	5,083,364
Leaves and Grass	3.8%	1.2%	1,172,925	3.4%	1.3%	1,048,621
Prunings and Trimmings	3.1%	1.0%	962,262	2.8%	1.0%	868,512
Branches and Stumps	1.7%	0.9%	528,493	1.8%	1.0%	544,872
Manures	0.6%	0.6%	174,808	0.7%	0.7%	214,875
Textiles	4.0%	0.7%	1,234,711	3.6%	0.7%	1,114,224
Carpet	1.8%	0.6%	570,212	2.0%	0.7%	605,950
Remainder/Composite Organic	4.3%	0.5%	1,323,465	3.7%	0.5%	1,133,971
Inerts and Other	19.9%		6,132,838	23.5%		7,265,537
Concrete	1.2%	0.4%	373,185	1.3%	0.5%	415,287
Asphalt Paving	0.2%	0.3%	70,269	0.4%	0.7%	130,364
Asphalt Roofing	0.7%	0.4%	223,236	0.8%	0.6%	251,150
Clean Dimensional Lumber	3.2%	1.1%	976,096	3.5%	1.3%	1,089,951
Clean Engineered Wood	1.7%	0.6%	523,223	1.9%	0.7%	571,507
Clean Pallets & Crates	2.1%	0.6%	650,072	3.0%	1.0%	916,881
Other Wood Waste	4.9%	1.0%	1,527,318	5.3%	0.9%	1,650,732
Gypsum Board	1.1%	0.4%	327,002	1.3%	0.5%	401,684
Rock, Soil and Fines	2.4%	0.7%	750,357	2.9%	1.0%	896,129
Remainder/Composite Inerts and Other	2.3%	0.7%	712,079	3.1%	1.1%	941,853
Household Hazardous Waste (HHW)	0.4%		109,568	0.3%		78,461
Paint	0.2%	0.1%	48,951	0.1%	0.1%	31,414
Vehicle and Equipment Fluids	0.0%	0.0%	219	0.0%	0.0%	88
Used Oil	0.0%	0.0%	1,410	0.0%	0.0%	939
Batteries	0.0%	0.0%	11,887	0.0%	0.0%	10,894
Mercury-Containing Items - Not Lamps	0.0%	0.0%	8	0.0%	0.0%	7
Lamps - Fluorescent and LED	0.0%	0.0%	8,228	0.0%	0.0%	7,277
Remainder/Composite Household Hazardous	0.1%	0.1%	38,865	0.1%	0.0%	27,840
Special Waste	5.0%		1,558,079	5.8%		1,803,511
Ash	0.1%	0.0%	16,138	0.1%	0.1%	17,409
Treated Medical Waste	0.1%	0.2%	34,909	0.1%	0.1%	30,645
Bulky Items	4.4%	1.3%	1,365,340	5.1%	1.4%	1,574,149
Tires	0.1%	0.1%	39,393	0.1%	0.1%	39,308
Remainder/Composite Special Waste	0.3%	0.3%	102,299	0.5%	0.4%	142,000
Mixed Residue	3.0%		926,996	2.5%		756,314
Totals	100.0%		30,864,279	100.0%		30,864,279
Sample Count	754			754		

Confidence intervals calculated at the 90% confidence level. Percentages for material types may not total 100% due to rounding.

The above table presents the 2014 sector percentages applied to the 2014 waste composition data and, for comparison, the sector percentages obtained in the 2008 Statewide Waste Characterization Study applied to the 2014 waste composition data. See *Special Note Regarding Sector Percentages* on Page 3 for a further explanation of the sector percentage issues.

Franchised Commercial Waste

Table 47: Ten Most Prevalent Material Types in Franchised Commercial Disposed Waste Using Expanded Material Types

Material	Estimated Percent	Cumulative Percent	Estimated Tons
Food	20.1%	20.1%	2,390,922
Remainder/Composite Paper - Compostable	7.2%	27.3%	858,580
Uncoated Corrugated Cardboard	5.0%	32.3%	594,130
Clean Dimensional Lumber	4.2%	36.5%	503,772
Other Miscellaneous Paper - Other	4.2%	40.7%	496,714
Bulky Items	3.8%	44.5%	457,451
Leaves and Grass	3.2%	47.7%	377,741
Textiles	3.1%	50.8%	365,829
Clean Pallets & Crates	3.1%	53.8%	365,769
Other Wood Waste	3.0%	56.8%	357,042
Total	56.8%		6,767,952

Any differences between *cumulative percent* figures and the sum of *estimated percent* figures are due to rounding. The above table was constructed using sector percentage data obtained from the 2014 vehicle surveys applied to 2014 composition results. See *Special Note Regarding Sector Percentages* on Page 3 for a further explanation of the sector percentage issues.

Table 48: Composition of Franchised Commercial Disposed Waste Using Expanded Material Types

Material	Est. Using 2014 Sector Percentages			Est. Using 2008 Sector Percentages		
	Estimated Percent	+ / -	Estimated Tons	Estimated Percent	+ / -	Estimated Tons
Paper	20.4%		2,433,919	20.4%		3,125,821
Uncoated Corrugated Cardboard	5.0%	1.8%	594,130	5.5%	2.1%	834,744
Paper Bags	0.2%	0.1%	20,301	0.2%	0.1%	24,107
Newspaper	0.5%	0.3%	64,998	0.5%	0.2%	74,164
White Ledger Paper	0.7%	0.4%	79,000	0.7%	0.4%	103,180
Other Office Paper	0.3%	0.2%	36,780	0.3%	0.2%	47,225
Magazines and Catalogs	0.6%	0.2%	70,156	0.6%	0.2%	85,920
Phone Books and Directories	0.0%	0.0%	5,345	0.0%	0.0%	5,982
Other Miscellaneous Paper - Compostable	0.4%	0.3%	42,103	0.3%	0.2%	49,958
Other Miscellaneous Paper - Other	4.2%	1.4%	496,714	4.3%	1.5%	655,742
Remainder/Composite Paper - Rigid Food & Beverage Cartons	0.5%	0.3%	65,439	0.6%	0.3%	84,762
Remainder/Composite Paper - Compostable	7.2%	2.2%	858,580	6.7%	2.1%	1,027,818
Remainder/Composite Paper - Other	0.8%	0.3%	100,373	0.9%	0.3%	132,219
Glass	3.3%		396,766	3.3%		504,813
Clear Glass Bottles and Containers - CRV	0.4%	0.2%	46,677	0.4%	0.2%	55,896
Clear Glass Bottles and Containers - Non-CRV	0.4%	0.1%	42,612	0.3%	0.1%	50,287
Green Glass Bottles and Containers - CRV	0.1%	0.0%	6,149	0.0%	0.0%	7,306
Green Glass Bottles and Containers - Non-CRV	0.2%	0.1%	19,588	0.2%	0.1%	23,877
Brown Glass Bottles and Containers - CRV	0.2%	0.1%	24,720	0.2%	0.1%	30,127
Brown Glass Bottles and Containers - Non-CRV	0.1%	0.2%	15,198	0.2%	0.2%	24,481
Other Colored Glass Bottles and Containers - CRV	0.0%	0.0%	228	0.0%	0.0%	349
Other Colored Glass Bottles and Containers - Non-CRV	0.0%	0.0%	5,920	0.1%	0.0%	7,683
Flat Glass	0.1%	0.2%	17,752	0.2%	0.3%	30,519
Remainder/Composite Glass	1.8%	2.7%	217,921	1.8%	2.6%	274,288
Metal	3.3%		388,592	3.3%		509,642
Tin/Steel Cans - CRV Bimetal Containers	0.1%	0.1%	6,659	0.1%	0.1%	8,182
Tin/Steel Cans - Other	0.6%	0.3%	65,971	0.6%	0.3%	86,602
Major Appliances	0.1%	0.2%	11,579	0.1%	0.1%	9,933
Used Oil Filters	0.0%	0.0%	571	0.0%	0.0%	530
Other Ferrous	1.0%	0.5%	116,050	1.0%	0.6%	159,457
Aluminum Cans - CRV	0.1%	0.0%	14,455	0.1%	0.0%	17,717
Aluminum Cans - Non-CRV	0.0%	0.0%	3,395	0.0%	0.0%	4,170
Other Non-Ferrous	0.6%	0.5%	70,831	0.7%	0.6%	106,687
Remainder/Composite Metal	0.8%	0.5%	99,081	0.8%	0.5%	116,364
Electronics	0.8%		90,112	0.6%		98,418
Brown Goods	0.3%	0.2%	39,470	0.3%	0.2%	48,314
Computer-related Electronics	0.1%	0.1%	12,304	0.1%	0.1%	15,745
Other Small Consumer Electronics	0.1%	0.0%	7,998	0.1%	0.0%	8,679
Video Display Devices - CRT	0.2%	0.2%	17,951	0.1%	0.1%	15,230
Video Display Devices - Other	0.1%	0.2%	12,388	0.1%	0.1%	10,450
Plastic	12.5%		1,491,458	12.5%		1,911,140
PETE Containers - CRV	0.3%	0.1%	37,879	0.3%	0.1%	46,264
PETE Containers - Non-CRV	0.4%	0.3%	44,487	0.4%	0.3%	55,039
HDPE Containers - CRV	0.1%	0.1%	7,734	0.1%	0.1%	9,542
HDPE Containers - Non-CRV	0.5%	0.2%	60,616	0.5%	0.2%	79,506
Miscellaneous Plastic Containers - CRV	0.0%	0.0%	569	0.0%	0.0%	719
Miscellaneous Plastic Containers - Non-CRV	0.7%	0.3%	80,096	0.7%	0.3%	100,656
Plastic Trash Bags	1.7%	0.3%	208,401	1.7%	0.3%	257,351
Plastic Grocery and Other Merchandise Bags	0.3%	0.1%	41,200	0.3%	0.1%	50,313
Non-Bag Commercial and Industrial Packaging Film	0.5%	0.2%	60,149	0.6%	0.2%	84,731
Film Products	0.5%	0.7%	59,992	0.7%	1.0%	99,783
Other Film - Flexible Plastic Pouches	0.1%	0.0%	8,123	0.1%	0.0%	9,993
Other Film - Other	2.0%	0.3%	243,445	2.0%	0.3%	306,823
Durable Plastic Items - #2 and #5 Bulky Rigid	1.1%	0.6%	134,782	1.1%	0.6%	170,593
Durable Plastic Items - Other	1.6%	0.8%	192,715	1.5%	0.8%	231,498
Remainder/Composite Plastic	2.6%	0.5%	311,270	2.7%	0.6%	408,328

Confidence intervals calculated at the 90% confidence level. Percentages for material types may not total 100% due to rounding.

Table 48 (continued): Composition of Franchised Commercial Disposed Waste Using Expanded Material Types

Material	Est. Using 2014 Sector Percentages			Est. Using 2008 Sector Percentages		
	Estimated Percent	+ / -	Estimated Tons	Estimated Percent	+ / -	Estimated Tons
Other Organic	34.8%		4,145,711	33.5%		5,129,480
Food	20.1%	3.6%	2,390,922	18.9%	3.5%	2,898,430
Leaves and Grass	3.2%	2.2%	377,741	3.2%	2.2%	493,850
Prunings and Trimmings	1.8%	1.2%	211,250	1.7%	1.2%	266,838
Branches and Stumps	1.7%	1.7%	208,413	1.8%	1.7%	270,765
Manures	1.3%	1.4%	150,455	1.2%	1.4%	190,421
Textiles	3.1%	1.2%	365,829	3.1%	1.2%	470,895
Carpet	1.0%	0.9%	115,547	0.9%	0.9%	145,080
Remainder/Composite Organic	2.7%	0.7%	325,554	2.6%	0.7%	393,202
Inerts and Other	17.9%		2,132,837	19.1%		2,917,350
Concrete	0.8%	0.4%	91,170	0.8%	0.4%	116,687
Asphalt Paving	0.0%	0.1%	4,779	0.0%	0.1%	7,160
Asphalt Roofing	0.7%	0.8%	79,640	0.8%	1.1%	127,424
Clean Dimensional Lumber	4.2%	2.3%	503,772	4.3%	2.4%	660,478
Clean Engineered Wood	1.8%	0.8%	213,246	1.7%	0.8%	264,447
Clean Pallets & Crates	3.1%	1.2%	365,769	3.7%	1.5%	572,509
Other Wood Waste	3.0%	1.1%	357,042	3.1%	1.2%	476,730
Gypsum Board	0.8%	0.5%	94,022	0.7%	0.4%	109,892
Rock, Soil and Fines	1.9%	1.0%	230,508	2.2%	1.2%	334,418
Remainder/Composite Inerts and Other	1.6%	1.1%	192,888	1.6%	1.1%	247,605
Household Hazardous Waste (HHW)	0.4%		41,716	0.3%		39,885
Paint	0.2%	0.3%	22,987	0.1%	0.2%	20,648
Vehicle and Equipment Fluids	0.0%	0.0%	0	0.0%	0.0%	0
Used Oil	0.0%	0.0%	661	0.0%	0.0%	565
Batteries	0.0%	0.0%	3,130	0.0%	0.0%	3,722
Mercury-Containing Items - Not Lamps	0.0%	0.0%	0	0.0%	0.0%	0
Lamps - Fluorescent and LED	0.0%	0.0%	1,206	0.0%	0.0%	1,790
Remainder/Composite Household Hazardous	0.1%	0.1%	13,732	0.1%	0.1%	13,160
Special Waste	4.8%		568,604	5.2%		796,806
Ash	0.1%	0.1%	11,407	0.1%	0.1%	13,755
Treated Medical Waste	0.0%	0.1%	5,118	0.1%	0.1%	7,668
Bulky Items	3.8%	1.8%	457,451	4.2%	1.9%	637,312
Tires	0.0%	0.0%	4,238	0.0%	0.1%	6,026
Remainder/Composite Special Waste	0.8%	0.7%	90,389	0.9%	0.8%	132,045
Mixed Residue	1.8%		220,222	1.8%		268,138
Totals	100.0%		11,909,937	100.0%		15,301,492
Sample Count	251			251		

Confidence intervals calculated at the 90% confidence level. Percentages for material types may not total 100% due to rounding.

The above table presents the 2014 sector percentages applied to the 2014 waste composition data and, for comparison, the sector percentages obtained in the 2008 Statewide Waste Characterization Study applied to the 2014 waste composition data. See *Special Note Regarding Sector Percentages* on Page 3 for a further explanation of the sector percentage issues.

Franchised Residential Waste

Table 49: Ten Most Prevalent Material Types in Franchised Residential Disposed Waste Using Expanded Material Types

Material	Estimated Percent	Cumulative Percent	Estimated Tons
Food	21.9%	21.9%	3,181,722
Remainder/Composite Paper - Compostable	8.0%	29.9%	1,158,007
Remainder/Composite Organic	6.5%	36.4%	940,299
Textiles	5.5%	41.9%	796,134
Mixed Residue	4.8%	46.6%	690,941
Leaves and Grass	4.6%	51.2%	663,657
Other Miscellaneous Paper - Other	4.3%	55.5%	625,546
Prunings and Trimmings	3.8%	59.3%	553,083
Other Wood Waste	3.6%	62.9%	515,802
Bulky Items	2.8%	65.6%	400,375
Total	65.6%		9,525,564

Any differences between *cumulative percent* figures and the sum of *estimated percent* figures are due to rounding. The above table was constructed using sector percentage data obtained from the 2014 vehicle surveys applied to 2014 composition results. See *Special Note Regarding Sector Percentages* on Page 3 for a further explanation of the sector percentage issues.

Table 50: Composition of Franchised Residential Disposed Waste Using Expanded Material Types

Material	Est. Using 2014 Sector Percentages			Est. Using 2008 Sector Percentages		
	Estimated Percent	+ / -	Estimated Tons	Estimated Percent	+ / -	Estimated Tons
Paper	19.2%		2,787,295	19.9%		1,844,685
Uncoated Corrugated Cardboard	2.0%	0.8%	286,560	2.1%	0.9%	193,069
Paper Bags	0.3%	0.1%	44,643	0.3%	0.1%	32,180
Newspaper	2.1%	1.3%	306,380	2.3%	1.5%	209,092
White Ledger Paper	0.3%	0.1%	40,663	0.3%	0.1%	26,965
Other Office Paper	0.5%	0.2%	65,843	0.4%	0.2%	40,700
Magazines and Catalogs	0.7%	0.2%	103,513	0.7%	0.1%	67,608
Phone Books and Directories	0.0%	0.0%	6,393	0.0%	0.0%	3,911
Other Miscellaneous Paper - Compostable	0.2%	0.1%	26,636	0.2%	0.1%	17,160
Other Miscellaneous Paper - Other	4.3%	1.1%	625,546	4.4%	1.2%	405,224
Remainder/Composite Paper - Rigid Food & Beverage Cartons	0.3%	0.1%	38,670	0.3%	0.1%	24,708
Remainder/Composite Paper - Compostable	8.0%	1.9%	1,158,007	8.2%	1.8%	762,167
Remainder/Composite Paper - Other	0.6%	0.2%	84,441	0.7%	0.2%	61,900
Glass	2.2%		320,710	2.3%		212,099
Clear Glass Bottles and Containers - CRV	0.4%	0.1%	57,263	0.4%	0.1%	39,924
Clear Glass Bottles and Containers - Non-CRV	0.8%	0.1%	112,147	0.8%	0.1%	73,854
Green Glass Bottles and Containers - CRV	0.1%	0.0%	9,597	0.1%	0.0%	6,095
Green Glass Bottles and Containers - Non-CRV	0.2%	0.1%	35,393	0.2%	0.1%	19,888
Brown Glass Bottles and Containers - CRV	0.4%	0.1%	53,487	0.4%	0.2%	35,926
Brown Glass Bottles and Containers - Non-CRV	0.1%	0.0%	15,370	0.1%	0.0%	10,741
Other Colored Glass Bottles and Containers - CRV	0.0%	0.0%	2,476	0.0%	0.0%	1,940
Other Colored Glass Bottles and Containers - Non-CRV	0.0%	0.0%	3,504	0.0%	0.0%	1,811
Flat Glass	0.0%	0.0%	2,426	0.0%	0.0%	2,063
Remainder/Composite Glass	0.2%	0.1%	29,048	0.2%	0.1%	19,858
Metal	2.9%		415,855	2.8%		258,576
Tin/Steel Cans - CRV Bimetal Containers	0.1%	0.1%	11,265	0.1%	0.1%	8,452
Tin/Steel Cans - Other	0.8%	0.2%	110,680	0.8%	0.2%	72,781
Major Appliances	0.2%	0.4%	34,497	0.2%	0.2%	13,941
Used Oil Filters	0.0%	0.0%	551	0.0%	0.0%	265
Other Ferrous	0.6%	0.2%	89,116	0.6%	0.2%	54,103
Aluminum Cans - CRV	0.1%	0.0%	16,105	0.1%	0.0%	11,244
Aluminum Cans - Non-CRV	0.1%	0.0%	12,904	0.1%	0.1%	9,081
Other Non-Ferrous	0.4%	0.2%	65,004	0.4%	0.1%	39,371
Remainder/Composite Metal	0.5%	0.2%	75,733	0.5%	0.1%	49,338
Electronics	1.1%		160,785	1.1%		104,806
Brown Goods	0.3%	0.3%	41,356	0.2%	0.2%	23,050
Computer-related Electronics	0.2%	0.1%	24,900	0.2%	0.1%	17,046
Other Small Consumer Electronics	0.4%	0.1%	55,080	0.4%	0.1%	36,840
Video Display Devices - CRT	0.2%	0.2%	24,279	0.2%	0.2%	19,155
Video Display Devices - Other	0.1%	0.1%	15,169	0.1%	0.1%	8,715
Plastic	10.2%		1,485,047	10.6%		982,590
PETE Containers - CRV	0.3%	0.1%	45,715	0.3%	0.1%	30,073
PETE Containers - Non-CRV	0.4%	0.1%	64,769	0.5%	0.1%	43,325
HDPE Containers - CRV	0.0%	0.0%	3,481	0.0%	0.0%	2,597
HDPE Containers - Non-CRV	0.5%	0.1%	66,521	0.5%	0.1%	43,958
Miscellaneous Plastic Containers - CRV	0.0%	0.0%	6,494	0.0%	0.0%	3,705
Miscellaneous Plastic Containers - Non-CRV	0.6%	0.2%	85,752	0.6%	0.2%	59,314
Plastic Trash Bags	1.2%	0.1%	170,878	1.3%	0.1%	116,399
Plastic Grocery and Other Merchandise Bags	0.8%	0.1%	115,352	0.8%	0.1%	77,032
Non-Bag Commercial and Industrial Packaging Film	0.1%	0.1%	19,648	0.2%	0.1%	14,243
Film Products	0.0%	0.0%	5,056	0.0%	0.1%	4,392
Other Film - Flexible Plastic Pouches	0.2%	0.1%	34,917	0.3%	0.2%	23,699
Other Film - Other	1.7%	0.2%	250,835	1.9%	0.2%	174,645
Durable Plastic Items - #2 and #5 Bulky Rigid	0.4%	0.2%	65,176	0.5%	0.2%	45,098
Durable Plastic Items - Other	1.3%	0.5%	189,413	1.1%	0.3%	103,819
Remainder/Composite Plastic	2.5%	0.3%	361,040	2.6%	0.4%	240,292

Confidence intervals calculated at the 90% confidence level. Percentages for material types may not total 100% due to rounding.

Table 50 (continued): Composition of Franchised Residential Disposed Waste Using Expanded Material Types

Material	Est. Using 2014 Sector Percentages			Est. Using 2008 Sector Percentages		
	Estimated Percent	+ / -	Estimated Tons	Estimated Percent	+ / -	Estimated Tons
Other Organic	45.2%		6,568,469	45.3%		4,195,576
Food	21.9%	1.8%	3,181,722	23.4%	1.7%	2,161,842
Leaves and Grass	4.6%	1.7%	663,657	3.7%	1.2%	343,107
Prunings and Trimmings	3.8%	1.6%	553,083	2.9%	1.1%	265,433
Branches and Stumps	1.5%	1.3%	211,735	1.0%	0.8%	96,134
Manures	0.0%	0.0%	3,164	0.0%	0.0%	3,224
Textiles	5.5%	1.1%	796,134	5.9%	1.3%	547,039
Carpet	1.5%	0.8%	218,677	1.4%	0.7%	133,515
Remainder/Composite Organic	6.5%	0.8%	940,299	7.0%	0.8%	645,282
Inerts and Other	10.8%		1,563,611	9.3%		859,714
Concrete	0.8%	0.5%	110,983	0.7%	0.3%	60,694
Asphalt Paving	0.0%	0.0%	0	0.0%	0.0%	0
Asphalt Roofing	0.5%	0.5%	65,708	0.3%	0.3%	29,727
Clean Dimensional Lumber	1.6%	1.3%	227,000	1.2%	0.9%	106,700
Clean Engineered Wood	0.9%	0.8%	126,494	0.6%	0.5%	57,325
Clean Pallets & Crates	0.8%	0.7%	111,180	0.8%	0.8%	76,056
Other Wood Waste	3.6%	1.8%	515,802	3.3%	1.3%	305,634
Gypsum Board	0.3%	0.2%	40,795	0.3%	0.1%	26,760
Rock, Soil and Fines	1.8%	0.6%	256,402	1.4%	0.4%	131,074
Remainder/Composite Inerts and Other	0.8%	0.4%	109,246	0.7%	0.3%	65,744
Household Hazardous Waste (HHW)	0.5%		66,169	0.4%		36,596
Paint	0.2%	0.2%	25,885	0.1%	0.1%	10,686
Vehicle and Equipment Fluids	0.0%	0.0%	219	0.0%	0.0%	88
Used Oil	0.0%	0.0%	711	0.0%	0.0%	287
Batteries	0.1%	0.0%	8,500	0.1%	0.0%	6,827
Mercury-Containing Items - Not Lamps	0.0%	0.0%	8	0.0%	0.0%	7
Lamps - Fluorescent and LED	0.0%	0.1%	6,976	0.1%	0.1%	5,436
Remainder/Composite Household Hazardous	0.2%	0.1%	23,870	0.1%	0.1%	13,265
Special Waste	3.2%		457,330	3.1%		288,137
Ash	0.0%	0.0%	3,944	0.0%	0.0%	2,838
Treated Medical Waste	0.2%	0.3%	29,791	0.2%	0.4%	22,977
Bulky Items	2.8%	1.9%	400,375	2.6%	1.6%	242,907
Tires	0.1%	0.1%	11,368	0.1%	0.2%	9,533
Remainder/Composite Special Waste	0.1%	0.0%	11,852	0.1%	0.1%	9,883
Mixed Residue	4.8%		690,941	5.1%		471,223
Totals	100.0%		14,516,212	100.0%		9,254,001
Sample Count	253			253		

Confidence intervals calculated at the 90% confidence level. Percentages for material types may not total 100% due to rounding.

The above table presents the 2014 sector percentages applied to the 2014 waste composition data and, for comparison, the sector percentages obtained in the 2008 Statewide Waste Characterization Study applied to the 2014 waste composition data. See *Special Note Regarding Sector Percentages* on Page 3 for a further explanation of the sector percentage issues.

Single-Family Residential Waste

Table 51: Ten Most Prevalent Material Types in Single-Family Residential Disposed Waste Using Expanded Material Types

Material	Estimated Percent	Cumulative Percent	Estimated Tons
Food	21.0%	21.0%	2,293,394
Remainder/Composite Paper - Compostable	8.4%	29.4%	913,551
Remainder/Composite Organic	6.3%	35.6%	685,129
Mixed Residue	5.1%	40.8%	562,072
Leaves and Grass	5.1%	45.9%	561,346
Prunings and Trimmings	4.8%	50.7%	523,588
Textiles	4.8%	55.5%	522,698
Other Miscellaneous Paper - Other	4.1%	59.6%	453,151
Other Wood Waste	4.0%	63.7%	441,869
Bulky Items	2.7%	66.4%	294,460
Total	66.4%		7,251,258

Any differences between *cumulative percent* figures and the sum of *estimated percent* figures are due to rounding. The above table was constructed using sector percentage data obtained from the 2014 vehicle surveys applied to 2014 composition results. See *Special Note Regarding Sector Percentages* on Page 3 for a further explanation of the sector percentage issues.

Table 52: Composition of Single-Family Residential Disposed Waste Using Expanded Material Types

Material	Est. Using 2014 Sector Percentages			Est. Using 2008 Sector Percentages		
	Estimated Percent	+ / -	Estimated Tons	Estimated Percent	+ / -	Estimated Tons
Paper	17.7%		1,928,489	18.2%		1,214,855
Uncoated Corrugated Cardboard	1.4%	0.5%	157,394	1.5%	0.5%	100,861
Paper Bags	0.2%	0.1%	24,533	0.3%	0.1%	17,223
Newspaper	1.2%	0.4%	127,089	1.1%	0.3%	73,948
White Ledger Paper	0.2%	0.1%	22,491	0.2%	0.1%	13,230
Other Office Paper	0.4%	0.2%	46,367	0.4%	0.2%	26,634
Magazines and Catalogs	0.7%	0.2%	76,772	0.7%	0.2%	47,817
Phone Books and Directories	0.1%	0.0%	5,530	0.1%	0.0%	3,392
Other Miscellaneous Paper - Compostable	0.2%	0.1%	16,997	0.2%	0.0%	11,086
Other Miscellaneous Paper - Other	4.1%	1.1%	453,151	4.2%	1.0%	279,121
Remainder/Composite Paper - Rigid Food & Beverage Cartons	0.2%	0.1%	27,267	0.2%	0.1%	16,106
Remainder/Composite Paper - Compostable	8.4%	2.2%	913,551	8.8%	1.9%	583,833
Remainder/Composite Paper - Other	0.5%	0.1%	57,347	0.6%	0.2%	41,604
Glass	1.9%		212,316	2.0%		134,240
Clear Glass Bottles and Containers - CRV	0.3%	0.1%	27,653	0.3%	0.1%	18,347
Clear Glass Bottles and Containers - Non-CRV	0.8%	0.1%	83,363	0.8%	0.1%	53,010
Green Glass Bottles and Containers - CRV	0.1%	0.0%	7,423	0.1%	0.0%	4,468
Green Glass Bottles and Containers - Non-CRV	0.3%	0.1%	32,936	0.3%	0.1%	18,157
Brown Glass Bottles and Containers - CRV	0.3%	0.1%	32,855	0.3%	0.1%	20,515
Brown Glass Bottles and Containers - Non-CRV	0.1%	0.0%	11,375	0.1%	0.1%	7,846
Other Colored Glass Bottles and Containers - CRV	0.0%	0.0%	120	0.0%	0.0%	122
Other Colored Glass Bottles and Containers - Non-CRV	0.0%	0.0%	3,398	0.0%	0.0%	1,733
Flat Glass	0.0%	0.0%	917	0.0%	0.0%	834
Remainder/Composite Glass	0.1%	0.0%	12,276	0.1%	0.0%	9,208
Metal	2.7%		298,761	2.8%		183,303
Tin/Steel Cans - CRV Bimetal Containers	0.0%	0.0%	2,426	0.0%	0.0%	1,634
Tin/Steel Cans - Other	0.8%	0.2%	85,977	0.8%	0.2%	55,290
Major Appliances	0.3%	0.5%	34,494	0.2%	0.3%	13,940
Used Oil Filters	0.0%	0.0%	551	0.0%	0.0%	265
Other Ferrous	0.6%	0.2%	64,983	0.6%	0.2%	41,195
Aluminum Cans - CRV	0.1%	0.0%	11,982	0.1%	0.0%	8,322
Aluminum Cans - Non-CRV	0.1%	0.0%	8,659	0.1%	0.0%	5,882
Other Non-Ferrous	0.4%	0.1%	38,313	0.3%	0.1%	22,966
Remainder/Composite Metal	0.5%	0.2%	51,375	0.5%	0.2%	33,811
Electronics	1.0%		111,965	1.1%		70,443
Brown Goods	0.2%	0.4%	25,046	0.2%	0.2%	10,900
Computer-related Electronics	0.2%	0.1%	18,192	0.2%	0.2%	11,696
Other Small Consumer Electronics	0.4%	0.2%	46,572	0.5%	0.2%	30,125
Video Display Devices - CRT	0.1%	0.2%	13,823	0.2%	0.3%	14,267
Video Display Devices - Other	0.1%	0.1%	8,332	0.1%	0.1%	3,455
Plastic	10.0%		1,088,970	10.4%		694,687
PETE Containers - CRV	0.3%	0.1%	31,732	0.3%	0.1%	19,911
PETE Containers - Non-CRV	0.4%	0.1%	44,127	0.4%	0.1%	28,066
HDPE Containers - CRV	0.0%	0.0%	2,206	0.0%	0.0%	1,688
HDPE Containers - Non-CRV	0.5%	0.1%	51,971	0.5%	0.1%	33,757
Miscellaneous Plastic Containers - CRV	0.0%	0.1%	4,412	0.0%	0.0%	2,091
Miscellaneous Plastic Containers - Non-CRV	0.6%	0.2%	64,603	0.7%	0.2%	43,730
Plastic Trash Bags	1.2%	0.1%	130,853	1.3%	0.1%	87,456
Plastic Grocery and Other Merchandise Bags	0.8%	0.1%	83,057	0.8%	0.1%	53,257
Non-Bag Commercial and Industrial Packaging Film	0.1%	0.0%	12,857	0.1%	0.0%	9,021
Film Products	0.0%	0.1%	4,991	0.1%	0.1%	4,342
Other Film - Flexible Plastic Pouches	0.2%	0.0%	18,818	0.2%	0.0%	11,562
Other Film - Other	1.7%	0.2%	187,009	1.9%	0.2%	127,690
Durable Plastic Items - #2 and #5 Bulky Rigid	0.6%	0.3%	60,099	0.6%	0.3%	41,035
Durable Plastic Items - Other	1.4%	0.6%	155,683	1.2%	0.4%	81,898
Remainder/Composite Plastic	2.2%	0.3%	236,553	2.2%	0.2%	149,186

Confidence intervals calculated at the 90% confidence level. Percentages for material types may not total 100% due to rounding.

Table 52 (continued): Composition of Single-Family Residential Disposed Waste Using Expanded Material Types

Material	Est. Using 2014 Sector Percentages			Est. Using 2008 Sector Percentages		
	Estimated Percent	+ / -	Estimated Tons	Estimated Percent	+ / -	Estimated Tons
Other Organic	45.7%		4,996,637	46.1%		3,067,981
Food	21.0%	2.0%	2,293,394	22.8%	1.8%	1,519,577
Leaves and Grass	5.1%	2.1%	561,346	4.1%	1.5%	271,221
Prunings and Trimmings	4.8%	2.1%	523,588	3.7%	1.4%	245,332
Branches and Stumps	1.9%	1.7%	211,735	1.4%	1.1%	96,134
Manures	0.0%	0.0%	3,164	0.0%	0.0%	3,224
Textiles	4.8%	0.7%	522,698	5.2%	0.7%	345,065
Carpet	1.8%	1.0%	195,583	1.7%	0.9%	115,873
Remainder/Composite Organic	6.3%	0.8%	685,129	7.1%	0.8%	471,555
Inerts and Other	12.3%		1,343,324	10.5%		700,194
Concrete	0.9%	0.6%	100,747	0.8%	0.4%	53,079
Asphalt Paving	0.0%	0.0%	0	0.0%	0.0%	0
Asphalt Roofing	0.6%	0.7%	65,708	0.4%	0.5%	29,727
Clean Dimensional Lumber	1.9%	1.8%	207,773	1.4%	1.2%	95,045
Clean Engineered Wood	1.1%	1.1%	122,351	0.8%	0.7%	54,854
Clean Pallets & Crates	0.3%	0.3%	30,327	0.2%	0.2%	14,353
Other Wood Waste	4.0%	2.3%	441,869	3.8%	1.7%	252,121
Gypsum Board	0.2%	0.2%	26,044	0.2%	0.1%	16,262
Rock, Soil and Fines	2.3%	0.9%	246,993	1.9%	0.6%	124,576
Remainder/Composite Inerts and Other	0.9%	0.5%	101,512	0.9%	0.4%	60,177
Household Hazardous Waste (HHW)	0.6%		63,355	0.5%		34,554
Paint	0.2%	0.3%	25,861	0.2%	0.2%	10,677
Vehicle and Equipment Fluids	0.0%	0.0%	219	0.0%	0.0%	88
Used Oil	0.0%	0.0%	711	0.0%	0.0%	287
Batteries	0.1%	0.0%	7,317	0.1%	0.0%	5,988
Mercury-Containing Items - Not Lamps	0.0%	0.0%	0	0.0%	0.0%	0
Lamps - Fluorescent and LED	0.1%	0.1%	6,896	0.1%	0.1%	5,372
Remainder/Composite Household Hazardous	0.2%	0.1%	22,352	0.2%	0.1%	12,141
Special Waste	2.9%		318,424	2.8%		186,387
Ash	0.0%	0.0%	1,502	0.0%	0.0%	788
Treated Medical Waste	0.0%	0.0%	0	0.0%	0.0%	0
Bulky Items	2.7%	2.3%	294,460	2.5%	1.8%	166,726
Tires	0.1%	0.2%	11,368	0.1%	0.2%	9,533
Remainder/Composite Special Waste	0.1%	0.1%	11,094	0.1%	0.1%	9,341
Mixed Residue	5.1%		562,072	5.6%		375,541
Totals	100.0%		10,924,313	100.0%		6,662,188
Sample Count	201			201		

Confidence intervals calculated at the 90% confidence level. Percentages for material types may not total 100% due to rounding.

The above table presents the 2014 sector percentages applied to the 2014 waste composition data and, for comparison, the sector percentages obtained in the 2008 Statewide Waste Characterization Study applied to the 2014 waste composition data. See *Special Note Regarding Sector Percentages* on Page 3 for a further explanation of the sector percentage issues.

Multi-Family Residential Waste

Table 53: Ten Most Prevalent Material Types in Multi-Family Residential Disposed Waste Using Expanded Material Types

Material	Estimated Percent	Cumulative Percent	Estimated Tons
Food	24.7%	24.7%	888,327
Textiles	7.6%	32.3%	273,436
Remainder/Composite Organic	7.1%	39.4%	255,169
Remainder/Composite Paper - Compostable	6.8%	46.3%	244,455
Newspaper	5.0%	51.2%	179,291
Other Miscellaneous Paper - Other	4.8%	56.0%	172,394
Uncoated Corrugated Cardboard	3.6%	59.6%	129,166
Mixed Residue	3.6%	63.2%	128,869
Remainder/Composite Plastic	3.5%	66.7%	124,486
Bulky Items	2.9%	69.6%	105,915
Total	69.6%		2,501,510

Any differences between *cumulative percent* figures and the sum of *estimated percent* figures are due to rounding. The above table was constructed using sector percentage data obtained from the 2014 vehicle surveys applied to 2014 composition results. See *Special Note Regarding Sector Percentages* on Page 3 for a further explanation of the sector percentage issues.

Table 54: Composition of Multi-Family Residential Disposed Waste Using Expanded Material Types

Material	Est. Using 2014 Sector Percentages			Est. Using 2008 Sector Percentages		
	Estimated Percent	+ / -	Estimated Tons	Estimated Percent	+ / -	Estimated Tons
Paper	23.9%		858,806	24.3%		629,829
Uncoated Corrugated Cardboard	3.6%	2.8%	129,166	3.6%	2.9%	92,209
Paper Bags	0.6%	0.4%	20,110	0.6%	0.4%	14,957
Newspaper	5.0%	5.1%	179,291	5.2%	5.4%	135,144
White Ledger Paper	0.5%	0.5%	18,173	0.5%	0.5%	13,735
Other Office Paper	0.5%	0.4%	19,476	0.5%	0.4%	14,066
Magazines and Catalogs	0.7%	0.3%	26,742	0.8%	0.3%	19,791
Phone Books and Directories	0.0%	0.0%	864	0.0%	0.0%	519
Other Miscellaneous Paper - Compostable	0.3%	0.2%	9,638	0.2%	0.2%	6,074
Other Miscellaneous Paper - Other	4.8%	3.1%	172,394	4.9%	3.3%	126,103
Remainder/Composite Paper - Rigid Food & Beverage Cartons	0.3%	0.2%	11,403	0.3%	0.2%	8,602
Remainder/Composite Paper - Compostable	6.8%	4.1%	244,455	6.9%	4.4%	178,334
Remainder/Composite Paper - Other	0.8%	0.7%	27,095	0.8%	0.8%	20,296
Glass	3.0%		108,394	3.0%		77,859
Clear Glass Bottles and Containers - CRV	0.8%	0.3%	29,609	0.8%	0.3%	21,577
Clear Glass Bottles and Containers - Non-CRV	0.8%	0.4%	28,783	0.8%	0.4%	20,844
Green Glass Bottles and Containers - CRV	0.1%	0.0%	2,173	0.1%	0.0%	1,627
Green Glass Bottles and Containers - Non-CRV	0.1%	0.1%	2,457	0.1%	0.1%	1,731
Brown Glass Bottles and Containers - CRV	0.6%	0.4%	20,632	0.6%	0.5%	15,411
Brown Glass Bottles and Containers - Non-CRV	0.1%	0.1%	3,995	0.1%	0.1%	2,894
Other Colored Glass Bottles and Containers - CRV	0.1%	0.1%	2,356	0.1%	0.1%	1,817
Other Colored Glass Bottles and Containers - Non-CRV	0.0%	0.0%	106	0.0%	0.0%	78
Flat Glass	0.0%	0.1%	1,510	0.0%	0.1%	1,229
Remainder/Composite Glass	0.5%	0.3%	16,772	0.4%	0.3%	10,651
Metal	3.3%		117,094	2.9%		75,273
Tin/Steel Cans - CRV Bimetal Containers	0.2%	0.3%	8,839	0.3%	0.4%	6,818
Tin/Steel Cans - Other	0.7%	0.4%	24,703	0.7%	0.4%	17,491
Major Appliances	0.0%	0.0%	3	0.0%	0.0%	1
Used Oil Filters	0.0%	0.0%	0	0.0%	0.0%	0
Other Ferrous	0.7%	0.5%	24,133	0.5%	0.4%	12,908
Aluminum Cans - CRV	0.1%	0.1%	4,122	0.1%	0.1%	2,923
Aluminum Cans - Non-CRV	0.1%	0.1%	4,245	0.1%	0.2%	3,199
Other Non-Ferrous	0.7%	0.6%	26,691	0.6%	0.5%	16,406
Remainder/Composite Metal	0.7%	0.2%	24,358	0.6%	0.2%	15,527
Electronics	1.4%		48,820	1.3%		34,363
Brown Goods	0.5%	0.6%	16,310	0.5%	0.6%	12,150
Computer-related Electronics	0.2%	0.2%	6,708	0.2%	0.2%	5,350
Other Small Consumer Electronics	0.2%	0.2%	8,508	0.3%	0.2%	6,714
Video Display Devices - CRT	0.3%	0.5%	10,456	0.2%	0.3%	4,888
Video Display Devices - Other	0.2%	0.3%	6,837	0.2%	0.3%	5,260
Plastic	11.0%		396,077	11.1%		287,902
PETE Containers - CRV	0.4%	0.3%	13,983	0.4%	0.3%	10,163
PETE Containers - Non-CRV	0.6%	0.4%	20,643	0.6%	0.4%	15,259
HDPE Containers - CRV	0.0%	0.0%	1,275	0.0%	0.0%	909
HDPE Containers - Non-CRV	0.4%	0.2%	14,550	0.4%	0.2%	10,201
Miscellaneous Plastic Containers - CRV	0.1%	0.1%	2,082	0.1%	0.1%	1,614
Miscellaneous Plastic Containers - Non-CRV	0.6%	0.4%	21,150	0.6%	0.5%	15,585
Plastic Trash Bags	1.1%	0.3%	40,025	1.1%	0.3%	28,943
Plastic Grocery and Other Merchandise Bags	0.9%	0.3%	32,296	0.9%	0.3%	23,776
Non-Bag Commercial and Industrial Packaging Film	0.2%	0.3%	6,791	0.2%	0.3%	5,222
Film Products	0.0%	0.0%	65	0.0%	0.0%	50
Other Film - Flexible Plastic Pouches	0.4%	0.6%	16,099	0.5%	0.6%	12,137
Other Film - Other	1.8%	0.5%	63,826	1.8%	0.6%	46,955
Durable Plastic Items - #2 and #5 Bulky Rigid	0.1%	0.1%	5,076	0.2%	0.1%	4,063
Durable Plastic Items - Other	0.9%	0.5%	33,730	0.8%	0.5%	21,921
Remainder/Composite Plastic	3.5%	1.0%	124,486	3.5%	1.1%	91,106

Confidence intervals calculated at the 90% confidence level. Percentages for material types may not total 100% due to rounding.

Table 54 (continued): Composition of Multi-Family Residential Disposed Waste Using Expanded Material Types

Material	Est. Using 2014 Sector Percentages			Est. Using 2008 Sector Percentages		
	Estimated Percent	+ / -	Estimated Tons	Estimated Percent	+ / -	Estimated Tons
Other Organic	43.8%		1,571,832	43.5%		1,127,595
Food	24.7%	3.6%	888,327	24.8%	3.8%	642,265
Leaves and Grass	2.8%	2.1%	102,311	2.8%	2.2%	71,886
Prunings and Trimmings	0.8%	0.8%	29,495	0.8%	0.8%	20,101
Branches and Stumps	0.0%	0.0%	0	0.0%	0.0%	0
Manures	0.0%	0.0%	0	0.0%	0.0%	0
Textiles	7.6%	4.0%	273,436	7.8%	4.2%	201,973
Carpet	0.6%	0.7%	23,094	0.7%	0.7%	17,642
Remainder/Composite Organic	7.1%	2.1%	255,169	6.7%	2.2%	173,727
Inerts and Other	6.1%		220,287	6.2%		159,521
Concrete	0.3%	0.4%	10,237	0.3%	0.4%	7,615
Asphalt Paving	0.0%	0.0%	0	0.0%	0.0%	0
Asphalt Roofing	0.0%	0.0%	0	0.0%	0.0%	0
Clean Dimensional Lumber	0.5%	0.5%	19,227	0.4%	0.5%	11,655
Clean Engineered Wood	0.1%	0.1%	4,143	0.1%	0.1%	2,471
Clean Pallets & Crates	2.3%	2.5%	80,853	2.4%	2.7%	61,704
Other Wood Waste	2.1%	2.1%	73,933	2.1%	2.2%	53,513
Gypsum Board	0.4%	0.4%	14,751	0.4%	0.4%	10,499
Rock, Soil and Fines	0.3%	0.2%	9,409	0.3%	0.2%	6,498
Remainder/Composite Inerts and Other	0.2%	0.2%	7,734	0.2%	0.2%	5,567
Household Hazardous Waste (HHW)	0.1%		2,814	0.1%		2,042
Paint	0.0%	0.0%	24	0.0%	0.0%	9
Vehicle and Equipment Fluids	0.0%	0.0%	0	0.0%	0.0%	0
Used Oil	0.0%	0.0%	0	0.0%	0.0%	0
Batteries	0.0%	0.0%	1,183	0.0%	0.0%	839
Mercury-Containing Items - Not Lamps	0.0%	0.0%	8	0.0%	0.0%	7
Lamps - Fluorescent and LED	0.0%	0.0%	81	0.0%	0.0%	63
Remainder/Composite Household Hazardous	0.0%	0.0%	1,518	0.0%	0.0%	1,123
Special Waste	3.9%		138,906	3.9%		101,750
Ash	0.1%	0.1%	2,442	0.1%	0.1%	2,050
Treated Medical Waste	0.8%	1.3%	29,791	0.9%	1.4%	22,977
Bulky Items	2.9%	3.1%	105,915	2.9%	3.3%	76,181
Tires	0.0%	0.0%	0	0.0%	0.0%	0
Remainder/Composite Special Waste	0.0%	0.0%	758	0.0%	0.0%	542
Mixed Residue	3.6%		128,869	3.7%		95,681
Totals	100.0%		3,591,900	100.0%		2,591,814
Sample Count	52			52		

Confidence intervals calculated at the 90% confidence level. Percentages for material types may not total 100% due to rounding.

The above table presents the 2014 sector percentages applied to the 2014 waste composition data and, for comparison, the sector percentages obtained in the 2008 Statewide Waste Characterization Study applied to the 2014 waste composition data. See *Special Note Regarding Sector Percentages* on Page 3 for a further explanation of the sector percentage issues.

Self-Hauled Waste

Table 55: Ten Most Prevalent Material Types in Overall Self-Hauled Disposed Waste Using Expanded Material Types

Material	Estimated Percent	Cumulative Percent	Estimated Tons
Other Wood Waste	14.7%	14.7%	654,474
Bulky Items	11.4%	26.2%	507,514
Remainder/Composite Inerts and Other	9.2%	35.4%	409,945
Rock, Soil and Fines	5.9%	41.4%	263,447
Clean Dimensional Lumber	5.5%	46.9%	245,323
Carpet	5.3%	52.2%	235,989
Prunings and Trimmings	4.5%	56.7%	197,929
Gypsum Board	4.3%	61.0%	192,185
Clean Engineered Wood	4.1%	65.1%	183,482
Clean Pallets & Crates	3.9%	69.0%	173,123
Total	69.0%		3,063,412

Any differences between *cumulative percent* figures and the sum of *estimated percent* figures are due to rounding. The above table was constructed using sector percentage data obtained from the 2014 vehicle surveys applied to 2014 composition results. See *Special Note Regarding Sector Percentages* on Page 3 for a further explanation of the sector percentage issues.

Table 56: Composition of Overall Self-Hauled Disposed Waste Using Expanded Material Types

Material	Est. Using 2014 Sector Percentages			Est. Using 2008 Sector Percentages		
	Estimated Percent	+ / -	Estimated Tons	Estimated Percent	+ / -	Estimated Tons
Paper	3.3%		146,520	3.3%		206,490
Uncoated Corrugated Cardboard	1.9%	1.0%	84,253	2.0%	1.3%	124,666
Paper Bags	0.1%	0.2%	5,683	0.1%	0.1%	5,972
Newspaper	0.0%	0.0%	1,587	0.0%	0.0%	2,261
White Ledger Paper	0.0%	0.0%	1,973	0.0%	0.0%	2,074
Other Office Paper	0.0%	0.0%	1,222	0.0%	0.0%	1,253
Magazines and Catalogs	0.1%	0.1%	4,497	0.1%	0.1%	4,880
Phone Books and Directories	0.1%	0.1%	2,845	0.1%	0.1%	3,696
Other Miscellaneous Paper - Compostable	0.0%	0.0%	203	0.0%	0.0%	251
Other Miscellaneous Paper - Other	0.6%	0.4%	24,718	0.6%	0.5%	36,341
Remainder/Composite Paper - Rigid Food & Beverage Cartons	0.0%	0.0%	299	0.0%	0.0%	374
Remainder/Composite Paper - Compostable	0.2%	0.1%	7,934	0.2%	0.1%	11,099
Remainder/Composite Paper - Other	0.3%	0.2%	11,306	0.2%	0.2%	13,624
Glass	1.1%		46,686	0.8%		53,618
Clear Glass Bottles and Containers - CRV	0.1%	0.0%	2,825	0.1%	0.0%	3,208
Clear Glass Bottles and Containers - Non-CRV	0.0%	0.0%	1,916	0.0%	0.0%	2,394
Green Glass Bottles and Containers - CRV	0.0%	0.0%	507	0.0%	0.0%	602
Green Glass Bottles and Containers - Non-CRV	0.0%	0.0%	148	0.0%	0.0%	167
Brown Glass Bottles and Containers - CRV	0.1%	0.1%	2,534	0.0%	0.0%	2,761
Brown Glass Bottles and Containers - Non-CRV	0.0%	0.0%	122	0.0%	0.0%	140
Other Colored Glass Bottles and Containers - CRV	0.0%	0.0%	12	0.0%	0.0%	18
Other Colored Glass Bottles and Containers - Non-CRV	0.0%	0.0%	45	0.0%	0.0%	43
Flat Glass	0.5%	0.3%	22,303	0.4%	0.2%	23,928
Remainder/Composite Glass	0.4%	0.2%	16,275	0.3%	0.2%	20,357
Metal	3.4%		152,581	3.1%		196,284
Tin/Steel Cans - CRV Bimetal Containers	0.0%	0.0%	81	0.0%	0.0%	162
Tin/Steel Cans - Other	0.2%	0.2%	9,792	0.2%	0.2%	10,243
Major Appliances	0.1%	0.1%	4,175	0.1%	0.1%	5,126
Used Oil Filters	0.0%	0.0%	133	0.0%	0.0%	303
Other Ferrous	1.0%	0.4%	43,427	0.9%	0.4%	54,371
Aluminum Cans - CRV	0.0%	0.0%	342	0.0%	0.0%	438
Aluminum Cans - Non-CRV	0.0%	0.0%	33	0.0%	0.0%	46
Other Non-Ferrous	0.5%	0.4%	21,643	0.6%	0.5%	34,951
Remainder/Composite Metal	1.6%	0.7%	72,955	1.4%	0.6%	90,642
Electronics	0.5%		22,981	0.4%		27,275
Brown Goods	0.1%	0.1%	3,588	0.1%	0.1%	3,777
Computer-related Electronics	0.2%	0.2%	8,444	0.1%	0.2%	8,548
Other Small Consumer Electronics	0.1%	0.1%	5,854	0.1%	0.2%	8,938
Video Display Devices - CRT	0.1%	0.2%	4,428	0.1%	0.1%	4,496
Video Display Devices - Other	0.0%	0.0%	667	0.0%	0.0%	1,515
Plastic	5.4%		239,437	4.9%		309,812
PETE Containers - CRV	0.0%	0.0%	1,209	0.0%	0.0%	1,513
PETE Containers - Non-CRV	0.1%	0.1%	3,143	0.1%	0.1%	3,314
HDPE Containers - CRV	0.0%	0.0%	170	0.0%	0.0%	229
HDPE Containers - Non-CRV	0.0%	0.0%	666	0.0%	0.0%	861
Miscellaneous Plastic Containers - CRV	0.0%	0.0%	2	0.0%	0.0%	2
Miscellaneous Plastic Containers - Non-CRV	0.0%	0.0%	825	0.0%	0.0%	946
Plastic Trash Bags	0.1%	0.0%	3,851	0.1%	0.1%	5,565
Plastic Grocery and Other Merchandise Bags	0.0%	0.0%	842	0.0%	0.0%	953
Non-Bag Commercial and Industrial Packaging Film	0.1%	0.1%	3,395	0.1%	0.1%	3,687
Film Products	0.2%	0.3%	8,346	0.2%	0.4%	14,720
Other Film - Flexible Plastic Pouches	0.0%	0.0%	132	0.0%	0.0%	174
Other Film - Other	0.1%	0.1%	6,024	0.1%	0.1%	7,877
Durable Plastic Items - #2 and #5 Bulky Rigid	0.3%	0.2%	12,269	0.2%	0.1%	12,813
Durable Plastic Items - Other	2.0%	1.2%	88,457	1.7%	0.9%	107,393
Remainder/Composite Plastic	2.5%	1.5%	110,105	2.4%	1.6%	149,764

Confidence intervals calculated at the 90% confidence level. Percentages for material types may not total 100% due to rounding.

Table 56 (continued): Composition of Overall Self-Hauled Disposed Waste Using Expanded Material Types

Material	Est. Using 2014 Sector Percentages			Est. Using 2008 Sector Percentages		
	Estimated Percent	+ / -	Estimated Tons	Estimated Percent	+ / -	Estimated Tons
Other Organic	19.0%		843,874	20.4%		1,289,332
Food	0.4%	0.3%	18,535	0.4%	0.2%	23,092
Leaves and Grass	3.0%	2.5%	131,527	3.4%	3.2%	211,664
Prunings and Trimmings	4.5%	2.9%	197,929	5.3%	3.8%	336,242
Branches and Stumps	2.4%	1.8%	108,345	2.8%	2.3%	177,973
Manures	0.5%	0.6%	21,189	0.3%	0.4%	21,230
Textiles	1.6%	0.5%	72,748	1.5%	0.5%	96,290
Carpet	5.3%	2.4%	235,989	5.2%	2.8%	327,354
Remainder/Composite Organic	1.3%	1.0%	57,612	1.5%	1.3%	95,487
Inerts and Other	54.9%		2,436,390	55.3%		3,488,473
Concrete	3.9%	1.9%	171,032	3.8%	2.1%	237,906
Asphalt Paving	1.5%	2.4%	65,490	2.0%	3.2%	123,205
Asphalt Roofing	1.8%	1.3%	77,888	1.5%	1.0%	93,999
Clean Dimensional Lumber	5.5%	2.1%	245,323	5.1%	2.3%	322,772
Clean Engineered Wood	4.1%	2.0%	183,482	4.0%	2.5%	249,734
Clean Pallets & Crates	3.9%	2.4%	173,123	4.3%	2.9%	268,316
Other Wood Waste	14.7%	2.9%	654,474	13.8%	3.1%	868,368
Gypsum Board	4.3%	2.2%	192,185	4.2%	2.4%	265,032
Rock, Soil and Fines	5.9%	3.0%	263,447	6.8%	3.7%	430,638
Remainder/Composite Inerts and Other	9.2%	3.7%	409,945	10.0%	4.6%	628,504
Household Hazardous Waste (HHW)	0.0%		1,684	0.0%		1,980
Paint	0.0%	0.0%	79	0.0%	0.0%	81
Vehicle and Equipment Fluids	0.0%	0.0%	0	0.0%	0.0%	0
Used Oil	0.0%	0.0%	38	0.0%	0.0%	87
Batteries	0.0%	0.0%	257	0.0%	0.0%	345
Mercury-Containing Items - Not Lamps	0.0%	0.0%	0	0.0%	0.0%	0
Lamps - Fluorescent and LED	0.0%	0.0%	46	0.0%	0.0%	52
Remainder/Composite Household Hazardous	0.0%	0.0%	1,263	0.0%	0.0%	1,416
Special Waste	12.0%		532,145	11.4%		718,568
Ash	0.0%	0.0%	787	0.0%	0.0%	817
Treated Medical Waste	0.0%	0.0%	0	0.0%	0.0%	0
Bulky Items	11.4%	3.6%	507,514	11.0%	4.2%	693,930
Tires	0.5%	0.8%	23,787	0.4%	0.6%	23,749
Remainder/Composite Special Waste	0.0%	0.0%	57	0.0%	0.0%	72
Mixed Residue	0.4%		15,832	0.3%		16,953
Totals	100.0%		4,438,130	100.0%		6,308,785
Sample Count	250			250		

Confidence intervals calculated at the 90% confidence level. Percentages for material types may not total 100% due to rounding.

The above table presents the 2014 sector percentages applied to the 2014 waste composition data and, for comparison, the sector percentages obtained in the 2008 Statewide Waste Characterization Study applied to the 2014 waste composition data. See *Special Note Regarding Sector Percentages* on Page 3 for a further explanation of the sector percentage issues.

Commercial Self-Hauled Waste

Table 57: Ten Most Prevalent Material Types in Commercial Self-Hauled Disposed Waste Using Expanded Material Types

Material	Estimated Percent	Cumulative Percent	Estimated Tons
Other Wood Waste	14.3%	14.3%	498,907
Remainder/Composite Inerts and Other	10.5%	24.8%	365,796
Bulky Items	9.9%	34.7%	344,809
Rock, Soil and Fines	6.9%	41.6%	241,201
Carpet	5.7%	47.3%	199,030
Prunings and Trimmings	5.1%	52.4%	178,039
Clean Dimensional Lumber	4.9%	57.3%	170,325
Gypsum Board	4.3%	61.6%	148,294
Clean Pallets & Crates	4.1%	65.7%	144,155
Concrete	3.8%	69.5%	133,417
Total	69.5%		2,423,973

Any differences between *cumulative percent* figures and the sum of *estimated percent* figures are due to rounding. The above table was constructed using sector percentage data obtained from the 2014 vehicle surveys applied to 2014 composition results. See *Special Note Regarding Sector Percentages* on Page 3 for a further explanation of the sector percentage issues.

Table 58: Composition of Commercial Self-Hauled Disposed Waste Using Expanded Material Types

Material	Est. Using 2014 Sector Percentages			Est. Using 2008 Sector Percentages		
	Estimated Percent	+ / -	Estimated Tons	Estimated Percent	+ / -	Estimated Tons
Paper	3.5%		120,401	3.3%		174,936
Uncoated Corrugated Cardboard	2.0%	1.3%	71,444	2.1%	1.5%	110,420
Paper Bags	0.2%	0.3%	5,536	0.1%	0.2%	5,712
Newspaper	0.0%	0.0%	1,055	0.0%	0.0%	1,363
White Ledger Paper	0.0%	0.1%	1,718	0.0%	0.0%	1,752
Other Office Paper	0.0%	0.0%	1,203	0.0%	0.0%	1,226
Magazines and Catalogs	0.1%	0.1%	2,832	0.1%	0.1%	2,901
Phone Books and Directories	0.1%	0.1%	2,517	0.1%	0.1%	3,362
Other Miscellaneous Paper - Compostable	0.0%	0.0%	61	0.0%	0.0%	80
Other Miscellaneous Paper - Other	0.6%	0.5%	19,787	0.6%	0.6%	30,512
Remainder/Composite Paper - Rigid Food & Beverage Cartons	0.0%	0.0%	161	0.0%	0.0%	170
Remainder/Composite Paper - Compostable	0.1%	0.1%	4,588	0.1%	0.1%	6,271
Remainder/Composite Paper - Other	0.3%	0.2%	9,500	0.2%	0.2%	11,167
Glass	0.6%		22,123	0.5%		26,188
Clear Glass Bottles and Containers - CRV	0.1%	0.1%	2,350	0.0%	0.0%	2,505
Clear Glass Bottles and Containers - Non-CRV	0.0%	0.0%	377	0.0%	0.0%	466
Green Glass Bottles and Containers - CRV	0.0%	0.0%	422	0.0%	0.0%	429
Green Glass Bottles and Containers - Non-CRV	0.0%	0.0%	17	0.0%	0.0%	22
Brown Glass Bottles and Containers - CRV	0.1%	0.1%	1,933	0.0%	0.1%	1,946
Brown Glass Bottles and Containers - Non-CRV	0.0%	0.0%	93	0.0%	0.0%	99
Other Colored Glass Bottles and Containers - CRV	0.0%	0.0%	9	0.0%	0.0%	14
Other Colored Glass Bottles and Containers - Non-CRV	0.0%	0.0%	0	0.0%	0.0%	0
Flat Glass	0.3%	0.2%	8,943	0.2%	0.2%	9,036
Remainder/Composite Glass	0.2%	0.2%	7,978	0.2%	0.2%	11,670
Metal	3.2%		111,828	2.8%		149,072
Tin/Steel Cans - CRV Bimetal Containers	0.0%	0.0%	60	0.0%	0.0%	112
Tin/Steel Cans - Other	0.1%	0.1%	2,386	0.0%	0.1%	2,498
Major Appliances	0.1%	0.1%	1,750	0.1%	0.1%	2,677
Used Oil Filters	0.0%	0.0%	0	0.0%	0.0%	0
Other Ferrous	0.8%	0.4%	28,619	0.7%	0.4%	37,649
Aluminum Cans - CRV	0.0%	0.0%	165	0.0%	0.0%	171
Aluminum Cans - Non-CRV	0.0%	0.0%	15	0.0%	0.0%	17
Other Non-Ferrous	0.6%	0.5%	21,093	0.6%	0.6%	34,176
Remainder/Composite Metal	1.7%	0.8%	57,741	1.4%	0.7%	71,773
Electronics	0.4%		13,474	0.3%		16,634
Brown Goods	0.0%	0.0%	442	0.0%	0.0%	443
Computer-related Electronics	0.2%	0.3%	8,390	0.2%	0.2%	8,463
Other Small Consumer Electronics	0.1%	0.2%	4,642	0.1%	0.2%	7,728
Video Display Devices - CRT	0.0%	0.0%	0	0.0%	0.0%	0
Video Display Devices - Other	0.0%	0.0%	0	0.0%	0.0%	0
Plastic	5.5%		192,490	4.9%		257,242
PETE Containers - CRV	0.0%	0.0%	590	0.0%	0.0%	604
PETE Containers - Non-CRV	0.1%	0.1%	2,661	0.1%	0.1%	2,688
HDPE Containers - CRV	0.0%	0.0%	69	0.0%	0.0%	71
HDPE Containers - Non-CRV	0.0%	0.0%	249	0.0%	0.0%	271
Miscellaneous Plastic Containers - CRV	0.0%	0.0%	2	0.0%	0.0%	2
Miscellaneous Plastic Containers - Non-CRV	0.0%	0.0%	392	0.0%	0.0%	407
Plastic Trash Bags	0.1%	0.1%	2,815	0.1%	0.1%	3,963
Plastic Grocery and Other Merchandise Bags	0.0%	0.0%	427	0.0%	0.0%	462
Non-Bag Commercial and Industrial Packaging Film	0.1%	0.1%	3,075	0.1%	0.1%	3,111
Film Products	0.2%	0.3%	7,227	0.3%	0.4%	13,595
Other Film - Flexible Plastic Pouches	0.0%	0.0%	54	0.0%	0.0%	62
Other Film - Other	0.1%	0.1%	3,795	0.1%	0.1%	4,772
Durable Plastic Items - #2 and #5 Bulky Rigid	0.1%	0.1%	4,486	0.1%	0.1%	4,674
Durable Plastic Items - Other	2.1%	1.5%	74,787	1.7%	1.1%	92,363
Remainder/Composite Plastic	2.6%	1.9%	91,864	2.5%	1.9%	130,195

Confidence intervals calculated at the 90% confidence level. Percentages for material types may not total 100% due to rounding.

Table 58 (continued): Composition of Commercial Self-Hauled Disposed Waste Using Expanded Material Types

Material	Est. Using 2014 Sector Percentages			Est. Using 2008 Sector Percentages		
	Estimated Percent	+ / -	Estimated Tons	Estimated Percent	+ / -	Estimated Tons
Other Organic	19.7%		686,684	21.1%		1,113,522
Food	0.3%	0.3%	11,848	0.2%	0.2%	13,044
Leaves and Grass	3.0%	3.1%	105,942	3.5%	3.8%	182,396
Prunings and Trimmings	5.1%	3.6%	178,039	6.0%	4.5%	314,718
Branches and Stumps	2.5%	2.2%	86,838	2.9%	2.7%	154,702
Manures	0.2%	0.3%	6,830	0.1%	0.2%	6,806
Textiles	1.4%	0.6%	50,192	1.3%	0.6%	70,310
Carpet	5.7%	2.9%	199,030	5.5%	3.3%	288,908
Remainder/Composite Organic	1.4%	1.2%	47,965	1.6%	1.5%	82,638
Inerts and Other	56.4%		1,967,258	56.7%		2,995,314
Concrete	3.8%	2.2%	133,417	3.8%	2.4%	198,665
Asphalt Paving	1.9%	3.1%	65,490	2.3%	3.8%	123,205
Asphalt Roofing	2.2%	1.6%	74,990	1.7%	1.2%	89,766
Clean Dimensional Lumber	4.9%	2.4%	170,325	4.6%	2.7%	243,919
Clean Engineered Wood	3.6%	2.5%	124,683	3.6%	2.9%	188,173
Clean Pallets & Crates	4.1%	2.8%	144,155	4.5%	3.4%	238,768
Other Wood Waste	14.3%	3.4%	498,907	13.3%	3.5%	703,899
Gypsum Board	4.3%	2.5%	148,294	4.2%	2.8%	219,533
Rock, Soil and Fines	6.9%	3.8%	241,201	7.7%	4.4%	405,813
Remainder/Composite Inerts and Other	10.5%	4.6%	365,796	11.0%	5.4%	583,573
Household Hazardous Waste (HHW)	0.0%		839	0.0%		891
Paint	0.0%	0.0%	75	0.0%	0.0%	74
Vehicle and Equipment Fluids	0.0%	0.0%	0	0.0%	0.0%	0
Used Oil	0.0%	0.0%	0	0.0%	0.0%	0
Batteries	0.0%	0.0%	146	0.0%	0.0%	186
Mercury-Containing Items - Not Lamps	0.0%	0.0%	0	0.0%	0.0%	0
Lamps - Fluorescent and LED	0.0%	0.0%	9	0.0%	0.0%	9
Remainder/Composite Household Hazardous	0.0%	0.0%	609	0.0%	0.0%	621
Special Waste	10.5%		366,214	10.3%		546,786
Ash	0.0%	0.0%	0	0.0%	0.0%	0
Treated Medical Waste	0.0%	0.0%	0	0.0%	0.0%	0
Bulky Items	9.9%	4.3%	344,809	9.9%	4.9%	525,447
Tires	0.6%	1.0%	21,363	0.4%	0.7%	21,286
Remainder/Composite Special Waste	0.0%	0.0%	42	0.0%	0.0%	53
Mixed Residue	0.1%		4,984	0.1%		5,162
Totals	100.0%		3,486,297	100.0%		5,285,747
Sample Count	134			134		

Confidence intervals calculated at the 90% confidence level. Percentages for material types may not total 100% due to rounding.

The above table presents the 2014 sector percentages applied to the 2014 waste composition data and, for comparison, the sector percentages obtained in the 2008 Statewide Waste Characterization Study applied to the 2014 waste composition data. See *Special Note Regarding Sector Percentages* on Page 3 for a further explanation of the sector percentage issues.

Residential Self-Hauled Waste

Table 59: Ten Most Prevalent Material Types in Residential Self-Hauled Disposed Waste Using Expanded Material Types

Material	Estimated Percent	Cumulative Percent	Estimated Tons
Bulky Items	17.1%	17.1%	162,704
Other Wood Waste	16.3%	33.4%	155,567
Clean Dimensional Lumber	7.9%	41.3%	74,999
Clean Engineered Wood	6.2%	47.5%	58,799
Remainder/Composite Inerts and Other	4.6%	52.1%	44,149
Gypsum Board	4.6%	56.7%	43,892
Concrete	4.0%	60.7%	37,614
Carpet	3.9%	64.6%	36,959
Clean Pallets & Crates	3.0%	67.6%	28,967
Leaves and Grass	2.7%	70.3%	25,584
Total	70.3%		669,235

Any differences between *cumulative percent* figures and the sum of *estimated percent* figures are due to rounding. The above table was constructed using sector percentage data obtained from the 2014 vehicle surveys applied to 2014 composition results. See *Special Note Regarding Sector Percentages* on Page 3 for a further explanation of the sector percentage issues.

Table 60: Composition of Residential Self-Hauled Disposed Waste Using Expanded Material Types

Material	Est. Using 2014 Sector Percentages			Est. Using 2008 Sector Percentages		
	Estimated Percent	+ / -	Estimated Tons	Estimated Percent	+ / -	Estimated Tons
Paper	2.7%		26,118	3.1%		31,554
Uncoated Corrugated Cardboard	1.3%	0.9%	12,809	1.4%	0.8%	14,246
Paper Bags	0.0%	0.0%	147	0.0%	0.0%	260
Newspaper	0.1%	0.0%	532	0.1%	0.1%	898
White Ledger Paper	0.0%	0.0%	255	0.0%	0.0%	322
Other Office Paper	0.0%	0.0%	19	0.0%	0.0%	27
Magazines and Catalogs	0.2%	0.2%	1,665	0.2%	0.2%	1,978
Phone Books and Directories	0.0%	0.1%	328	0.0%	0.1%	334
Other Miscellaneous Paper - Compostable	0.0%	0.0%	143	0.0%	0.0%	170
Other Miscellaneous Paper - Other	0.5%	0.4%	4,931	0.6%	0.3%	5,830
Remainder/Composite Paper - Rigid Food & Beverage Cartons	0.0%	0.0%	138	0.0%	0.0%	204
Remainder/Composite Paper - Compostable	0.4%	0.2%	3,346	0.5%	0.3%	4,828
Remainder/Composite Paper - Other	0.2%	0.1%	1,805	0.2%	0.2%	2,457
Glass	2.6%		24,564	2.7%		27,430
Clear Glass Bottles and Containers - CRV	0.0%	0.0%	474	0.1%	0.1%	703
Clear Glass Bottles and Containers - Non-CRV	0.2%	0.1%	1,538	0.2%	0.1%	1,928
Green Glass Bottles and Containers - CRV	0.0%	0.0%	85	0.0%	0.0%	173
Green Glass Bottles and Containers - Non-CRV	0.0%	0.0%	131	0.0%	0.0%	146
Brown Glass Bottles and Containers - CRV	0.1%	0.1%	601	0.1%	0.1%	815
Brown Glass Bottles and Containers - Non-CRV	0.0%	0.0%	29	0.0%	0.0%	41
Other Colored Glass Bottles and Containers - CRV	0.0%	0.0%	3	0.0%	0.0%	3
Other Colored Glass Bottles and Containers - Non-CRV	0.0%	0.0%	45	0.0%	0.0%	43
Flat Glass	1.4%	1.0%	13,360	1.5%	1.0%	14,892
Remainder/Composite Glass	0.9%	0.7%	8,297	0.8%	0.7%	8,687
Metal	4.3%		40,753	4.6%		47,212
Tin/Steel Cans - CRV Bimetal Containers	0.0%	0.0%	22	0.0%	0.0%	50
Tin/Steel Cans - Other	0.8%	1.0%	7,406	0.8%	1.0%	7,746
Major Appliances	0.3%	0.4%	2,425	0.2%	0.4%	2,449
Used Oil Filters	0.0%	0.0%	133	0.0%	0.0%	303
Other Ferrous	1.6%	1.3%	14,808	1.6%	1.3%	16,723
Aluminum Cans - CRV	0.0%	0.0%	177	0.0%	0.0%	267
Aluminum Cans - Non-CRV	0.0%	0.0%	18	0.0%	0.0%	29
Other Non-Ferrous	0.1%	0.0%	550	0.1%	0.1%	775
Remainder/Composite Metal	1.6%	0.8%	15,214	1.8%	1.1%	18,869
Electronics	1.0%		9,507	1.0%		10,640
Brown Goods	0.3%	0.4%	3,146	0.3%	0.3%	3,334
Computer-related Electronics	0.0%	0.0%	54	0.0%	0.0%	85
Other Small Consumer Electronics	0.1%	0.2%	1,212	0.1%	0.1%	1,211
Video Display Devices - CRT	0.5%	0.7%	4,428	0.4%	0.7%	4,496
Video Display Devices - Other	0.1%	0.1%	667	0.1%	0.2%	1,515
Plastic	4.9%		46,947	5.1%		52,570
PETE Containers - CRV	0.1%	0.1%	619	0.1%	0.1%	909
PETE Containers - Non-CRV	0.1%	0.0%	482	0.1%	0.0%	626
HDPE Containers - CRV	0.0%	0.0%	101	0.0%	0.0%	158
HDPE Containers - Non-CRV	0.0%	0.0%	417	0.1%	0.0%	590
Miscellaneous Plastic Containers - CRV	0.0%	0.0%	0	0.0%	0.0%	0
Miscellaneous Plastic Containers - Non-CRV	0.0%	0.0%	434	0.1%	0.0%	539
Plastic Trash Bags	0.1%	0.1%	1,037	0.2%	0.1%	1,602
Plastic Grocery and Other Merchandise Bags	0.0%	0.0%	415	0.0%	0.0%	491
Non-Bag Commercial and Industrial Packaging Film	0.0%	0.0%	320	0.1%	0.0%	576
Film Products	0.1%	0.1%	1,119	0.1%	0.1%	1,125
Other Film - Flexible Plastic Pouches	0.0%	0.0%	78	0.0%	0.0%	112
Other Film - Other	0.2%	0.1%	2,229	0.3%	0.2%	3,105
Durable Plastic Items - #2 and #5 Bulky Rigid	0.8%	0.9%	7,784	0.8%	0.8%	8,139
Durable Plastic Items - Other	1.4%	0.7%	13,670	1.5%	0.7%	15,030
Remainder/Composite Plastic	1.9%	1.2%	18,241	1.9%	1.2%	19,569

Confidence intervals calculated at the 90% confidence level. Percentages for material types may not total 100% due to rounding.

Table 60 (continued): Composition of Residential Self-Hauled Disposed Waste Using Expanded Material Types

Material	Est. Using 2014 Sector Percentages			Est. Using 2008 Sector Percentages		
	Estimated Percent	+ / -	Estimated Tons	Estimated Percent	+ / -	Estimated Tons
Other Organic	16.5%		157,190	17.2%		175,810
Food	0.7%	0.3%	6,687	1.0%	0.4%	10,047
Leaves and Grass	2.7%	2.6%	25,584	2.9%	2.5%	29,268
Prunings and Trimmings	2.1%	1.8%	19,891	2.1%	1.7%	21,523
Branches and Stumps	2.3%	2.5%	21,507	2.3%	2.5%	23,271
Manures	1.5%	2.4%	14,359	1.4%	2.2%	14,424
Textiles	2.4%	1.1%	22,556	2.5%	1.1%	25,980
Carpet	3.9%	2.7%	36,959	3.8%	2.6%	38,447
Remainder/Composite Organic	1.0%	0.6%	9,648	1.3%	0.7%	12,849
Inerts and Other	49.3%		469,132	48.2%		493,159
Concrete	4.0%	4.1%	37,614	3.8%	3.9%	39,241
Asphalt Paving	0.0%	0.0%	0	0.0%	0.0%	0
Asphalt Roofing	0.3%	0.4%	2,898	0.4%	0.5%	4,233
Clean Dimensional Lumber	7.9%	4.2%	74,999	7.7%	4.0%	78,853
Clean Engineered Wood	6.2%	2.8%	58,799	6.0%	2.7%	61,561
Clean Pallets & Crates	3.0%	3.6%	28,967	2.9%	3.4%	29,548
Other Wood Waste	16.3%	5.4%	155,567	16.1%	5.2%	164,468
Gypsum Board	4.6%	4.3%	43,892	4.4%	4.2%	45,499
Rock, Soil and Fines	2.3%	1.8%	22,246	2.4%	1.7%	24,825
Remainder/Composite Inerts and Other	4.6%	2.6%	44,149	4.4%	2.4%	44,931
Household Hazardous Waste (HHW)	0.1%		845	0.1%		1,089
Paint	0.0%	0.0%	5	0.0%	0.0%	6
Vehicle and Equipment Fluids	0.0%	0.0%	0	0.0%	0.0%	0
Used Oil	0.0%	0.0%	38	0.0%	0.0%	87
Batteries	0.0%	0.0%	110	0.0%	0.0%	159
Mercury-Containing Items - Not Lamps	0.0%	0.0%	0	0.0%	0.0%	0
Lamps - Fluorescent and LED	0.0%	0.0%	37	0.0%	0.0%	42
Remainder/Composite Household Hazardous	0.1%	0.1%	654	0.1%	0.1%	795
Special Waste	17.4%		165,931	16.8%		171,782
Ash	0.1%	0.1%	787	0.1%	0.1%	817
Treated Medical Waste	0.0%	0.0%	0	0.0%	0.0%	0
Bulky Items	17.1%	5.7%	162,704	16.5%	5.5%	168,483
Tires	0.3%	0.3%	2,424	0.2%	0.3%	2,463
Remainder/Composite Special Waste	0.0%	0.0%	15	0.0%	0.0%	20
Mixed Residue	1.1%		10,848	1.2%		11,791
Totals	100.0%		951,833	100.0%		1,023,039
Sample Count	116			116		

Confidence intervals calculated at the 90% confidence level. Percentages for material types may not total 100% due to rounding.

The above table presents the 2014 sector percentages applied to the 2014 waste composition data and, for comparison, the sector percentages obtained in the 2008 Statewide Waste Characterization Study applied to the 2014 waste composition data. See *Special Note Regarding Sector Percentages* on Page 3 for a further explanation of the sector percentage issues.

Commercially Generated Disposed Waste

Table 61: Ten Most Prevalent Material Types in Franchised Commercial Plus Commercial Self-Hauled Disposed Waste Using Expanded Material Types

Material	Estimated Percent	Cumulative Percent	Estimated Tons
Food	15.6%	15.6%	2,402,770
Remainder/Composite Paper - Compostable	5.6%	21.2%	863,168
Other Wood Waste	5.6%	26.8%	855,950
Bulky Items	5.2%	32.0%	802,261
Clean Dimensional Lumber	4.4%	36.4%	674,097
Uncoated Corrugated Cardboard	4.3%	40.7%	665,574
Remainder/Composite Inerts and Other	3.6%	44.3%	558,685
Other Miscellaneous Paper - Other	3.4%	47.7%	516,501
Clean Pallets & Crates	3.3%	51.0%	509,925
Leaves and Grass	3.1%	54.1%	483,683
Total	54.1%		8,332,613

Any differences between *cumulative percent* figures and the sum of *estimated percent* figures are due to rounding. The above table was constructed using sector percentage data obtained from the 2014 vehicle surveys applied to 2014 composition results. See *Special Note Regarding Sector Percentages* on Page 3 for a further explanation of the sector percentage issues.

Table 62: Composition of Franchised Commercial Plus Commercial Self-Hauled Disposed Waste Using Expanded Material Types

Material	Est. Using 2014 Sector Percentages			Est. Using 2008 Sector Percentages		
	Estimated Percent	+ / -	Estimated Tons	Estimated Percent	+ / -	Estimated Tons
Paper	16.6%		2,554,320	16.0%		3,300,757
Uncoated Corrugated Cardboard	4.3%	1.5%	665,574	4.6%	1.6%	945,165
Paper Bags	0.2%	0.1%	25,838	0.1%	0.1%	29,819
Newspaper	0.4%	0.2%	66,053	0.4%	0.2%	75,527
White Ledger Paper	0.5%	0.3%	80,719	0.5%	0.3%	104,932
Other Office Paper	0.2%	0.2%	37,983	0.2%	0.2%	48,450
Magazines and Catalogs	0.5%	0.1%	72,987	0.4%	0.1%	88,821
Phone Books and Directories	0.1%	0.0%	7,862	0.0%	0.0%	9,344
Other Miscellaneous Paper - Compostable	0.3%	0.2%	42,163	0.2%	0.2%	50,038
Other Miscellaneous Paper - Other	3.4%	1.1%	516,501	3.3%	1.1%	686,254
Remainder/Composite Paper - Rigid Food & Beverage Cartons	0.4%	0.3%	65,600	0.4%	0.3%	84,932
Remainder/Composite Paper - Compostable	5.6%	1.7%	863,168	5.0%	1.5%	1,034,089
Remainder/Composite Paper - Other	0.7%	0.2%	109,873	0.7%	0.2%	143,386
Glass	2.7%		418,889	2.6%		531,001
Clear Glass Bottles and Containers - CRV	0.3%	0.1%	49,027	0.3%	0.1%	58,401
Clear Glass Bottles and Containers - Non-CRV	0.3%	0.1%	42,990	0.2%	0.1%	50,753
Green Glass Bottles and Containers - CRV	0.0%	0.0%	6,571	0.0%	0.0%	7,735
Green Glass Bottles and Containers - Non-CRV	0.1%	0.1%	19,606	0.1%	0.1%	23,899
Brown Glass Bottles and Containers - CRV	0.2%	0.1%	26,653	0.2%	0.1%	32,073
Brown Glass Bottles and Containers - Non-CRV	0.1%	0.1%	15,291	0.1%	0.2%	24,580
Other Colored Glass Bottles and Containers - CRV	0.0%	0.0%	237	0.0%	0.0%	364
Other Colored Glass Bottles and Containers - Non-CRV	0.0%	0.0%	5,920	0.0%	0.0%	7,683
Flat Glass	0.2%	0.2%	26,695	0.2%	0.2%	39,555
Remainder/Composite Glass	1.5%	2.1%	225,898	1.4%	2.0%	285,959
Metal	3.3%		500,420	3.2%		658,714
Tin/Steel Cans - CRV Bimetal Containers	0.0%	0.1%	6,719	0.0%	0.1%	8,294
Tin/Steel Cans - Other	0.4%	0.2%	68,357	0.4%	0.2%	89,100
Major Appliances	0.1%	0.1%	13,328	0.1%	0.1%	12,609
Used Oil Filters	0.0%	0.0%	571	0.0%	0.0%	530
Other Ferrous	0.9%	0.4%	144,669	1.0%	0.4%	197,106
Aluminum Cans - CRV	0.1%	0.0%	14,620	0.1%	0.0%	17,888
Aluminum Cans - Non-CRV	0.0%	0.0%	3,410	0.0%	0.0%	4,188
Other Non-Ferrous	0.6%	0.4%	91,924	0.7%	0.5%	140,863
Remainder/Composite Metal	1.0%	0.4%	156,822	0.9%	0.4%	188,137
Electronics	0.7%		103,587	0.6%		115,052
Brown Goods	0.3%	0.2%	39,913	0.2%	0.2%	48,758
Computer-related Electronics	0.1%	0.1%	20,695	0.1%	0.1%	24,208
Other Small Consumer Electronics	0.1%	0.0%	12,640	0.1%	0.1%	16,407
Video Display Devices - CRT	0.1%	0.1%	17,951	0.1%	0.1%	15,230
Video Display Devices - Other	0.1%	0.1%	12,388	0.1%	0.1%	10,450
Plastic	10.9%		1,683,948	10.5%		2,168,382
PETE Containers - CRV	0.2%	0.1%	38,469	0.2%	0.1%	46,868
PETE Containers - Non-CRV	0.3%	0.2%	47,148	0.3%	0.2%	57,727
HDPE Containers - CRV	0.1%	0.1%	7,803	0.0%	0.1%	9,613
HDPE Containers - Non-CRV	0.4%	0.2%	60,866	0.4%	0.2%	79,777
Miscellaneous Plastic Containers - CRV	0.0%	0.0%	570	0.0%	0.0%	722
Miscellaneous Plastic Containers - Non-CRV	0.5%	0.2%	80,487	0.5%	0.2%	101,063
Plastic Trash Bags	1.4%	0.2%	211,216	1.3%	0.2%	261,315
Plastic Grocery and Other Merchandise Bags	0.3%	0.0%	41,627	0.2%	0.0%	50,775
Non-Bag Commercial and Industrial Packaging Film	0.4%	0.1%	63,224	0.4%	0.2%	87,842
Film Products	0.4%	0.6%	67,218	0.6%	0.7%	113,378
Other Film - Flexible Plastic Pouches	0.1%	0.0%	8,177	0.0%	0.0%	10,055
Other Film - Other	1.6%	0.3%	247,240	1.5%	0.3%	311,595
Durable Plastic Items - #2 and #5 Bulky Rigid	0.9%	0.5%	139,267	0.9%	0.5%	175,267
Durable Plastic Items - Other	1.7%	0.7%	267,502	1.6%	0.6%	323,861
Remainder/Composite Plastic	2.6%	0.6%	403,134	2.6%	0.7%	538,523

Confidence intervals calculated at the 90% confidence level. Percentages for material types may not total 100% due to rounding.

Table 62 (continued): Composition of Franchised Commercial Plus Commercial Self-Hauled Disposed Waste Using Expanded Material Types

Material	Est. Using 2014 Sector Percentages			Est. Using 2008 Sector Percentages		
	Estimated Percent	+ / -	Estimated Tons	Estimated Percent	+ / -	Estimated Tons
Other Organic	31.4%		4,832,395	30.3%		6,243,002
Food	15.6%	2.8%	2,402,770	14.1%	2.6%	2,911,474
Leaves and Grass	3.1%	1.8%	483,683	3.3%	1.9%	676,246
Prunings and Trimmings	2.5%	1.2%	389,288	2.8%	1.5%	581,556
Branches and Stumps	1.9%	1.4%	295,252	2.1%	1.4%	425,468
Manures	1.0%	1.1%	157,285	1.0%	1.0%	197,226
Textiles	2.7%	0.9%	416,021	2.6%	0.9%	541,205
Carpet	2.0%	1.0%	314,577	2.1%	1.1%	433,988
Remainder/Composite Organic	2.4%	0.6%	373,519	2.3%	0.7%	475,840
Inerts and Other	26.6%		4,100,096	28.7%		5,912,664
Concrete	1.5%	0.6%	224,588	1.5%	0.7%	315,352
Asphalt Paving	0.5%	0.7%	70,269	0.6%	1.0%	130,364
Asphalt Roofing	1.0%	0.7%	154,630	1.1%	0.9%	217,189
Clean Dimensional Lumber	4.4%	1.8%	674,097	4.4%	1.9%	904,397
Clean Engineered Wood	2.2%	0.8%	337,929	2.2%	1.0%	452,620
Clean Pallets & Crates	3.3%	1.1%	509,925	3.9%	1.4%	811,277
Other Wood Waste	5.6%	1.2%	855,950	5.7%	1.3%	1,180,630
Gypsum Board	1.6%	0.7%	242,316	1.6%	0.8%	329,425
Rock, Soil and Fines	3.1%	1.2%	471,708	3.6%	1.4%	740,230
Remainder/Composite Inerts and Other	3.6%	1.4%	558,685	4.0%	1.6%	831,179
Household Hazardous Waste (HHW)	0.3%		42,555	0.2%		40,775
Paint	0.1%	0.2%	23,061	0.1%	0.1%	20,722
Vehicle and Equipment Fluids	0.0%	0.0%	0	0.0%	0.0%	0
Used Oil	0.0%	0.0%	661	0.0%	0.0%	565
Batteries	0.0%	0.0%	3,276	0.0%	0.0%	3,908
Mercury-Containing Items - Not Lamps	0.0%	0.0%	0	0.0%	0.0%	0
Lamps - Fluorescent and LED	0.0%	0.0%	1,215	0.0%	0.0%	1,799
Remainder/Composite Household Hazardous	0.1%	0.1%	14,341	0.1%	0.1%	13,781
Special Waste	6.1%		934,818	6.5%		1,343,591
Ash	0.1%	0.1%	11,407	0.1%	0.1%	13,755
Treated Medical Waste	0.0%	0.1%	5,118	0.0%	0.1%	7,668
Bulky Items	5.2%	1.7%	802,261	5.6%	1.9%	1,162,759
Tires	0.2%	0.2%	25,601	0.1%	0.2%	27,312
Remainder/Composite Special Waste	0.6%	0.5%	90,431	0.6%	0.6%	132,098
Mixed Residue	1.5%		225,206	1.3%		273,300
Totals	100.0%		15,396,234	100.0%		20,587,239
Sample Count	385			385		

Confidence intervals calculated at the 90% confidence level. Percentages for material types may not total 100% due to rounding.

The above table presents the 2014 sector percentages applied to the 2014 waste composition data and, for comparison, the sector percentages obtained in the 2008 Statewide Waste Characterization Study applied to the 2014 waste composition data. See *Special Note Regarding Sector Percentages* on Page 3 for a further explanation of the sector percentage issues.

Residentially Generated Disposed Waste

Table 63: Ten Most Prevalent Material Types in Franchised Residential Plus Residential Self-Hauled Disposed Waste Using Expanded Material Types

Material	Estimated Percent	Cumulative Percent	Estimated Tons
Food	20.6%	20.6%	3,188,409
Remainder/Composite Paper - Compostable	7.5%	28.1%	1,161,353
Remainder/Composite Organic	6.1%	34.3%	949,946
Textiles	5.3%	39.6%	818,690
Mixed Residue	4.5%	44.1%	701,789
Leaves and Grass	4.5%	48.5%	689,241
Other Wood Waste	4.3%	52.9%	671,369
Other Miscellaneous Paper - Other	4.1%	57.0%	630,476
Prunings and Trimmings	3.7%	60.7%	572,973
Bulky Items	3.6%	64.3%	563,079
Total	64.3%		9,947,326

Any differences between *cumulative percent* figures and the sum of *estimated percent* figures are due to rounding. The above table was constructed using sector percentage data obtained from the 2014 vehicle surveys applied to 2014 composition results. See *Special Note Regarding Sector Percentages* on Page 3 for a further explanation of the sector percentage issues.

Table 64: Composition of Franchised Residential Plus Residential Self-Hauled Disposed Waste Using Expanded Material Types

Material	Est. Using 2014 Sector Percentages			Est. Using 2008 Sector Percentages		
	Estimated Percent	+ / -	Estimated Tons	Estimated Percent	+ / -	Estimated Tons
Paper	18.2%		2,813,413	18.3%		1,876,239
Uncoated Corrugated Cardboard	1.9%	0.7%	299,369	2.0%	0.8%	207,315
Paper Bags	0.3%	0.1%	44,790	0.3%	0.1%	32,440
Newspaper	2.0%	1.2%	306,913	2.0%	1.4%	209,990
White Ledger Paper	0.3%	0.1%	40,919	0.3%	0.1%	27,287
Other Office Paper	0.4%	0.2%	65,862	0.4%	0.1%	40,727
Magazines and Catalogs	0.7%	0.2%	105,178	0.7%	0.1%	69,586
Phone Books and Directories	0.0%	0.0%	6,721	0.0%	0.0%	4,246
Other Miscellaneous Paper - Compostable	0.2%	0.1%	26,778	0.2%	0.1%	17,330
Other Miscellaneous Paper - Other	4.1%	1.1%	630,476	4.0%	1.1%	411,054
Remainder/Composite Paper - Rigid Food & Beverage Cartons	0.3%	0.1%	38,808	0.2%	0.1%	24,912
Remainder/Composite Paper - Compostable	7.5%	1.8%	1,161,353	7.5%	1.7%	766,995
Remainder/Composite Paper - Other	0.6%	0.2%	86,247	0.6%	0.2%	64,357
Glass	2.2%		345,274	2.3%		239,529
Clear Glass Bottles and Containers - CRV	0.4%	0.1%	57,737	0.4%	0.1%	40,627
Clear Glass Bottles and Containers - Non-CRV	0.7%	0.1%	113,685	0.7%	0.1%	75,781
Green Glass Bottles and Containers - CRV	0.1%	0.0%	9,682	0.1%	0.0%	6,268
Green Glass Bottles and Containers - Non-CRV	0.2%	0.1%	35,524	0.2%	0.1%	20,033
Brown Glass Bottles and Containers - CRV	0.3%	0.1%	54,089	0.4%	0.1%	36,741
Brown Glass Bottles and Containers - Non-CRV	0.1%	0.0%	15,399	0.1%	0.0%	10,782
Other Colored Glass Bottles and Containers - CRV	0.0%	0.0%	2,478	0.0%	0.0%	1,943
Other Colored Glass Bottles and Containers - Non-CRV	0.0%	0.0%	3,549	0.0%	0.0%	1,854
Flat Glass	0.1%	0.1%	15,786	0.2%	0.1%	16,955
Remainder/Composite Glass	0.2%	0.1%	37,345	0.3%	0.1%	28,545
Metal	3.0%		456,607	3.0%		305,788
Tin/Steel Cans - CRV Bimetal Containers	0.1%	0.1%	11,287	0.1%	0.1%	8,502
Tin/Steel Cans - Other	0.8%	0.2%	118,086	0.8%	0.2%	80,526
Major Appliances	0.2%	0.4%	36,922	0.2%	0.2%	16,391
Used Oil Filters	0.0%	0.0%	683	0.0%	0.0%	569
Other Ferrous	0.7%	0.2%	103,924	0.7%	0.2%	70,826
Aluminum Cans - CRV	0.1%	0.0%	16,282	0.1%	0.0%	11,511
Aluminum Cans - Non-CRV	0.1%	0.0%	12,922	0.1%	0.0%	9,110
Other Non-Ferrous	0.4%	0.1%	65,554	0.4%	0.1%	40,146
Remainder/Composite Metal	0.6%	0.2%	90,947	0.7%	0.2%	68,207
Electronics	1.1%		170,291	1.1%		115,446
Brown Goods	0.3%	0.3%	44,502	0.3%	0.2%	26,384
Computer-related Electronics	0.2%	0.1%	24,954	0.2%	0.1%	17,131
Other Small Consumer Electronics	0.4%	0.1%	56,292	0.4%	0.1%	38,050
Video Display Devices - CRT	0.2%	0.2%	28,708	0.2%	0.2%	23,651
Video Display Devices - Other	0.1%	0.1%	15,835	0.1%	0.1%	10,230
Plastic	9.9%		1,531,994	10.1%		1,035,160
PETE Containers - CRV	0.3%	0.1%	46,334	0.3%	0.1%	30,982
PETE Containers - Non-CRV	0.4%	0.1%	65,251	0.4%	0.1%	43,951
HDPE Containers - CRV	0.0%	0.0%	3,583	0.0%	0.0%	2,755
HDPE Containers - Non-CRV	0.4%	0.1%	66,938	0.4%	0.1%	44,548
Miscellaneous Plastic Containers - CRV	0.0%	0.0%	6,494	0.0%	0.0%	3,705
Miscellaneous Plastic Containers - Non-CRV	0.6%	0.1%	86,186	0.6%	0.2%	59,853
Plastic Trash Bags	1.1%	0.1%	171,914	1.1%	0.1%	118,001
Plastic Grocery and Other Merchandise Bags	0.7%	0.1%	115,767	0.8%	0.1%	77,523
Non-Bag Commercial and Industrial Packaging Film	0.1%	0.1%	19,968	0.1%	0.1%	14,818
Film Products	0.0%	0.0%	6,176	0.1%	0.0%	5,517
Other Film - Flexible Plastic Pouches	0.2%	0.1%	34,996	0.2%	0.2%	23,811
Other Film - Other	1.6%	0.2%	253,064	1.7%	0.2%	177,750
Durable Plastic Items - #2 and #5 Bulky Rigid	0.5%	0.2%	72,959	0.5%	0.2%	53,236
Durable Plastic Items - Other	1.3%	0.4%	203,083	1.2%	0.3%	118,848
Remainder/Composite Plastic	2.5%	0.3%	379,281	2.5%	0.3%	259,861

Confidence intervals calculated at the 90% confidence level. Percentages for material types may not total 100% due to rounding.

Table 64 (continued): Composition of Franchised Residential Plus Residential Self-Hauled Disposed Waste Using Expanded Material Types

Material	Est. Using 2014 Sector Percentages			Est. Using 2008 Sector Percentages		
	Estimated Percent	+ / -	Estimated Tons	Estimated Percent	+ / -	Estimated Tons
Other Organic	43.5%		6,725,659	42.5%		4,371,386
Food	20.6%	1.7%	3,188,409	21.1%	1.5%	2,171,890
Leaves and Grass	4.5%	1.6%	689,241	3.6%	1.1%	372,375
Prunings and Trimmings	3.7%	1.5%	572,973	2.8%	1.0%	286,957
Branches and Stumps	1.5%	1.2%	233,242	1.2%	0.8%	119,405
Manures	0.1%	0.1%	17,522	0.2%	0.2%	17,648
Textiles	5.3%	1.1%	818,690	5.6%	1.2%	573,019
Carpet	1.7%	0.7%	255,636	1.7%	0.6%	171,962
Remainder/Composite Organic	6.1%	0.8%	949,946	6.4%	0.8%	658,131
Inerts and Other	13.1%		2,032,742	13.2%		1,352,874
Concrete	1.0%	0.5%	148,598	1.0%	0.5%	99,935
Asphalt Paving	0.0%	0.0%	0	0.0%	0.0%	0
Asphalt Roofing	0.4%	0.5%	68,606	0.3%	0.3%	33,960
Clean Dimensional Lumber	2.0%	1.3%	301,999	1.8%	0.9%	185,553
Clean Engineered Wood	1.2%	0.8%	185,293	1.2%	0.5%	118,887
Clean Pallets & Crates	0.9%	0.7%	140,148	1.0%	0.8%	105,604
Other Wood Waste	4.3%	1.7%	671,369	4.6%	1.3%	470,102
Gypsum Board	0.5%	0.3%	84,687	0.7%	0.4%	72,259
Rock, Soil and Fines	1.8%	0.6%	278,649	1.5%	0.4%	155,899
Remainder/Composite Inerts and Other	1.0%	0.4%	153,394	1.1%	0.4%	110,675
Household Hazardous Waste (HHW)	0.4%		67,014	0.4%		37,685
Paint	0.2%	0.2%	25,890	0.1%	0.1%	10,692
Vehicle and Equipment Fluids	0.0%	0.0%	219	0.0%	0.0%	88
Used Oil	0.0%	0.0%	749	0.0%	0.0%	374
Batteries	0.1%	0.0%	8,611	0.1%	0.0%	6,986
Mercury-Containing Items - Not Lamps	0.0%	0.0%	8	0.0%	0.0%	7
Lamps - Fluorescent and LED	0.0%	0.1%	7,013	0.1%	0.1%	5,478
Remainder/Composite Household Hazardous	0.2%	0.1%	24,524	0.1%	0.1%	14,059
Special Waste	4.0%		623,261	4.5%		459,919
Ash	0.0%	0.0%	4,731	0.0%	0.0%	3,654
Treated Medical Waste	0.2%	0.3%	29,791	0.2%	0.4%	22,977
Bulky Items	3.6%	1.8%	563,079	4.0%	1.5%	411,390
Tires	0.1%	0.1%	13,792	0.1%	0.1%	11,996
Remainder/Composite Special Waste	0.1%	0.0%	11,868	0.1%	0.0%	9,903
Mixed Residue	4.5%		701,789	4.7%		483,014
Totals	100.0%		15,468,045	100.0%		10,277,040
Sample Count	369			369		

Confidence intervals calculated at the 90% confidence level. Percentages for material types may not total 100% due to rounding.

The above table presents the 2014 sector percentages applied to the 2014 waste composition data and, for comparison, the sector percentages obtained in the 2008 Statewide Waste Characterization Study applied to the 2014 waste composition data. See *Special Note Regarding Sector Percentages* on Page 3 for a further explanation of the sector percentage issues.